



2019
Furniture for
Early Learning Spaces

N a t u r a l L i n e

EduFun® welcomes you to our Kindergarten Spaces Catalog. Here you will find complete solutions for pre-school and kindergarten learning spaces. Spaces where children can play, explore, discover and grow happily.

EduFun® provides a full range of products: chairs, tables, storage units, reading corners, play corners, role-play furniture, and even a puppet theatre. The furniture in these pages is ergonomically designed for active children in their early years to encourage healthy posture. With all modular designs, the natural-look pieces transform classes into creative expressions, with infinite arrangements, and infinite possibilities. Durable designs ensure years of safe and practical furniture.

EduFun® brings the highest quality furniture with the best designs into all classrooms. You'll find all the pieces are affordable and can be purchased individually, so you can buy only what you need and add on as your institution grows.

EduFun® now has subsidiary companies in Germany, Australia, Canada, KSA, Dubai and Egypt, distributing products to more than 25 countries.



Complete Natural Solutions for Kindergarten Spaces



Table of Contents

Introduction	03
Chairs	07
Elegance	13
Deluxe	15
Star	17
Woody curvy	19
Woody	21
Ladder	23
Classic	25
Classic Plus	27
Classic S	29
Smart	31
Action	35
Dynamic	37
Simple	39
Flexo L	43
Flexo N	45
Deluxe - Teacher	48
Simple - Teacher	48
Stool & Benches	49
Tables	51
Flexo	57
Multi	63
Curvy	69
Elegance	75
Toddler	83
Chairs	85
Tables	89
Storage Units	99
Flexo	101
Ultimate N	109
Ultra	113
Materials Cabinets	119
Book Shelving Units	123
Room Dividers	125
Platform	129
Role Play	133
Children Play Kitchen	135
Fantasy dress-up unit	137
Children's lounge	138
Pretend market stall	139
Activity Play Table	141
Soft Seating	143
Soft Play	147
Wooden Blocks	153

Welcome to our World

The background of our company goes back a long way, as the founders were educators with many years of experience in establishing schools. They believed in education as the best way for developing societies and people. This belief was the motivation to establish our company, and is still driving it through years and years of success.



Children are our priority

Our products are always designed with children in mind. With our experience in the educational field, we understand carefully children's needs and how classroom furniture can stimulate their development. Classrooms should be inviting, environments that make children feel good to be there.



We listen carefully

At EduFun®, we strive to serve and support our customers around the world. We always listen to our customers concerns and demands. We develop our products upon their needs. You will find our furniture is modular and able to adjust in order to be able to change the learning environment all the time.



We care about our environment

Since the first day, we chose to use wood in our production, to create a healthy warm environment for children. Wood is the most environmentally friendly raw material, which are healthy for our climate, prevent climate changes and has Zero Waste. The beauty of wood is that it engages all of our senses. It is warm, rich and affecting, and its surface has a tactile and sensuous strength. We use real wood from sustainable forestry to help protect our environment. Contributing to the preservation of the environment is almost of our responsibility.



Production

Since EduFun® first began, we have been expanding our production lines to fulfill growing demand. Likewise, the collections of the EDUFUN range have been continuously expanding to meet our customers' desires.

New state of the art machines have been added to our production lines offering quality and on-time production. We are able to develop new product ranges with the execution of OME products with our factories and our four production lines (solid wood, panel board, tube bending, wooden toys and puzzle).

- 1 Solid Wood Production Line
- 2 Panel Board Production Line
- 3 Tube Bending Production Line
- 4 Educational Resources Production Line



Materials

EduFun® aims to build sustainable long-lasting furniture for the most active and ruthless children. Besides smart designs, durability depends on using the highest quality materials. To that end, Edu fun imports high quality natural European Beech wood and the longest lasting non-toxic German paints safety lacquers. We spare no expense to make certain you're getting the best products made of the highest quality materials.



Design

EduFun® designs furniture for preschool and kindergarten children, for educators, for learning institutions, to make everyone at your school safe, happy and comfortable from the start of the day till the last moment of the day.

EduFun® designs are synonymous with creative, versatile, and practical learning spaces. Our Research and Development Department has collaborated with experts from all-over the world to research, develop and create innovative products.

Ergonomically designed furniture for growing children. Storage units of all kinds for organized and efficient classrooms. Reading, play corners and role play furniture for a complete and holistic learning experience. The finest materials, vibrant colors and exquisite textures come together for relentless beauty. Durability for furniture that looks new for years to come. EduFun® designed for you all that you dream of in your preschool and kindergarten learning spaces.



Light Beech Wood



Plastic Glides



Ergonomically curved seat

Soft Edges

Ergonomically Designed
International Standards BS EN1729

Dreams can come true

We have a very wide range of products that can provide any customer with what they need. Our products vary from chairs, tables, storage units, room dividers, platforms and role play furniture. However, sometimes special specifications are requested. With our production capabilities, we can make your dreams come true.



Standards

EduFun® meets the latest high international standards of safety for our whole product range. Compliant with international standards, even the strict European CE standards, our products are safe for preschool and kindergarten children. We worry about your children's safety, so you do not have to. All of our products and production facilities are certified with the following international and European standards:

- EN 71
- ISO 9001
- ISO 14001
- OHSAS 18001



EN 71



ISO 9001
ISO 14001
OHSAS 18001

Central Location

Edu fun® group is streamlining its activities to keep pace with the growing markets and is becoming a leader in the region and as an international player. As a place to do business, and as a hub for the region and beyond, the United Arab Emirates (UAE) continues to be increasingly important, relevant and attractive to businesses from around the world. For these reasons, we have moved our head office to UAE. EduFun® produces and ships from Egypt, the historic hub of trade and shipments. With its northern ports on the Mediterranean Sea to serve Europe and the Americas and eastern ports on the Red Sea to serve Africa, Asia and Australia is centrally located, meaning you get your order in record time.



Come Visit Us

We love getting visitors. Come to Egypt to see our facilities and see the Pyramids and Coral Reefs while you are here, or vice versa. Either way stop by and say hi. Coming with a large group? Schedule a tour of the manufacturing facilities. Come see where dreams are transformed into reality. Prefer to play and shop than see manufacturing sites? Come to Dubai and visit us in our largest worldwide showroom. More of a playground than a showroom, let your imagination run wild, then run wild after it. Arrange and rearrange as much as you like. Try out every chair and table. Let the child in you have fun designing your own learning space.



Trade agreements

Egypt is a signatory to several multilateral trade agreements, which give a great potential to its export products. Egypt's Membership in Multilateral Trade Agreements includes Agadir, the Common Market for Eastern and Southern Africa (COMESA), the Euro-Med Partnership and the Greater Arab Free Trade Area (GAFTA).

Euro.1

Euro.1 also known as a movement certificate enables importers in certain countries to import goods at a reduced or nil rate of import duty under trade agreements between the EU and beneficiary countries. Signed in 2001 it allows products to be shipped from Egypt to



Chairs & Tables







We design all of our furniture collection according to the European standards for 'chairs and tables for educational institutions' which was approved in January 2007. Children should always use the appropriate size of chairs or table to ensure good posture and prevent causing problems or distortions for them while growing. Ergonomic seating requires adjustable furniture to suits different body heights.

In this table you can choose the correct seat and table height suitable for the student age:

Children`s ages	0 - 2		2 - 3	2 - 4	4 - 6	6 - 8	8 - 11
Chairs & Tables Symbol	C 01	C 02	C 0	C 1	C 2	C 3	C 4
Chairs seat height	13 cm	17 cm	21 cm	26 cm	31 cm	35 cm	38 cm
Tables height - Fixed legs	30 cm	36 cm	40 cm	46 cm	53 cm	59 cm	64 cm
Tables height - Adjustable legs							

Toddler Chairs & Tables
Pages : 86 - 101



Solid beech wood Chairs



Elegance



Deluxe



Star



Woody curvy



Woody



Ladder



Classic



Classic Plus



Classic S



Smart



■ Solid Beech Wood Chairs

- Elegance
- Deluxe
- Star
- Woody curvy
- Woody
- ladder
- Classic
- Classic plus
- Classic s
- Smart



Elegance Chair

These beautifully crafted stackable chairs would look great in any classroom. Each chair is made of solid, top-quality lacquered beech wood and is built to last. Five convenient seat heights are available to correspond with Elegance tables. Available with arms.



Ergonomic seat



Ergonomic backrest



Soft Edges



Stackable



Protective Glides



Arm



Chairs & Tables Height	Tables	Chairs
○ C0	40 cm	21 cm
● C1	46 cm	26 cm
● C2	53 cm	31 cm
● C3	59 cm	35 cm
● C4	64 cm	38 cm



○ C0 28.5 x 28.5 cm - H. 21 cm
43201



● C1 28.5 x 28.5 cm - H. 26 cm
43202



● C2 30 x 30 cm - H. 31 cm
43203



● C3 30 x 30 cm - H. 35 cm
43204



● C4 36 x 36 cm - H. 38 cm
43205



○ C0 28.5 x 28.5 cm - H. 21 cm
43206



● C1 28.5 x 28.5 cm - H. 26 cm
43207



● C2 30 x 30 cm - H. 31 cm
43208



● C3 30 x 30 cm - H. 31 cm
43209



● C4 36 x 36 cm - H. 38 cm
43210

Available for toddlers
Page no. 94



Deluxe Chair

An ergonomic chair that will last for generations. Each chair is made of solid, top-quality lacquered beech wood & plywood. There are five different heights to be suitable for different aged children. Can be stacked for saving space. Available with arms.



Ergonomic seat & backrest



Soft Edges



Stackable



Protective Glides



Arm



Chairs & Tables Height	Tables	Chairs
○ C0	40 cm	21 cm
● C1	46 cm	26 cm
● C2	53 cm	31 cm
● C3	59 cm	35 cm
● C4	64 cm	38 cm



C0 28.5 x 28.5 cm - H. 21 cm
43270



C1 28.5 x 28.5 cm - H. 26 cm
43275



C2 30 x 30 cm - H. 31 cm
43280



C3 30 x 30 cm - H. 35 cm
43285



C4 36 x 36 cm - H. 38 cm
43284



C0 28.5 x 28.5 cm - H. 21 cm
43265



C1 28.5 x 28.5 cm - H. 26 cm
43266



C2 30 x 30 cm - H. 31 cm
43267



C3 30 x 30 cm - H. 35 cm
43286



C4 36 x 36 cm - H. 38 cm
43269

Available for toddlers
Page no. 94



Star Chair

The Star Chair boasts an ultra-modern design, manufactured with a high quality beech wood frame. Ergonomically shaped back and seat give maximum comfort and ease of use. Seats are available in 3 sizes.



Massive beech curved seat



Comfort birch plywood backrest



Soft Edges



Protective Glides



Chairs & Tables Height	Tables	Chairs
● C2	53 cm	31 cm
● C3	59 cm	35 cm
● C4	64 cm	38 cm



C2 32 x 32 cm - H. 31 cm
48120



C3 32 x 32 cm - H. 35 cm
48121



C4 36 x 36 cm - H. 38 cm
48125



Woody Curvy Chair

This curved woody chair combines the durability with curved edges for softer look. The ergonomic designs provide proper back support. It is suitable for children to move these chairs around. Seats are available in 5 sizes.



Massive beech curved seat



Curved top & mid rail
Ergonomic backrest



Soft Edges



Protective Glides



Chairs & Tables Height	Tables	Chairs
○ C0	40 cm	21 cm
● C1	46 cm	26 cm
● C2	53 cm	31 cm
● C3	59 cm	35 cm
● C4	64 cm	38 cm



○ C0 27 x 25 cm - H. 21 cm
43103



● C1 27 x 25 cm - H. 26 cm
43104



● C2 32 x 32 cm - H. 31 cm
43107



● C3 32 x 32 cm - H. 35 cm
43109



● C4 36 x 36 cm - H. 38 cm
43108



Woody Chair

These chairs are perfect companions to our wooden student desks (Elegance- Classic). Chairs have ergonomic designs and provide proper back support. Children can easily move these light chairs around. Seats are available in 5 sizes.



Massive beech curved seat



Curved top & mid rail
Ergonomic backrest



Soft Edges



Protective Glides



Chairs & Tables Height	Tables	Chairs
○ C0	40 cm	21 cm
● C1	46 cm	26 cm
● C2	53 cm	31 cm
● C3	59 cm	35 cm
● C4	64 cm	38 cm



○ C0 27 x 25 cm - H. 21 cm
43213



● C1 27 x 25 cm - H. 26 cm
43214



● C2 30 x 32 cm - H. 31 cm
43215



● C3 30 x 32 cm - H. 35 cm
43216



● C4 36 x 36 cm - H. 38 cm
48101



Ladder-Back Chair **NEW**

A classic timeless chair that was redesigned for children. This chair encourages good posture, in addition to the curved back legs that prevent from tipping. Three rails properly spaced for child safety and easy lifting. Its strong solid construction, safe edges and environmentally friendly finish make it a great choice.



Massive beech curved seat



Curved top & rails
Ergonomic backrest



Soft Edges



Protective Glides



Chairs & Tables Height	Tables	Chairs
○ C0	40 cm	21 cm
● C1	46 cm	26 cm
● C2	53 cm	31 cm
● C3	59 cm	35 cm
● C4	64 cm	38 cm



○ C0 28.5 x 30 - H.21 cm
43295

● C1 28.5 x 30 - H.26 cm
43296

● C2 32 x 32 cm - H.31 cm
43297

● C3 32 x 32 cm - H.35 cm
43298

● C4 36 x 36 cm - H.38 cm
43299



Classic Chair

Top quality chairs that will last for generations. These Classic chairs are made with a solid beech wooden frame, strong enough for even an adult to stand on. Seats are made of laminated MDF board. Seats are available in 5 sizes.



Beige HPL Laminated MDF



Ergonomic backrest



Soft Edges



Protective Glides



Chairs & Tables Height	Tables	Chairs
○ C0	40 cm	21 cm
● C1	46 cm	26 cm
● C2	53 cm	31 cm
● C3	59 cm	35 cm
● C4	64 cm	38 cm



○ C0 28.5 x 28.5 cm - H. 21 cm
43115

● C1 28.5 x 28.5 cm - H. 26 cm
43116

● C2 30 x 30 cm - H. 31 cm
43117

● C3 30 x 30 cm - H. 35 cm
43118

● C4 36 x 36 cm - H. 38 cm
43119



Classic Plus Chair

Natural beech wood with HQ finishes, this very light and sturdy design offers durability and ease of movement. Seats are available in 5 sizes.



Birch Plywood seat



Curved backrest



Soft Edges



Protective Glides



Chairs & Tables Height	Tables	Chairs
○ C0	40 cm	21 cm
● C1	46 cm	26 cm
● C2	53 cm	31 cm
● C3	59 cm	35 cm
● C4	64 cm	38 cm



○ C0 28.5 x 28.5 cm - H. 21 cm
43120

● C1 28.5 x 28.5 cm - H. 26 cm
43121

● C2 30 x 30 cm - H. 31 cm
43122

● C3 30 x 30 cm - H. 35 cm
43123

● C4 36 x 36 cm - H. 38 cm
43124



Classic S Chair

This chair combines all the advantages of the classic chair in addition to stacking. It is a top quality chair that will last for generations. The frame is made of solid beech wooden and the seat is made from laminated MDF boards. This durable chair can easily bear the weight of an adult to stand on. Leg-tips have plastic caps to prevent noise and marring of floor surface when moved.



Birch Plywood seat



Curved backrest



Soft Edges



Stackable



Protective Glides



Chairs & Tables Height	Tables	Chairs
○ C0	40 cm	21 cm
● C1	46 cm	26 cm
● C2	53 cm	31 cm
● C3	59 cm	35 cm
● C4	64 cm	38 cm



○ C0 28.5 x 28.5 cm - H. 21 cm
43140

● C1 28.5 x 28.5 cm - H. 26 cm
43141

● C2 30 x 30 cm - H. 31 cm
43142

● C3 30 x 30 cm - H. 35 cm
43143

● C4 36 x 36 cm - H. 38 cm
43144



Smart Chair **NEW**

An ergonomically curved seat and backrest, which will provide comfort for children. Each chair is made of solid, top-quality lacquered beech wood & plywood that will last for generations. Available in five different heights. Can be stacked for saving space.



Ergonomic seat & backrest



Soft Edges



Stackable



Protective Glides



Chairs & Tables Height	Tables	Chairs
○ C0	40 cm	21 cm
● C1	46 cm	26 cm
● C2	53 cm	31 cm
● C3	59 cm	35 cm
● C4	64 cm	38 cm



C0 28.5 x 28.5 cm - H. 21 cm
42990

C1 28.5 x 28.5 cm - H. 26 cm
42991

C2 30 x 30 cm - H. 31 cm
42992

C3 30 x 30 cm - H. 35 cm
42993

C4 36 x 36 cm - H. 38 cm
42994



■ Metal & Plywood Chairs



■ Metal & Plywood Chairs

- Action
- Dynamic
- Simple



Action Chair

Modern and Ergonomically designed back and seat to increase seating comfort. The environmental friendly plywood seat surface resists scratches and is easy to clean. Glides guarantee stability and minimum abrasion on all types of floors. The design of legs makes them stackable for easy storage.



Curved Birch plywood seat & backrest



Plastic Glides



Stackable



Plastic Glides



Metal Frame Colors	Grey	Beige
--------------------	------	-------



Chairs & Tables Height	Tables	Chairs
● C2	53 cm	31 cm
● C3	59 cm	35 cm
● C4	64 cm	38 cm



C2 30 x 30 cm - H.31 cm
43507

C3 30 x 30 cm - H.35 cm
43508

C4 36 x 36 cm - H.38 cm
48325



Dynamic Chair

Sturdy, durable & light chair. Constructed with superior formed metal pipes. Ergonomically designed back and seat to increase seating comfort. Seat and back surface are made from environmental friendly plywood for comfort seating. The design of legs makes them stackable for easy storage.



Curved Birch plywood seat & backrest



Plastic Glides



Stackable



Plastic Glides



Metal Frame Colors	Grey	Beige
--------------------	------	-------



Chairs & Tables Height	Tables	Chairs
● C2	53 cm	31 cm
● C3	59 cm	35 cm
● C4	64 cm	38 cm



C2 34 x 34 cm - H.31 cm
43502



C3 34 x 34 cm - H.35 cm
43503



C4 38 x 34 cm - H.38 cm
48165



Simple Chair

Sturdy, durable and light chairs. Chairs are constructed with superior formed metal pipes, seat and back from environmental-friendly plywood for comfortable seating. Chairs are stackable or put on table-top allowing easy classroom cleaning.



Curved Birch plywood seat & backrest



Plastic Cap



Stackable



Metal Frame Colors	Grey	Beige
--------------------	------	-------



Chairs & Tables Height	Tables	Chairs
● C2	53 cm	31 cm
● C3	59 cm	35 cm
● C4	64 cm	38 cm



● C2 32 x 32 cm - H. 31 cm
43505

● C3 36 x 38 cm - H. 35 cm
43506



■ Metal & Plastic Chairs



Flexo L

Flexo N



■ Metal & Plastic Chairs

- Flexo N
- Flexo L



Flexo L Chair

Modern and Ergonomically designed plastic shell to increase seating comfort. The robust seat surface resists scratches and is easy to clean. Glides guarantee stability and minimum abrasion on all types of floors. The design of legs makes them stackable for easy storage.



Ergonomic Plastic Shell



Plastic Glides

Metal Frame Colors	Grey	Beige
--------------------	------	-------



Chairs & Tables Height	Tables	Chairs
● C2	53 cm	31 cm
● C3	59 cm	35 cm
● C4	64 cm	38 cm



C2 30 x 32 cm - H.31 cm
43527

C3 30 x 32 cm - H.35 cm
43528



Flexo N Chair

Modern and Ergonomically designed plastic shell to increase seating comfort. The robust seat surface resists scratches and is easy to clean. Glides guarantee stability and minimum abrasion on all types of floors. The design of legs makes them stackable for easy storage.



Ergonomic Plastic Shell



Plastic Cap



Metal Frame Colors	Grey	Beige
--------------------	------	-------



Chairs & Tables Height	Tables	Chairs
● C2	53 cm	31 cm
● C3	59 cm	35 cm
● C4	64 cm	38 cm



C2 35 x 32 cm - H. 31 cm
43525

C3 35 x 32 cm - H. 35 cm
43526



Teacher Chair

A great item for all teachers and child caregivers! This chair is designed to keep adults comfortable while at kid-height. The seat height is perfect for sitting at the same level as young learners. Unlike standard child-sized chairs, the adult-sized seat and back provide appropriate room for adults to sit. Made of solid beechwood.



Teacher **Deluxe** Chair

Ergonomically designed chairs that will last for generations. Each chair is made of solid, top-quality lacquered beech wood & plywood. Chairs have a curved seat and back rest.



Stackable



C4 36 x 36 cm - H.38 cm
43281

Teacher **Simple** Chair

Sturdy, durable and light chairs. Chairs are constructed with superior formed metal pipes, seat and back from environmental-friendly plywood for comfortable seating. Chairs are stackable or put on table-top allowing easy classroom cleaning.



Stackable



C4 36 x 38 cm - H.38 cm
48428

Stool

A very high quality piece of furniture. This stool is made of solid Beech wood frame and laminated plywood seat. Stool legs have double dowel connection lines to guarantee maximum stability. Curved leg design has no corners on which little ones can get themselves caught. Easy to assemble for storage. The neutral tone makes them perfect companions with many tables. The doweled plastic glides are gentle to the floor even after years of use.



Stackable



C0 ø 34 cm - H. 21 cm
43320



C1 ø 34 cm - H. 26 cm
43321



C2 ø 34 cm - H. 30 cm
43322



C3 ø 34 cm - H. 35 cm
43323

Deluxe Bench

This bench is made of solid Beech wood frame with laminated plywood seat. There are no sharp corners for safety. The neutral tone makes it compatible with many tables. Gentle to the floor Doweled plastic glides even after years of use. Its construction assures strength, stability and support.



C1	96.5 x 25 cm - H. 26 cm	43286
C2	96.5 x 31 cm - H. 31 cm	43287
C3	96.5 x 31 cm - H. 35 cm	43288

Elegance Stool & Bench

This stool & bench is made of solid Beech wood frame with laminated plywood seat. There are no sharp corners so children won't catch toes or clothes. The neutral tone makes it compatible with many tables. Gentle to the floor Doweled plastic glides even after years of use. Its construction assures strength, stability and support.



Elegance Stool



Elegance Bench

Elegance Stool

C0	32 x 33 cm - H. 21 cm	43330
C1	32 x 33 cm - H. 26 cm	43331
C2	32 x 33 cm - H. 31 cm	43332
C3	32 x 33 cm - H. 35 cm	43333
C4	32 x 33 cm - H. 38 cm	43334

Elegance Bench

C0	96 x 33 cm - H. 21 cm	43335
C1	96 x 33 cm - H. 26 cm	43336
C2	96 x 33 cm - H. 31 cm	43337
C3	96 x 33 cm - H. 35 cm	43338
C4	96 x 33 cm - H. 38 cm	43339

Tables





Flexo Tables

Multi Tables

Curvy Tables



As everyone has his/her own choices, we have enabled you to choose your table just as you like! Choose the table-top material and then decide if you want a fixed or adjustable leg. Also you can decide if you want coasters (in two legs) or glides.



=



Wood/Metal legs

These legs can be adjusted according to children different heights. There are two legs you can choose from. The first leg can be used from (C0 – C2) stage and the second leg can be used from (C2- C4) stage. It is ideal for mixed age classrooms.



Available with or without Lockable Casters



Metal tube welded to bracket angle



Metal insert & Adjustable PP glide

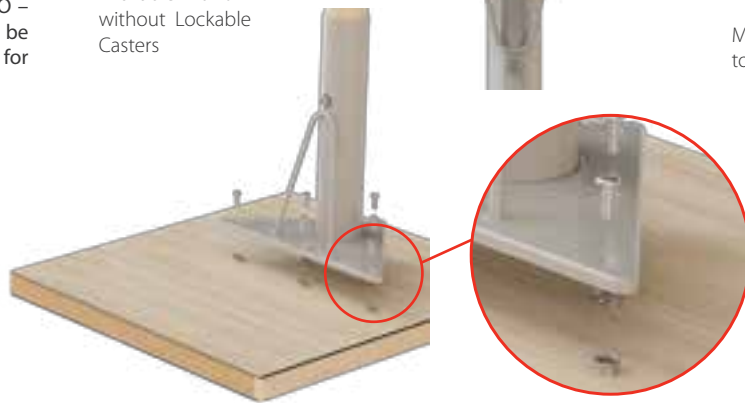

Metal insert & hex heads screws

Adjustable Leg Heights

- 64 cm
- 59 cm
- 53 cm
- 46 cm
- 40 cm

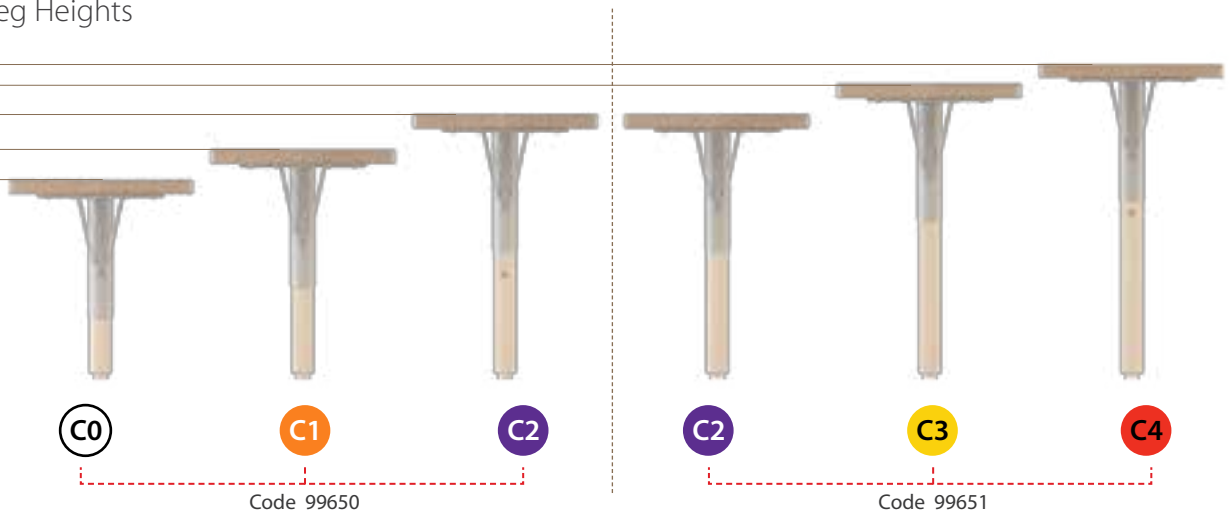

Metal legs

There are five different heights for these metal legs which is convenient to children different heights.



Available with or without Lockable Casters



Adjustable P.P glide

Available for Size **C0 to C4**

- 64 cm
- 59 cm
- 53 cm
- 46 cm
- 40 cm

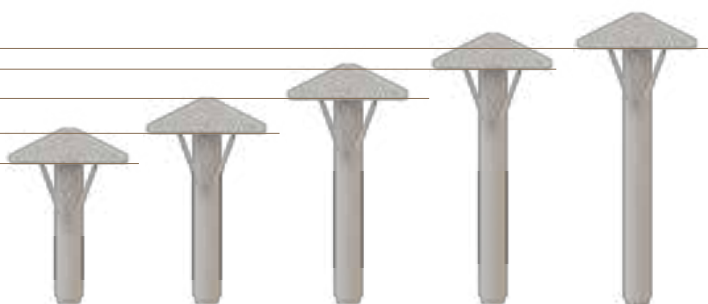

Metal tube welded to bracket angle

Metal insert & hex heads screws



28mm MDF Laminated HPL solid beech edges

Table -Top Option (1)

Table top 28mm thickness made from extremely strong medium density fiberboard (MDF) insulation , stiff , has no knots , will produce fine and better edges and tops laminated with high pressure laminated HPL (under heat (90-80 Celsius) and pressure (250 kgs/m2) - (NAF) no added formaldehyde, (Beige color or sand ash wood theme)
Edges made from solid beech wood painted with protective varnish, gently and safety rounded edges



28mm MDF Laminated HPL Lacquer and varnish edges

Table -Top Option (2)

Table top 28mm thickness made from extremely strong medium density fiberboard (MDF) insulation , stiff , has no knots , will produce fine and better edges and tops laminated with high pressure laminated HPL under heat (90-80 Celsius) and pressure (250 kgs/m2) - (NAF) no added formaldehyde, (Beige color or sand ash wood theme).
Edges painted with protective lacquer and varnish, gently smoothed and safety rounded edges



Flexo Tables

These flexible movable creative tables combine contemporary looks, functionality as well as flexibility and encourage social behaviour, creativity and cooperation among students. It comes in a variety of unique shapes and sizes. Each shape and size has its merits and benefits, depending on the learning situation. Tables can be combined with each other or with other tables combining a multitude of layouts creating an attractive look. Tables are made of Medium-density fiberboard (MDF) covered by high-pressure laminate (HPL). Legs are either fixed or adjustable to offer different heights, an advantage for mixed age groups.

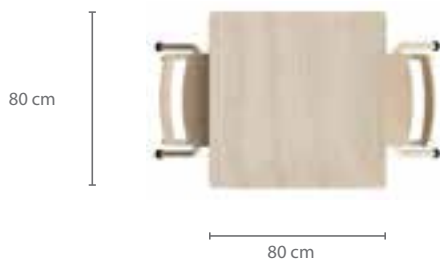

■ Flexo Table 80 x 80 cm



■ Flexo Table 120 x 80 cm

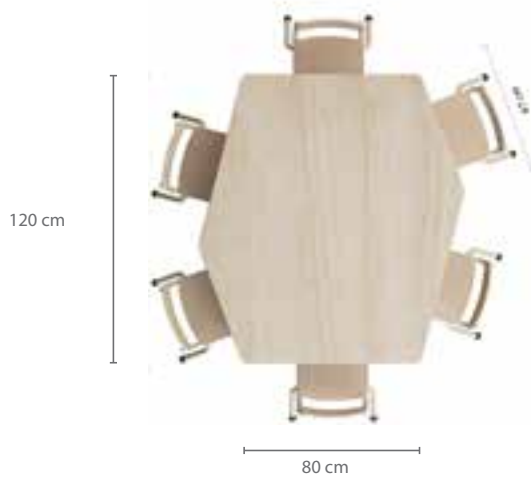

■ Flexo Table 120 x 80 cm

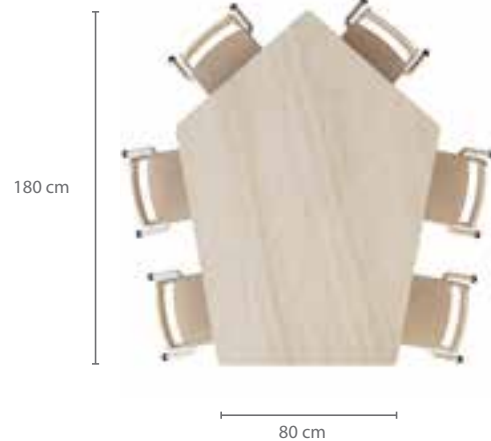

■ Flexo Table 180 x 80 cm

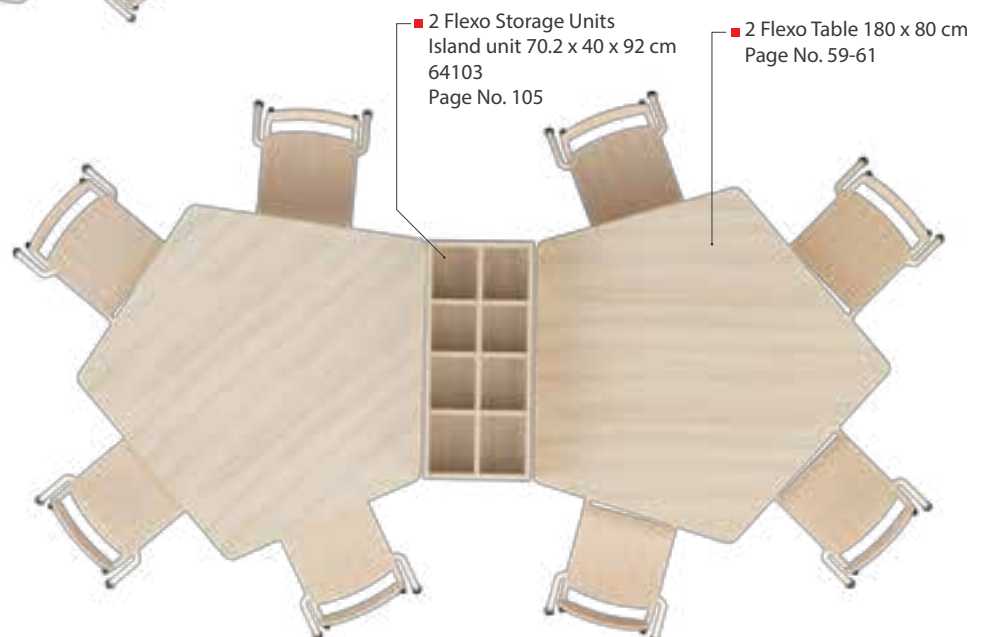
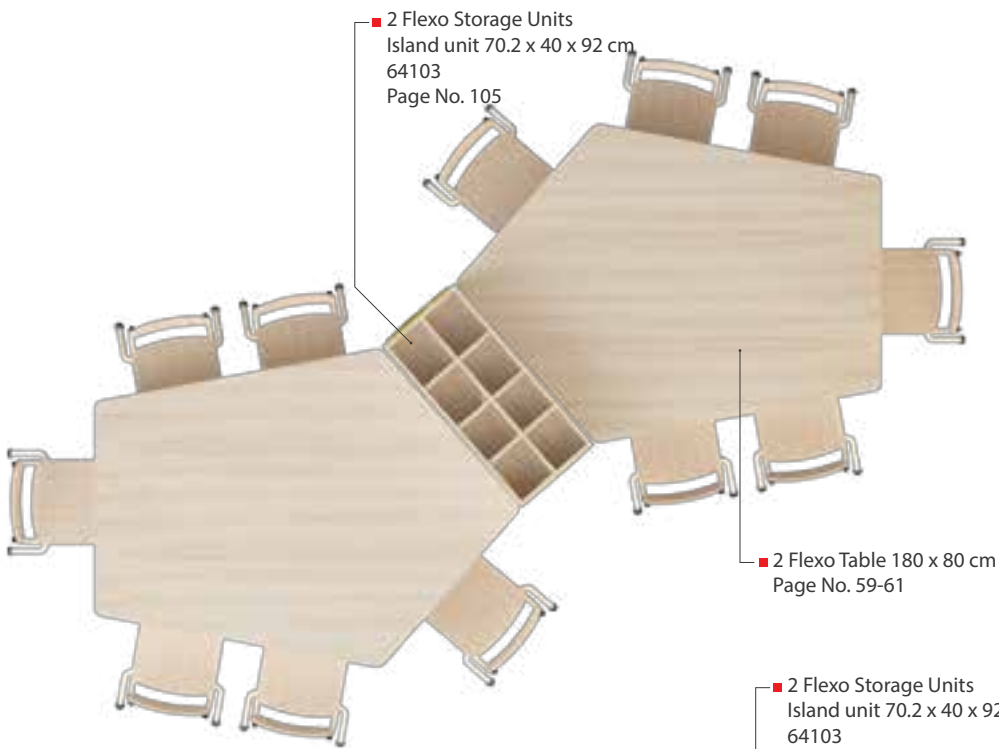
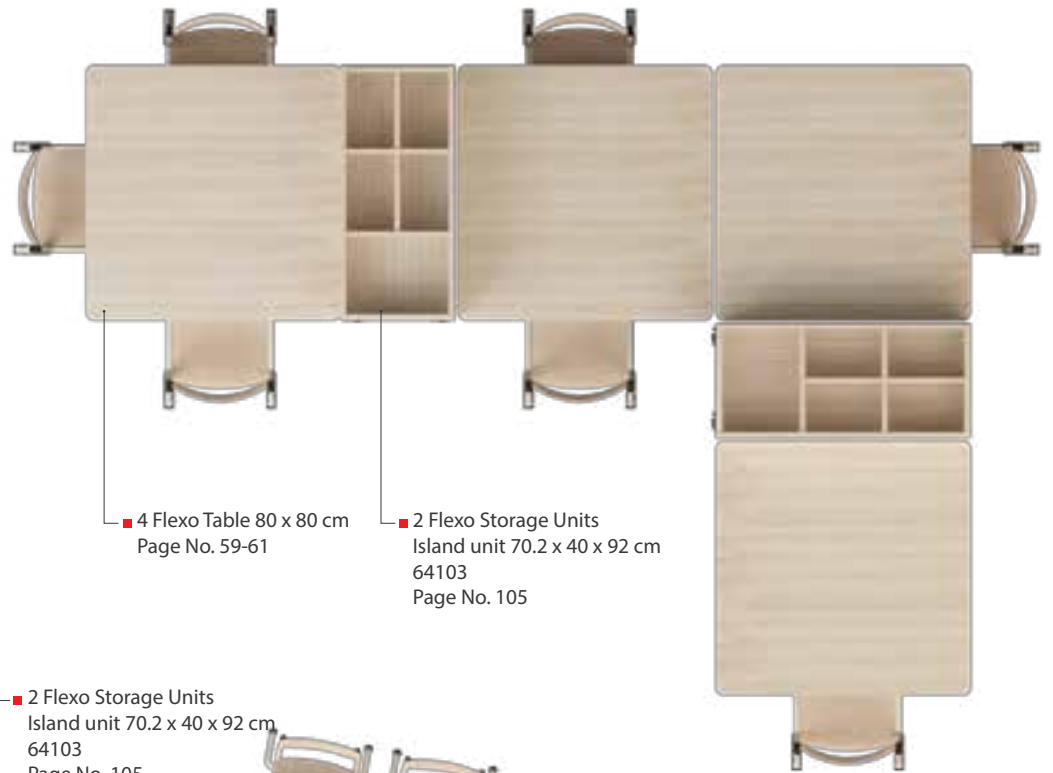

Flexo Tables



Table Top Option 1

28mm MDF Laminated HPL
solid beech edges

5 Chairs Flexo Table 120 x 120 cm	C0	44800	44803	C0	C0
	C1	44801	44804	C1	44701
	C2	44700	44805	C2	C2
	C3	44702	44806	C3	44808
	C4	44802	44807	C4	C4
7 Chairs Flexo Table 180 x 120 cm	C0	44810	44813	C0	C0
	C1	44811	44814	C1	44705
	C2	44704	44815	C2	C2
	C3	44706	44816	C3	44818
	C4	44812	44817	C4	C4
6 Chairs Flexo Table 120 x 120 cm	C0	44820	44823	C0	C0
	C1	44821	44824	C1	44709
	C2	44708	44825	C2	C2
	C3	44710	44826	C3	44828
	C4	44822	44827	C4	C4
4 Chairs Flexo Table 80 x 80 cm	C0	44830	44833	C0	C0
	C1	44831	44834	C1	44713
	C2	44712	44835	C2	C2
	C3	44714	44836	C3	44838
	C4	44832	44837	C4	C4

* Number of legs & Casters are upon table shape

Table - Top Colours	Wood Beige	Metal Leg Colours	Grey Beige
---------------------	---------------------	-------------------	---------------------



Adjustable Leg Heights

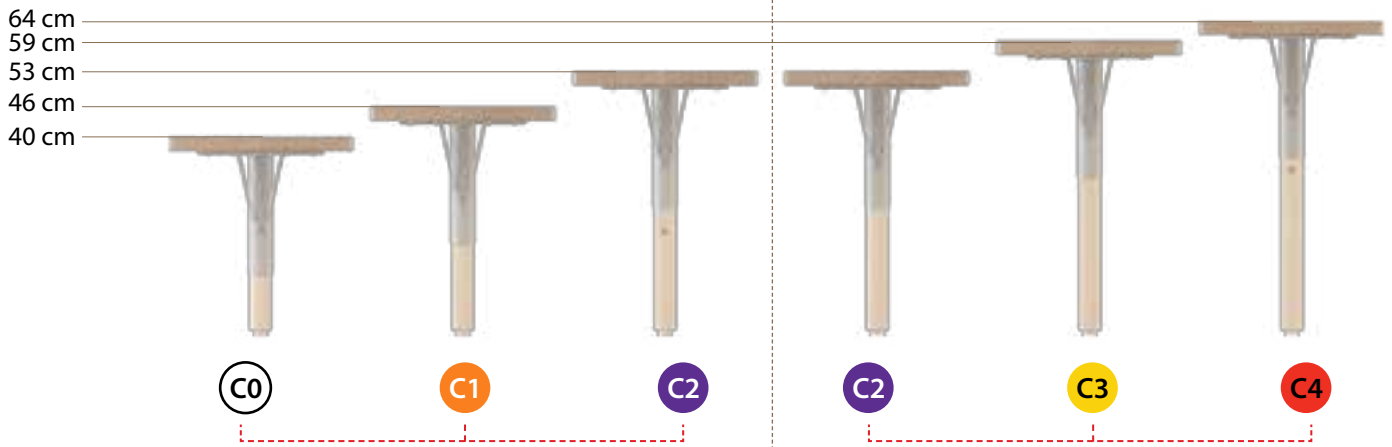

Available for Size **C0 to C4**

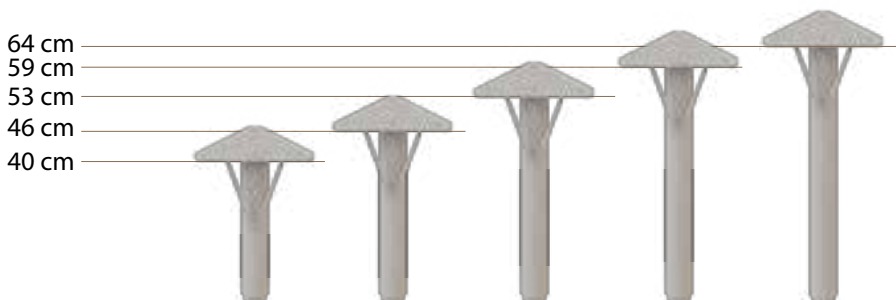

Flexo Tables



Table Top Option 2

28mm MDF Laminated HPL
Lacquer and varnish edges

Stages & Symbol	Table Top Option 2						
5 Chairs Flexo Table 120 x 120 cm	C0	47200	45574	C0	C0		
	C1	47201	45575	C1	47235	C1	47285
	C2	47202	45576	C2	47236	C2	47286
	C3	47203	45577	C3			
	C4	47204	45578	C4			
7 Chairs Flexo Table 180 x 120 cm	C0	47205	45579	C0	C0		
	C1	47206	45580	C1	47237	C1	47287
	C2	47207	45581	C2	47238	C2	47288
	C3	47208	45582	C3			
	C4	47209	45583	C4			
6 Chairs Flexo Table 120 x 120 cm	C0	47210	45584	C0	C0		
	C1	47211	45585	C1	47239	C1	47289
	C2	47212	45586	C2	47241	C2	47290
	C3	47213	45587	C3			
	C4	47214	45588	C4			
4 Chairs Flexo Table 80 x 80 cm	C0	47220	45594	C0	C0		
	C1	47221	45595	C1	47243	C1	47293
	C2	47222	45596	C2	47244	C2	47294
	C3	47223	45597	C3			
	C4	47224	45598	C4			

* Number of legs & Casters are upon table shape

Table - Top Colours	Wood Beige	Metal Leg Colours	Grey Beige
---------------------	---------------------	-------------------	---------------------



Adjustable Leg Heights

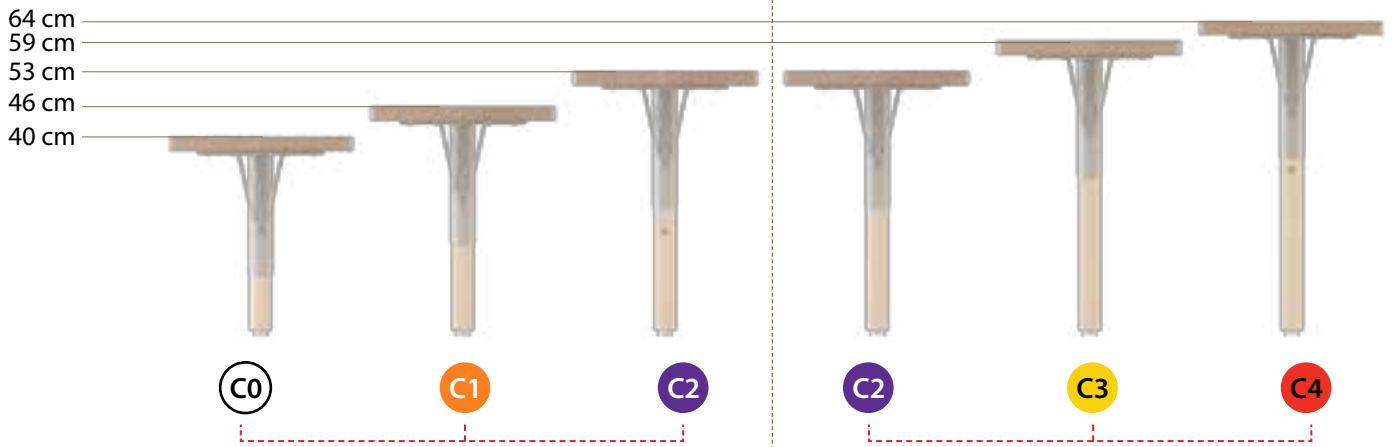

Available for Size **C0 to C4**

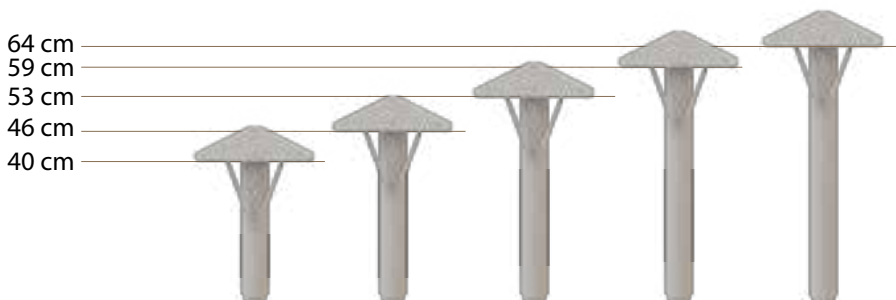

Multi Tables

These tables are the most versatile furnishings that are important for enhancing the learning environment for students. Tables come in a variety of unique shapes and sizes making them an ideal solution for student collaboration and interaction in today's multi-zone learning environments. This height adjustable table features a high-pressure laminate surface for long lasting use. It is made of Medium-density fiberboard (MDF) covered by high-pressure laminate (HPL). The tables' legs are either fixed or adjustable to offer different heights, which can be an advantage for mixed age groups.



ø 90 cm

■ Multi Table ø 90 cm



ø 90 cm

■ Multi Table ø 90 cm



95 cm

100 cm

■ Multi Table 100 x 95 cm



120 cm

120 cm

■ Multi Table 120 x 120 cm



80 cm

120 cm

■ Multi Table 120 x 80 cm



80 cm

120 cm

■ Multi Table 120 x 80 cm



60 cm

120 cm

■ Multi Table 120 x 60 cm



120 cm

180 cm

■ Multi Table 120 x 180 cm



78 cm

180 cm

■ Multi Table 180 x 78 cm



■ 2 Multi Table 120 x 120 cm
Page No. 65-68



■ 4 Multi Table 100 x 95 cm
Page No. 65-68



■ 5 Multi Table 100 x 95 cm
Page No. 65-68



■ 4 Multi Table 180 x 78 cm
Page No. 65-68



■ 2 Multi Table 120 x 80 cm
Page No. 65-68

Multi Tables











Table Top Option 1

28mm MDF Laminated HPL
solid beech edges

Stages & Symbol	C0 - Nursery1 40 cm
	C1 - Nursery2 46 cm
	C2 - K.G 1 53 cm
	C3 - K.G 2 59 cm
	C4 - Primary 64 cm



5 Multi Table 120x120 cm	C0	44890	44893	C0	44737	C0	44980
	C1	44891	44894	C1			
	C2	44736	44895	C2			
	C3	44738	44896	C3	44898	C3	44981
	C4	44892	44897	C4		C4	
4 Multi Table 120x80 cm	C0	44920	44923	C0	44749	C0	44982
	C1	44921	44924	C1			
	C2	44748	44925	C2			
	C3	44750	44926	C3	44928	C3	44983
	C4	44922	44927	C4		C4	
4 Multi Table ø90 cm	C0	44950	44953	C0	44761	C0	44984
	C1	44951	44954	C1			
	C2	44760	44955	C2			
	C3	44762	44956	C3	44958	C3	44985
	C4	44952	44957	C4		C4	
4 Multi Table 120x60 cm	C0	44880	44883	C0	44733	C0	44986
	C1	44881	44884	C1			
	C2	44732	44885	C2			
	C3	44734	44886	C3	44888	C3	44987
	C4	44882	44887	C4		C4	
5 Multi Table 120x80 cm	C0	44910	44913	C0	44745	C0	44988
	C1	44911	44914	C1			
	C2	44744	44915	C2			
	C3	44746	44916	C3	44918	C3	44989
	C4	44912	44917	C4		C4	

							
4  MultiTable ø90 cm	C0	44940	44943	C0	44757	C0	44990
	C1	44941	44944	C1			
	C2	44756	44945	C2			
	C3	44758	44946	C3	44948	C3	44991
	C4	44942	44947	C4		C4	
5  MultiTable 100x95 cm	C0	44870	44873	C0	44729	C0	44992
	C1	44771	44874	C1			
	C2	44728	44875	C2			
	C3	44730	44876	C3	44878	C3	44993
	C4	44872	44877	C4		C4	
5  MultiTable 180x78 cm	C0	44900	44903	C0	44741	C0	44994
	C1	44901	44904	C1			
	C2	44740	44905	C2			
	C3	44742	44906	C3	44908	C3	44995
	C4	44902	44907	C4		C4	
6  MultiTable 180x120 cm	C0	44930	44933	C0	44753	C0	44996
	C1	44931	44934	C1			
	C2	44752	44935	C2			
	C3	44754	44936	C3	44938	C3	44997
	C4	44932	44937	C4		C4	

* Number of legs & Casters are upon table shape

Table - Top Colours	 Wood	 Beige	Metal Leg Colours	 Grey	 Beige
---------------------	--	---	-------------------	--	---

Multi Tables



Table Top Option 2

28mm MDF Laminated HPL
Lacquer and varnish edges

5 Multi Table 120x120 cm	C0	47300	47350	C0		C0			
	C1	47301	47351	C1	47575	C1	47593		
	C2	47302	47352	C2		C2			
	C3	47303	47353	C3	47576	C3	47594		
	C4	47304	47354	C4		C4			
4 Multi Table 120x80 cm	C0	47305	47355	C0		C0			
	C1	47306	47356	C1	47577	C1	47595		
	C2	47307	47357	C2		C2			
	C3	47308	47358	C3	47578	C3	47596		
	C4	47309	47359	C4		C4			
4 Multi Table ø90 cm	C0	47310	47395	C0		C0			
	C1	47311	47361	C1	47579	C1	47597		
	C2	47312	47362	C2		C2			
	C3	47313	47363	C3	47580	C3	47598		
	C4	47314	47364	C4		C4			
4 Multi Table 120x60 cm	C0	47315	47365	C0		C0			
	C1	47316	47366	C1	47581	C1	47599		
	C2	47317	47367	C2		C2			
	C3	47318	47368	C3	47582	C3	47515		
	C4	47319	47369	C4		C4			
5 Multi Table 120x80 cm	C0	47320	47370	C0		C0			
	C1	47321	47371	C1	47583	C1	47516		
	C2	47322	47372	C2		C2			
	C3	47323	47373	C3	47584	C3	47517		
	C4	47334	47374	C4		C4			

4 Flexo Table ø 90 cm	C0	47325	47375	C0	47585	C0	47518
	C1	47326	47376	C1			
	C2	47327	47377	C2			
	C3	47328	47378	C3	47586	C3	47519
	C4	47329	47379	C4	C4	C4	
5 Multi Table 100x95 cm	C0	47330	47380	C0	47587	C0	47542
	C1	47331	47381	C1			
	C2	47332	47382	C2			
	C3	47333	47383	C3	47588	C3	47543
	C4	47334	47384	C4	C4	C4	
5 Multi Table 180x78 cm	C0	47335	47385	C0	47589	C0	47544
	C1	47336	47386	C1			
	C2	47337	47387	C2			
	C3	47338	47388	C3	47590	C3	47545
	C4	47339	47389	C4	C4	C4	
6 Multi Table 180x120 cm	C0	47340	47390	C0	47591	C0	47546
	C1	47341	47391	C1			
	C2	47342	47392	C2			
	C3	47343	47393	C3	47592	C3	47547
	C4	47344	47394	C4	C4	C4	

* Number of legs & Casters are upon table shape

Table - Top Colours			Metal Leg Colours		
	Wood	Beige		Grey	Beige

Curvy Tables

Well - designed Curvy tables can handle any activity and are a wide range of shapes. Curvy tables can accommodate a number of children. The leg's height can be adjusted with an easy turn of the screw.



■ Curvy Table 60 x 60 cm

■ Curvy Table 60 x 60 cm

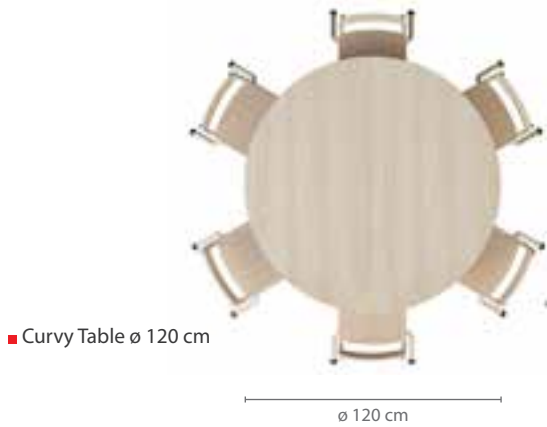

■ Curvy Table ø 120 cm

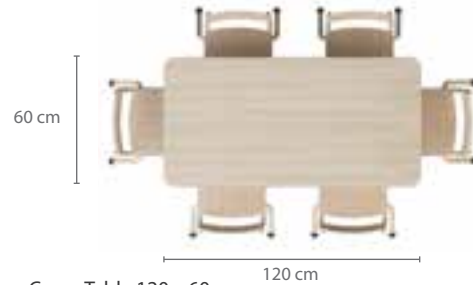

■ Curvy Table 120 x 60 cm



■ Curvy Table 120 x 60 cm



■ Curvy Table 180 x 100 cm

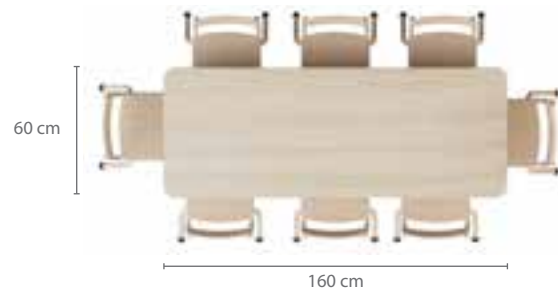

■ Curvy Table 160 x 60 cm



■ Curvy Table 180 x 120 cm



■ Curvy Table 160 x 60 cm



■ Curvy Table 120 x 76 cm



■ Curvy Table ø 120 cm

ø 120 cm



■ 3 Curvy Table 120 x 76 cm
Page No. 71-74



■ 2 Curvy Table 120 x 60 cm
1 Curvy Table 180 x 100 cm
Page No. 71-74



■ 4 Curvy Table 120 x 76 cm
Page No. 71-74

Curvy Tables













Table Top Option 1

28mm MDF Laminated HPL
solid beech edges

Stages & Symbol	C0 - Nursery1	40 cm
	C1 - Nursery2	46 cm
	C2 - K.G 1	53 cm
	C3 - K.G 2	59 cm
	C4 - Primary	64 cm



2 	C0	47000	47100	C0	47070	C0	47170
	C1	47001	47101	C1			
	C2	47002	47102	C2	47071	C2	47171
	C3	47003	47103	C3			
	C4	47004	47104	C4			
Curvy Table 60x60 cm							
6 	C0	47005	47105	C0	47072	C0	47172
	C1	47006	47106	C1			
	C2	47007	47107	C2			
	C3	47008	47108	C3	47073	C3	47173
	C4	47009	47109	C4			
Curvy Table 120x60 cm							
8 	C0	47010	47110	C0	47074	C0	47174
	C1	47011	47111	C1			
	C2	47012	47112	C2			
	C3	47013	47113	C3	47075	C3	47175
	C4	47014	47114	C4			
Curvy Table 160x60 cm							
2 	C0	47015	47115	C0	47076	C0	47176
	C1	47016	47116	C1			
	C2	47017	47117	C2			
	C3	47018	47118	C3	47077	C3	47177
	C4	47019	47119	C4			
Curvy Table 60x60 cm							
6 	C0	47020	47120	C0	47078	C0	47178
	C1	47021	47121	C1			
	C2	47022	47122	C2			
	C3	47023	47123	C3	47079	C3	47179
	C4	47024	47124	C4			
Curvy Table 120x60 cm							

							
8  Curvy Table 160x60 cm	C0	47025	47125	C0	47080	C0	47180
	C1	47026	47126	C1			
	C2	47027	47127	C2			
	C3	47028	47128	C3	47081	C3	47181
	C4	47029	47129	C4	C4	C4	
6  Curvy Table 180x100 cm	C0	47030	47130	C0	47082	C0	47182
	C1	47031	47131	C1			
	C2	47032	47132	C2			
	C3	47033	47133	C3	47083	C3	47183
	C4	47034	47134	C4	C4	C4	
6  Curvy Table 180x120 cm	C0	47035	47135	C0	47084	C0	47184
	C1	47036	47136	C1			
	C2	47037	47137	C2			
	C3	47038	47138	C3	47085	C3	47185
	C4	47039	47139	C4	C4	C4	
6  Curvy Table ø 120 cm	C0	47040	47140	C0	47086	C0	47186
	C1	47041	47141	C1			
	C2	47042	47142	C2			
	C3	47043	47143	C3	47087	C3	47187
	C4	47044	47144	C4	C4	C4	
4  Curvy Table 120x76 cm	C0	47045	47145	C0	47088	C0	47188
	C1	47046	47146	C1			
	C2	47047	47147	C2			
	C3	47048	47148	C3	47089	C3	47189
	C4	47049	47149	C4	C4	C4	
6  Curvy Table ø 120 cm	C0	47050	47150	C0	47090	C0	47190
	C1	47051	47151	C1			
	C2	47052	47152	C2			
	C3	47053	47153	C3	47091	C3	47191
	C4	47054	47154	C4	C4	C4	

* Number of legs & Casters are upon table shape

Table - Top Colours	 Wood	 Beige	Metal Leg Colours	 Grey	 Beige
---------------------	--	---	-------------------	--	---

Curvy Tables











Table Top Option 2

28mm MDF Laminated HPL
Lacquer and varnish edges

Stages & Symbol	C0 - Nursery1	40 cm
	C1 - Nursery2	46 cm
	C2 - K.G 1	53 cm
	C3 - K.G 2	59 cm
	C4 - Primary	64 cm



2 	C0	47400	47460	C0	47520	C0	47550
	C1	47401	47461	C1			
	C2	47402	47462	C2	47521	C2	47551
	C3	47403	47463	C3			
	C4	47404	47464	C4			
Curvy Table 60x60 cm							
6 	C0	47405	47465	C0	47522	C0	47552
	C1	47406	47466	C1			
	C2	47407	47467	C2	47523	C2	47553
	C3	47408	47468	C3			
	C4	47409	47469	C4			
Curvy Table 120x60 cm							
8 	C0	47410	47470	C0	47524	C0	47554
	C1	47411	47471	C1			
	C2	47412	47472	C2	47525	C2	47555
	C3	47413	47473	C3			
	C4	47414	47474	C4			
Curvy Table 160x60 cm							
2 	C0	47415	47475	C0	47526	C0	47556
	C1	47416	47476	C1			
	C2	47417	47477	C2	47527	C2	47557
	C3	47418	47478	C3			
	C4	47419	47479	C4			
Curvy Table 60x60 cm							
6 	C0	47420	47480	C0	47528	C0	47558
	C1	47421	47481	C1			
	C2	47422	47482	C2	47529	C2	47559
	C3	47423	47483	C3			
	C4	47424	47484	C4			
Curvy Table 120x60 cm							

							
8  Curvy Table 160x60 cm	C0	47425	47485	C0	47530	C0	47560
	C1	47426	47486	C1			
	C2	47427	47487	C2			
	C3	47428	47488	C3	47531	C3	47561
	C4	47429	47489	C4	C4	C4	
6  Curvy Table 180x100 cm	C0	47430	47490	C0	47532	C0	47562
	C1	47431	47491	C1			
	C2	47432	47492	C2			
	C3	47433	47493	C3	47533	C3	47563
	C4	47434	47494	C4	C4	C4	
6  Curvy Table 180x120 cm	C0	47435	47495	C0	47534	C0	47564
	C1	47436	47496	C1			
	C2	47437	47497	C2			
	C3	47438	47498	C3	47535	C3	47565
	C4	47439	47499	C4	C4	C4	
6  Curvy Table 120x60 cm	C0	47440	47500	C0	47536	C0	47566
	C1	47441	47501	C1			
	C2	47442	47502	C2			
	C3	47443	47503	C3	47537	C3	47567
	C4	47444	47504	C4	C4	C4	
4  Curvy Table 120x76 cm	C0	47445	47505	C0	47538	C0	47568
	C1	47446	47506	C1			
	C2	47447	47507	C2			
	C3	47448	47508	C3	47539	C3	47569
	C4	47449	47509	C4	C4	C4	
6  Curvy Table ø 120 cm	C0	47450	47510	C0	47540	C0	47570
	C1	47451	47511	C1			
	C2	47452	47512	C2			
	C3	47453	47513	C3	47541	C3	47571
	C4	47454	47514	C4	C4	C4	

* Number of legs & Casters are upon table shape

Table - Top Colours	 Wood	 Beige	Metal Leg Colours	 Grey	 Beige
---------------------	--	---	-------------------	--	---

Elegance Tables

Our lines of Elegance Tables come packed- flat for your convenience. The tables are easily assembled with the simple instructions provided. When correctly assembled, our tables are solid, stable and durable. Tables come in 3 convenient heights and 6 functional shapes. All our tables are modular and can be arranged in many different configurations. Legs and rails are made of either:

- Solid wood.

- Metal.

Plastic glides or coasters can be added upon your request.

All tables can be produced in two options of Table-tops as follows:

- Table top 22 mm made from extremely strong medium density fiberboard (MDF) laminated with high pressure laminate (HPL) . Edges made from solid beech wood with protective varnish .they are gently smoothed and lightly rounded to avoid any risk or injury.

- Table top 22 mm made from extremely strong medium density fiberboard (MDF) laminated with high pressure laminate (HPL) . Edges with protective varnish .they are gently smoothed and lightly rounded to avoid any risk or injury.

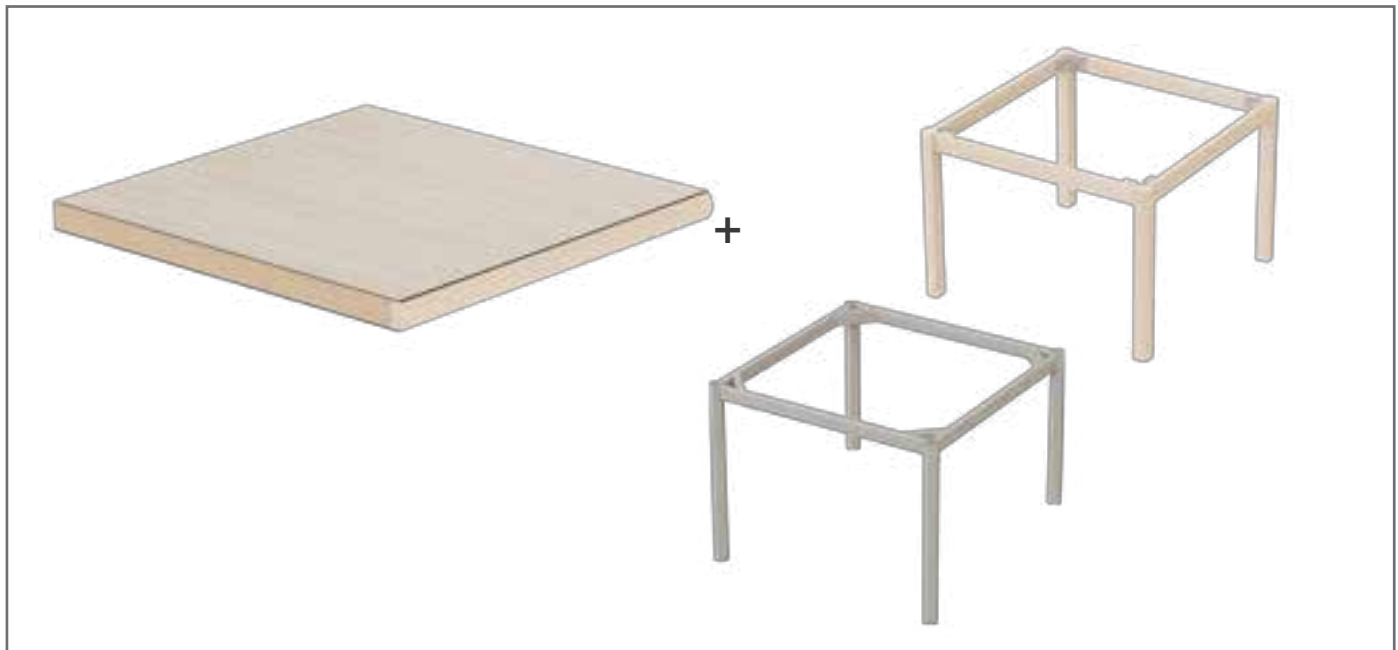

=



Wooden Legs / Rails

There are five different heights for these metal legs which is convenient to children different heights. These tables come packed- flat for your convenience. The tables are easily assembled with the simple instructions provided.



Rounded Edges



Plastic GLides



Connection

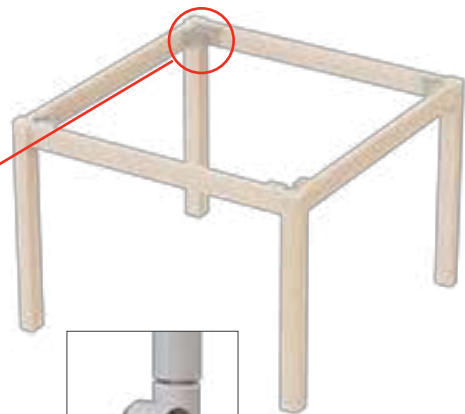

Available with or without Lockable Casters

64 cm
59 cm
53 cm
46 cm
40 cm

Table Heights

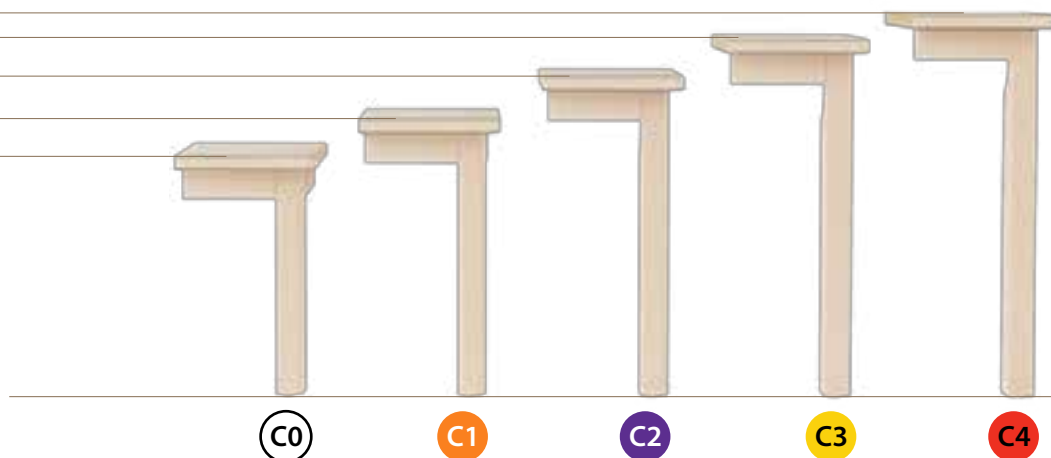

C0

C1

C2

C3

C4

Metal Legs / Rails

There are five different heights for these metal legs which is convenient to children different heights. These tables come packed- flat for your convenience. The tables are easily assembled with the simple instructions provided.

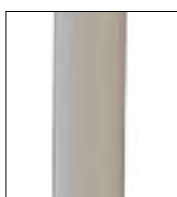

Electrostatic



Adjustable P.P glide



Available with or without Lockable Casters



Welded

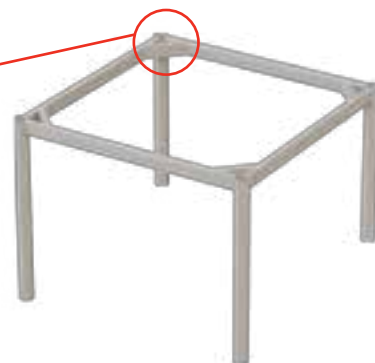

64 cm
59 cm
53 cm
46 cm
40 cm

Table Heights

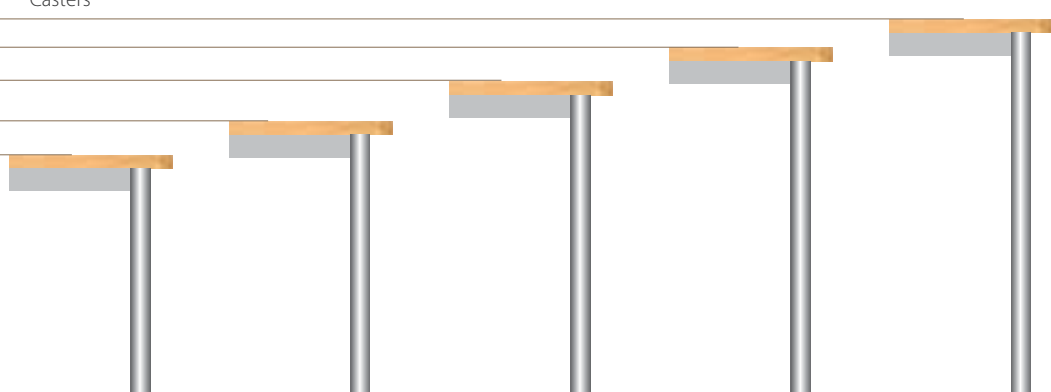

C0

C1

C2

C3

C4

Nursery 1

Nursery 2

K.G. 1

K.G. 2

Primary

Elegance Tables

Our lines of Elegance Tables come packed- flat for your convenience. The tables are easily assembled with the simple instructions provided. When correctly assembled, our tables are solid, stable and durable. Tables come in 3 convenient heights and 6 functional shapes. All our tables are modular and can be arranged in many different configurations. Legs and rails are made of either:

- Solid wood.
- Metal.

Plastic glides or coasters can be added upon your request.



ø 120 cm

■ Elegance Table ø 120 cm

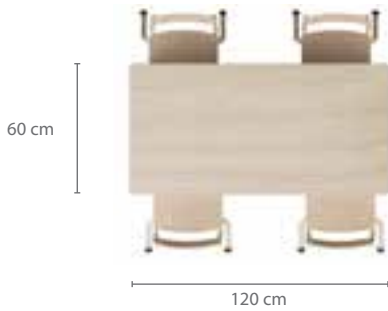

60 cm

120 cm

■ Elegance Table 120 x 60 cm



ø 90 cm

■ Elegance Table ø 120 cm



ø 120 cm

■ Elegance Table ø 120 cm

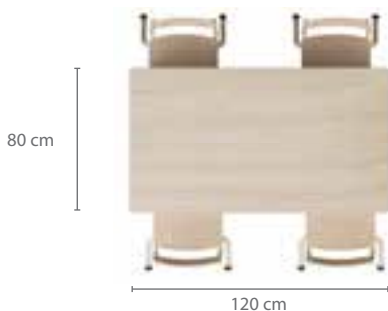

80 cm

120 cm

■ Elegance Table 120 x 80 cm



52 cm

120 cm

■ Elegance Table 120 x 52 cm



120 cm

180 cm

■ Elegance Table 180 x 120 cm



60 cm

80 cm

■ Elegance Table 80 x 60 cm



60 cm

60 cm

■ Elegance Table 60 x 60 cm



60 cm

120 cm

■ Elegance Table 120 x 60 cm



60 cm

120 cm

■ Elegance Table 120 x 60 cm

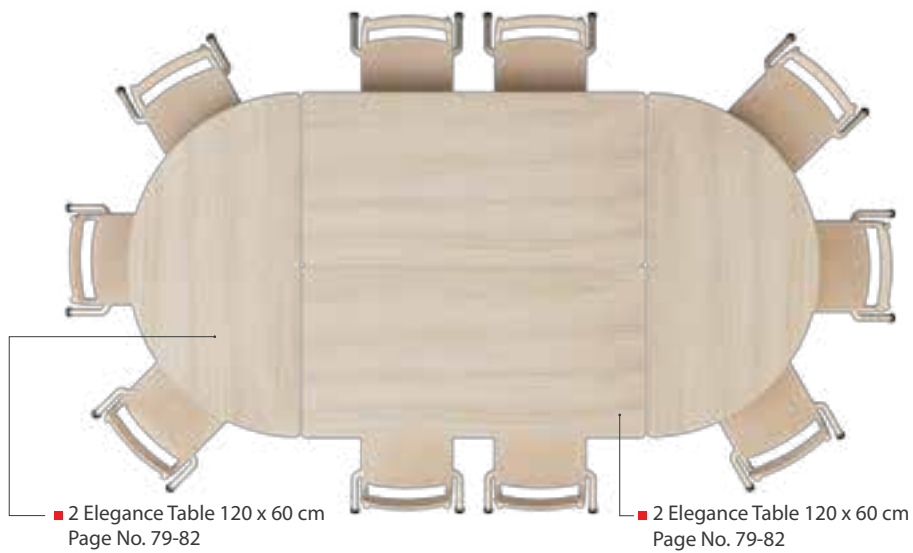
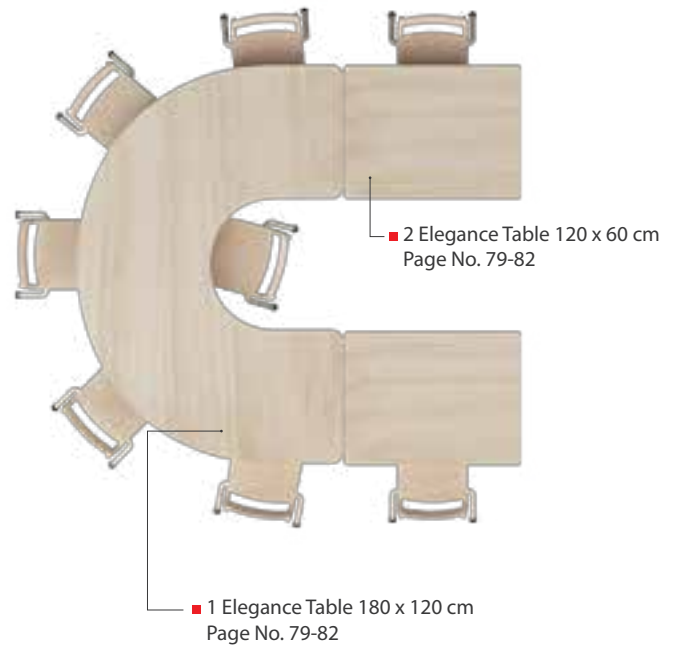
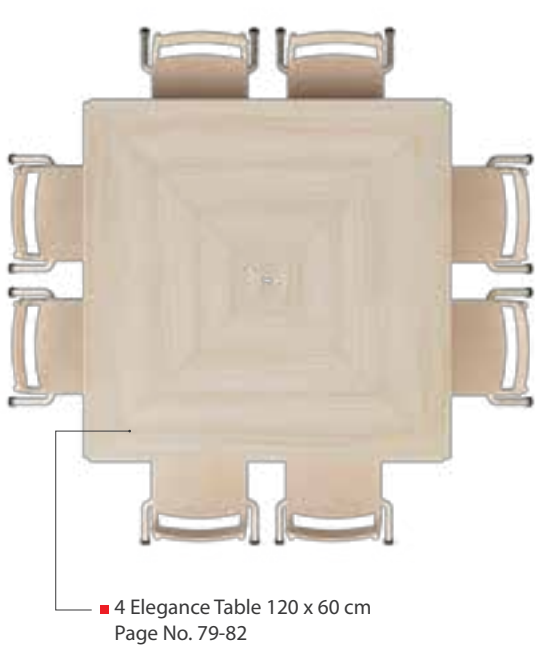
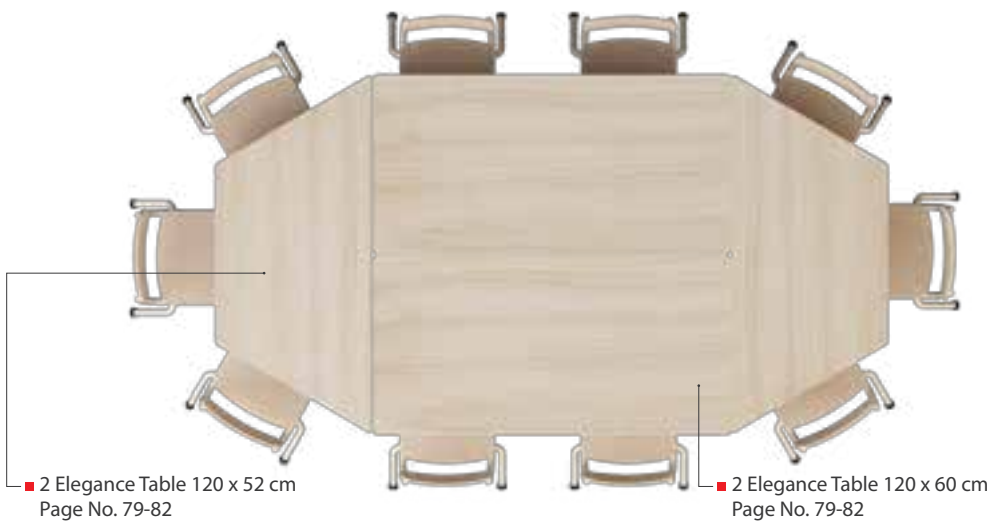

Elegance Tables



Table Top Option 1

28mm MDF Laminated HPL
solid beech edges

Stages & Symbol	C0 - Nursery1	40 cm
	C1 - Nursery2	46 cm
	C2 - K.G 1	53 cm
	C3 - K.G 2	59 cm
	C4 - Primary	64 cm



4 Elegance Table 60x80 cm	C0	44321	47860	47920	47950
	C1	44322	47861	47921	47951
	C2	44323	47862	47922	47952
	C3	44324	47863	47923	47953
	C4	44325	47864	47924	47954
6 Elegance Table 120x60 cm	C0	44331	47865	44530	44531
	C1	44332	47866	44532	44533
	C2	44333	47867	44621	44640
	C3	44334	47868	44626	44645
	C4	44335	47869	44534	44535
4 Elegance Table 120x60 cm	C0	44511	47870	44536	44537
	C1	44512	47871	44538	44539
	C2	44513	47872	44624	44642
	C3	44514	47873	44629	44647
	C4	44516	47874	44540	44541
4 Elegance Table ø 120 cm	C0	44410	47875	44542	44543
	C1	44411	47876	44544	44545
	C2	44412	47877	44625	44643
	C3	44413	47878	44630	44648
	C4	44408	47879	44546	44547
2 Elegance Table ø 90 cm	C0	44415	47880	47926	47955
	C1	44416	47881	47927	47956
	C2	44417	47882	47928	47957
	C3	44418	47883	47929	47958
	C4	44419	47884	47930	47959













					
3  Elegance Table 120x52 cm	C0	44201	47885	44548	44549
	C1	44202	47886	44550	44551
	C2	44203	47887	44623	44641
	C3	44204	47888	44628	44646
	C4	44205	47889	44552	44553
8  Elegance Table ø 120 cm	C0	44685	47890	47931	47960
	C1	44686	47891	47932	47961
	C2	44687	47892	47933	47962
	C3	44688	47893	47934	47963
	C4	44689	47894	47935	47964
4  Elegance Table 120x60 cm	C0	44675	47895	44560	44561
	C1	44676	47896	44562	44563
	C2	44677	47897	44631	44635
	C3	44678	47898	44632	44636
	C4	44679	47899	44564	44565
6  Elegance Table 180x120 cm	C0	44670	47900	47936	47965
	C1	44671	47901	47937	47966
	C2	44672	47902	47938	47967
	C3	44673	47903	47939	47968
	C4	44674	47904	47940	47969
6  Elegance Table 120x80 cm	C0	44680	47905	44554	44555
	C1	44681	47906	44556	44557
	C2	44682	47907	44622	44644
	C3	44683	47908	44627	44649
	C4	44684	47909	44558	44559
2  Elegance Table 60x60 cm	C0	44690	47910	44611	44616
	C1	44691	47911	44612	44617
	C2	44692	47912	44613	44618
	C3	44693	47913	44614	44619
	C4	44694	47914	44615	44620

Table - Top Colours	 Wood	 Beige
---------------------	--	---

Elegance Tables



Table Top Option 2

28mm MDF Laminated HPL
Lacquer and varnish edges

Stages & Symbol	C0 - Nursery1	40 cm
	C1 - Nursery2	46 cm
	C2 - K.G 1	53 cm
	C3 - K.G 2	59 cm
	C4 - Primary	64 cm



4 Elegance Table 60x80 cm	C0	47600	47660	47720	47800
	C1	47601	47661	47721	47801
	C2	47602	47662	47722	47802
	C3	47603	47663	47723	47803
	C4	47604	47664	47724	47804
6 Elegance Table 120x60 cm	C0	47605	47665	47725	47805
	C1	47606	47666	47726	47806
	C2	47607	47667	47727	47807
	C3	47608	47668	47728	47808
	C4	47609	47669	47729	47809
4 Elegance Table 120x60 cm	C0	47610	47670	47730	47810
	C1	47611	47671	47731	47811
	C2	47612	47672	47732	47812
	C3	47613	47673	47733	47813
	C4	47614	47674	47734	47814
4 Elegance Table ø 120 cm	C0	47615	47675	47735	47815
	C1	47616	47676	47736	47816
	C2	47617	47677	47737	47817
	C3	47618	47678	47738	47818
	C4	47619	47679	47739	47819
2 Elegance Table ø 90 cm	C0	47620	47680	47740	47820
	C1	47621	47681	47741	47821
	C2	47622	47682	47742	47822
	C3	47623	47683	47743	47823
	C4	47624	47684	47744	47824











					
3  Elegance Table 120x52 cm	C0	47625	47685	47745	47825
	C1	47626	47686	47746	47826
	C2	47627	47687	47747	47827
	C3	47628	47688	47748	47828
	C4	47629	47689	47749	47829
8  Elegance Table ø 120 cm	C0	47630	47690	47750	47830
	C1	47631	47691	47751	47831
	C2	47632	47692	47752	47832
	C3	47633	47693	47753	47833
	C4	47634	47694	47754	47834
4  Elegance Table 120x60 cm	C0	47635	47695	47755	47835
	C1	47636	47696	47756	47836
	C2	47637	47697	47757	47837
	C3	47638	47698	47758	47838
	C4	47639	47699	47759	47839
6  Elegance Table 180x120 cm	C0	47640	47700	47760	47840
	C1	47641	47701	47761	47841
	C2	47642	47702	47762	47842
	C3	47643	47703	47763	47843
	C4	47644	47704	47764	47844
6  Elegance Table 120x80 cm	C0	47645	47705	47765	47845
	C1	47646	47706	47766	47846
	C2	47647	47707	47767	47847
	C3	47648	47708	47768	47848
	C4	47649	47709	47769	47849
2  Elegance Table 60x60 cm	C0	47650	47710	47770	47850
	C1	47651	47711	47771	47851
	C2	47652	47712	47772	47852
	C3	47653	47713	47773	47853
	C4	47654	47714	47774	47854

Table - Top Colours	 Wood	 Beige
---------------------	--	---

Chairs

Tables



Little children are not always taken into consideration when it comes to educational furniture. That is why we designed special sizes for them. Toddlers should always use the appropriate size of chairs or table to ensure good posture and prevent causing problems or distortions for them while growing. Ergonomic seating requires adjustable furniture to suits different body heights.

Children`s ages	0 - 2		2 - 3	2 - 4	4 - 6	6 - 8	8 - 11
Chairs & Tables Symbol	C 01	C 02	C 0	C 1	C 2	C 3	C 4
Chairs seat height	13 cm	17 cm	21 cm	26 cm	31 cm	35 cm	38 cm
Tables height - Fixed legs	30 cm	36 cm	40 cm	46 cm	53 cm	59 cm	64 cm
Tables height - Adjustable legs							
Toddler Chairs & Tables							





Elegance Toddler Chair

This beautifully crafted armed chair would look great in any nursery or day care centres. Special size is made specifically for little ones to give them comfort and good support .It is made of solid, top-quality lacquered beech wood and is built to last.

CO 27.5 x 23 cm - H.21 cm
43206



Deluxe Toddler Chair

A natural armed chair that will last for generations. The ergonomically curved seat and backrest provide the most comfortable seating for little children. It's special size is made specifically for toddlers. It is made of solid, top-quality lacquered beech wood & plywood.

CO 27.5 x 25 cm - H.21 cm
43265





Captain Toddler Chair

A classic style seating made from high quality solid beech wood with a recessed wooden seat base and a wrap-around seat back, providing back and side support for children. Suitable for growing toddlers who are starting to become more independent but still providing much needed security. Durable varnish in natural polished finish, robustly constructed for heavy usage and long lasting.



Metal bracket & solid massive beech leg



CO1 45 x 40 cm - H. 13 cm
43513



CO2 45 x 40 cm - H. 17 cm
43514



CO 45 x 40 cm - H. 21 cm
43515

Kinder Chairs & Benches

This ergonomic wooden chairs & bench are a great addition to your classroom or day care centers. It is made of solid, top-quality lacquered beech wood & plywood. Benches can be nested together to save space.



- C01 43241 70 x 40 cm - H. 13 cm
- C02 43242 70 x 40 cm - H. 17 cm
- C0 43240 70 x 40 cm - H. 21 cm

- C01 43236 36 x 40 cm - H. 13 cm
- C02 43237 36 x 40 cm - H. 17 cm
- C0 43235 36 x 40 cm - H. 21 cm

Flip around Chair

This infant to toddler-sized chair is perfect for small children. The chair is light and children can turn it over alone. The seat height is different when you turn it over, or can be turned to a table. Oval holes on its sides facilitate handling. Chairs are made from laminated plywood. Benches are also available.

Chair	43340	30 x 32 cm - H.31 cm
Bench	43345	67 x 30 cm - H.31 cm



Bench



Chair 30 x 32 cm



Chair 30 x 26 cm



Table 30 x 30 cm



Wood/Metal legs

These legs can be adjusted according to children different heights. There are two legs you can choose from. The first leg can be used from (C0 – C2) stage and the second leg can be used from (C2- C4) stage. It is ideal for mixed age classrooms.



Wooden Legs / Rails

There are five different heights for these metal legs which is convenient to children different heights. These tables come packed- flat for your convenience. The tables are easily assembled with the simple instructions provided.

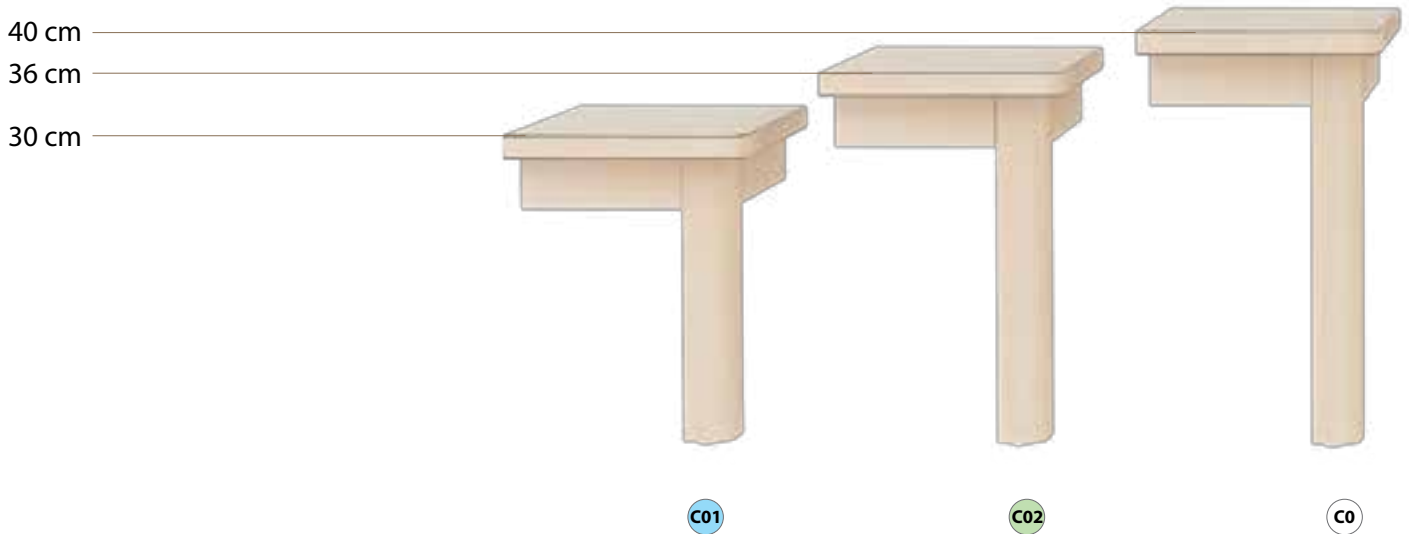



28mm MDF Laminated HPL solid beech edges

Table -Top Option (1)

Table top 28mm thickness made from extremely strong medium density fiberboard (MDF) insulation , stiff , has no knots , will produce fine and better edges and tops laminated with high pressure laminated HPL (under heat (90-80 Celsius) and pressure (250 kgs/m2) - (NAF) no added formaldehyde, (Beige color or sand ash wood theme)

Edges made from solid beech wood painted with protective varnish, gently and safety rounded edges



28mm MDF Laminated HPL Lacquer and varnish edges

Table -Top Option (2)

Table top 28mm thickness made from extremely strong medium density fiberboard (MDF) insulation , stiff , has no knots , will produce fine and better edges and tops laminated with high pressure laminated HPL under heat (90-80 Celsius) and pressure (250 kgs/m2) - (NAF) no added formaldehyde, (Beige color or sand ash wood theme).

Edges painted with protective lacquer and varnish, gently smoothed and safety rounded edges



28mm Massive solid beech wood and varnish edges

Table -Top Option (3)

Table top 28mm thickness made from massive solid Beech wood (KD) – traditional wooden joints, using high quality European standard adhesive , (NAF) no added formaldehyde, The Top and Edges painted with protective lacquer and varnish, gently and safety rounded edges

Elegance Toddler Tables

Our lines of Elegance Tables come packed- flat for your convenience. The tables are easily assembled with the simple instructions provided. When correctly assembled, our tables are solid, stable and durable. Tables come in 3 convenient heights and 6 functional shapes. All our tables are modular and can be arranged in many different configurations. Legs and rails are made of solid wood.

All tables can be produced in three options of Table-tops as follows:

- Table top 28mm made from extremely strong medium density fiberboard (MDF) laminated with high pressure laminate (HPL) . Edges made from solid beech wood with protective varnish .they are gently smoothed and lightly rounded to avoid any risk or injury.

- Table top 28mm made from extremely strong medium density fiberboard (MDF) laminated with high pressure laminate (HPL) . Edges with protective varnish .they are gently smoothed and lightly rounded to avoid any risk or injury.

- Table top 28mm thickness made from massive solid Beech wood (KD) – traditional wood joints, using high quality European standard adhesive , (NAF) no added formaldehyde, The Top and Edges painted with protective lacquer and varnish, gently and safety round edges

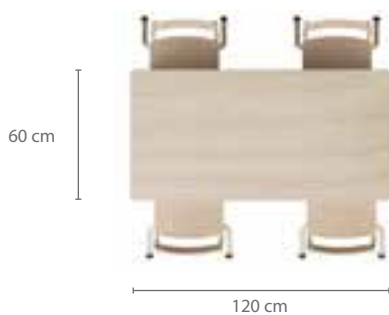

■ Elegance Table 120 x 60 cm



■ Elegance Table ø 120 cm



■ Elegance Table 120 x 52 cm



■ Elegance Table 180 x 120 cm



■ Elegance Table 80 x 60 cm



■ Elegance Table 60 x 60 cm

Stages & Symbol C01 - Toddler1 30 cm C02 - Toddler2 36 cm C0 - Nursery1 40 cm		 Table Top Option 1 28mm MDF Laminated HPL solid beech edges	 Table Top Option 2 28mm MDF Laminated HPL Lacquer and varnish edges
 Elegance Table 52 x 120 cm	C 01	48020	48032
	C 02	48021	48033
	C 0	44201	47625
 Elegance Table 60 x 80 cm	C 01	48022	48034
	C 02	48023	48035
	C 0	44321	47600
 Elegance Table 60 x 120 cm	C 01	48024	48036
	C 02	48025	48037
	C 0	44331	47605
 Elegance Table 120 x 180 cm	C 01	48026	48038
	C 02	48027	48039
	C 0	44670	47640
 Elegance Table ø 120 cm	C 01	48028	48040
	C 02	48029	48041
	C 0	44410	47615
 Elegance Table 60 x 60 cm	C 01	48030	48042
	C 02	48031	48043
	C 0	44690	47654

* Number of legs & Casters are upon table shape

Table - Top Colours	 Wood	 Beige
---------------------	--	---

Flexo Toddler Tables

These flexible movable creative tables combine natural looks, functionality as well as flexibility and encourage social behaviour, creativity and cooperation among little children. It comes in a variety of unique shapes and sizes. Each shape and size has its merits and benefits, depending on the learning situation. Tables can be combined with each other or with other tables combining a multitude of layouts creating an attractive look.

All tables can be produced in three options of Table-tops as follows:

- Table top 28mm made from extremely strong medium density fiberboard (MDF) laminated with high pressure laminate (HPL) . Edges made from solid beech wood with protective varnish .they are gently smoothed and lightly rounded to avoid any risk or injury.

- Table top 28mm made from extremely strong medium density fiberboard (MDF) laminated with high pressure laminate (HPL) . Edges with protective varnish .they are gently smoothed and lightly rounded to avoid any risk or injury.

- Table top 28mm thickness made from massive solid Beech wood (KD) – traditional wooden joints, using high quality European standard adhesive , (NAF) no added formaldehyde,
The Top and Edges painted with protective lacquer and varnish, gently and safety rounded edges

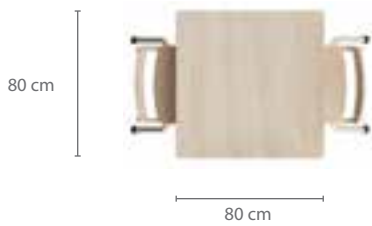

■ Flexo Table 80 x 80 cm





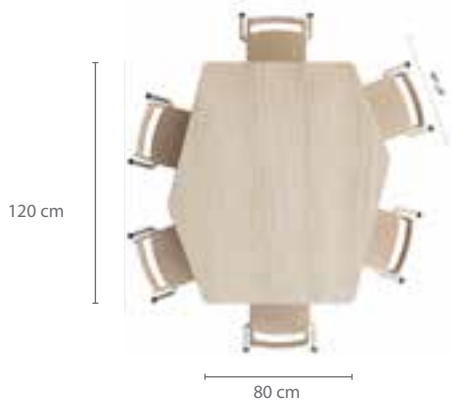

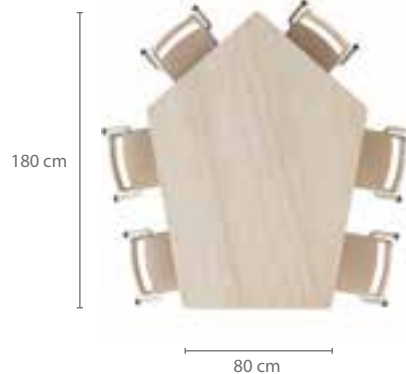

■ Flexo Table 120 x 80 cm





■ Flexo Table 120 x 80 cm



■ Flexo Table 180 x 80 cm

		 Table Top Option 1 28mm MDF Laminated HPL solid beech edges	 Table Top Option 2 28mm MDF Laminated HPL Lacquer and varnish edges
 Flexo Table 80 x 120 cm	C 01 C 02 C 0	47970	47976
 Flexo Table 80 x 180 cm	C 01 C 02 C 0	47972	47978
 Flexo Table 120 x 80 cm	C 01 C 02 C 0	47973	47979
 Flexo Table 80 x 80 cm	C 01 C 02 C 0	47975	47981

* Number of legs & Casters are upon table shape

Table - Top Colours	 Wood  Beige	Metal Leg Colours	 Grey  Beige
---------------------	--	-------------------	--

Curvy Toddler Tables

All tables can be produced in three options of Table-tops as follows:

- Table top 28mm made from extremely strong medium density fiberboard (MDF) laminated with high pressure laminate (HPL) . Edges made from solid beech wood with protective varnish .they are gently smoothed and lightly rounded to avoid any risk or injury.

- Table top 28mm made from extremely strong medium density fiberboard (MDF) laminated with high pressure laminate (HPL) . Edges with protective varnish .they are gently smoothed and lightly rounded to avoid any risk or injury.

- Table top 28mm thickness made from massive solid Beech wood (KD) – traditional wooden joints, using high quality European standard adhesive , (NAF) no added formaldehyde,

The Top and Edges painted with protective lacquer and varnish, gently and safety rounded edges



ø 120 cm

■ Curvy Table ø 120 cm

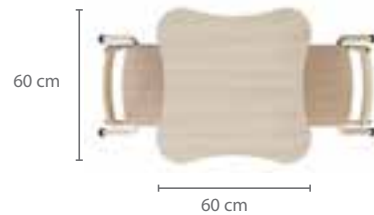

60 cm

60 cm

■ Curvy Table 60 x 60 cm



80 cm

180 cm

■ Curvy Table 180 x 80 cm

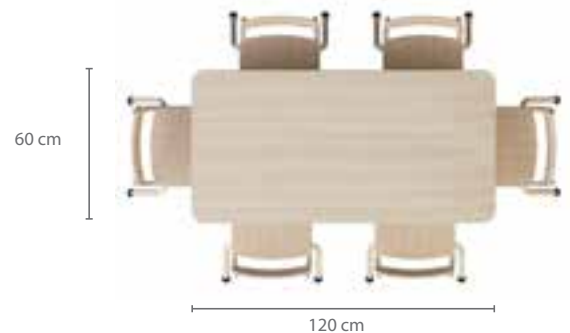

60 cm

120 cm

■ Curvy Table 120 x 60 cm



60 cm

100 cm

■ Curvy Table 100 x 60 cm



60 cm

120 cm

■ Curvy Table 120 x 60 cm

		 Table Top Option 1 28mm MDF Laminated HPL solid beech edges	 Table Top Option 2 28mm MDF Laminated HPL Lacquer and varnish edges
 Curvy Table 120x60 cm	C 01	48000	48006
	C 02		
	C 0		
 Curvy Table ø 120 cm	C 01	48001	48007
	C 02		
	C 0		
 Curvy Table 120x80 cm	C 01	48002	48008
	C 02		
	C 0		
 Curvy Table 120x80 cm	C 01	48003	48009
	C 02		
	C 0		
 Curvy Table 120x80 cm	C 01	48004	48010
	C 02		
	C 0		
 Curvy Table 60x100 cm	C 01	48005	48011
	C 02		
	C 0		

* Number of legs & Casters are upon table shape

Table - Top Colours	 Wood  Beige	Metal Leg Colours	 Grey  Beige
---------------------	--	-------------------	--

Kinder Tables

Robust solid tables that will last for generations. Kinder Tables come packed- flat for your convenience and they are easily assembled with the simple instructions provided. Tables come in 3 convenient heights and 4 functional shapes. Legs and rails are made of solid wood. Ideal for little children from one to three years.

All tables can be produced in three options of Table-tops as follows:

- Table top 28mm made from extremely strong medium density fiberboard (MDF) laminated with high pressure laminate (HPL) . Edges made from solid beech wood with protective varnish .they are gently smoothed and lightly rounded to avoid any risk or injury.

- Table top 28mm made from extremely strong medium density fiberboard (MDF) laminated with high pressure laminate (HPL) . Edges with protective varnish .they are gently smoothed and lightly rounded to avoid any risk or injury.

- Table top 28mm thickness made from massive solid Beech wood (KD) – traditional wooden joints, using high quality European standard adhesive , (NAF) no added formaldehyde, The Top and Edges painted with protective lacquer and varnish, gently and safety rounded edges

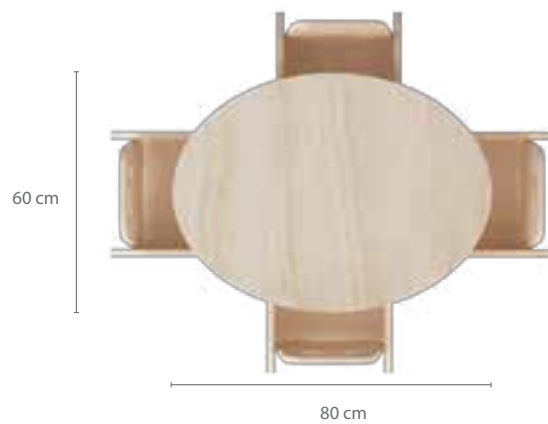
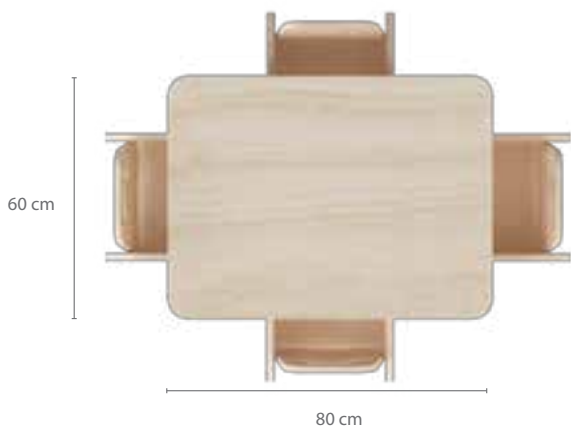









				
		Table Top Option 1 28mm MDF Laminated HPL solid beech edges	Table Top Option 2 28mm MDF Laminated HPL Lacquer and varnish edges	Table Top Option 3 28mm Massive solid beech wood and varnish edges
 kinderTable 80x60 cm	C 01	48063	48066	48069
	C 02	48064	48067	48070
	C 0	48065	48068	48071
 kinderTable 60x60 cm	C 01	48072	48075	48078
	C 02	48073	48076	48079
	C 0	48074	48077	47080
 kinderTable ø 60 cm	C 01	48081	48084	48087
	C 02	48082	48085	48088
	C 0	48083	48086	48089
 kinderTable 80x60 cm	C 01	48090	48093	48096
	C 02	48091	48094	48097
	C 0	48092	48095	48098

Table - Top Colours	 Wood	 Beige
---------------------	--	---

Storage Units





Flexo Storage Units

Our perfectly flexible storage units offer a variety of options and arrangements. All units are 40 cm deep to link them together and create a multitude of layouts with different heights. They are designed empty to complete with storage plastic trays (with anti-fall safety runners). The shelves are extremely resistant and designed to support the weight of heavy books and objects. Made of Medium-density fiberboard (MDF) and melamine coated on both sides and doors, with PVC edge banding. Available in single, double, triple and quadruple units they can be assembled upon request.



With Metal base
Height metal base + 12 cm

99698



Heavy-duty lockable casters



Wide range of height & width



W/o casters H. 40 cm
With casters H. 52 cm



H. 60 cm
H. 72 cm



H. 80 cm
H. 92 cm



W. 36.2 cm



W. 70.2 cm



W. 103.6 cm



W. 138 cm



Trays Supplier



Made in UK

W 35.9 x D 40 x H 40 cm

W/ Castors W 35.9 x D 40 x H 53.2 cm

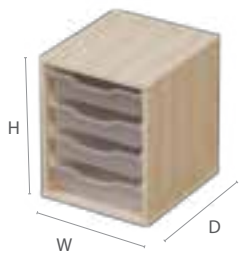

64003



64203

W 69.7 x D 40 x H 40 cm

W/ Castors W 69.7 x D 40 x H 53.2 cm



64004



64204



64005



64205



64007



64207

W 103.6 x D 40 x H 40 cm

W/ Castors W 35.5 x D 40 x H 53.2 cm



64002



64202



64012



64212

W 138 x D 40 x H 40 cm

W/ Castors W 35.5 x D 40 x H 53.2 cm

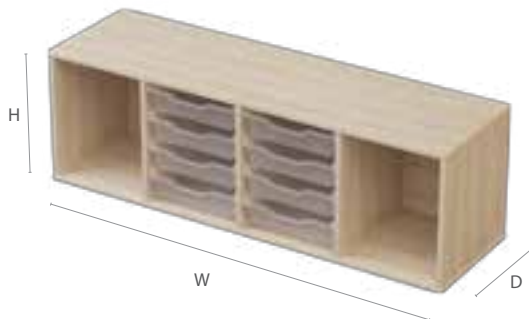

64111



64211

W 35.9 x D 40 x H 60 cm

W/ Castors W 35.5 x D 40 x H 73.5 cm



64021



64221

W 69.7 x D 40 x H 60 cm

W/ Castors W 69.7 x D 40 x H 53.2 cm

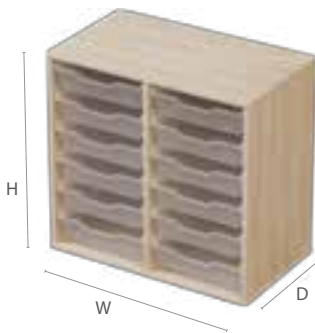

64026



64226



Island unit 70.2 x 40 x 92 cm 64104



64035



64235



Island unit 70.2 x 40 x 92 cm 64103



64037



64237



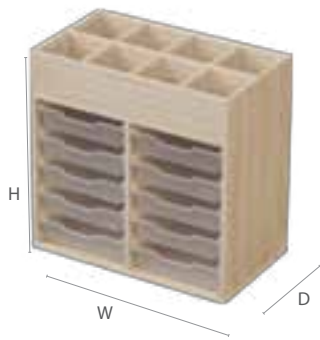

64038



64238

W 103.6 x D 40 x H 60 cm

W/ Castors W 35.5 x D 40 x H 73.5 cm



64027



64227



64036



64236

W 138 x D 40 x H 60 cm

W/ Castors W 138 x D 40 x H 73.5 cm



64110



64210

W 35.9 x D 40 x H 80 cm

W/ Castors W 35.5 x D 40 x H 93.5 cm



64042



64242

W 69.7 x D 40 x H 80 cm

W/ Castors W 69.7 x D 40 x H 93.5 cm

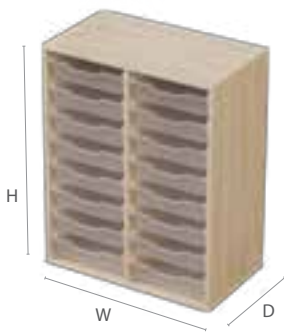

64115



64215



Island unit 103.6 x 40 x 92 cm 64102



64116



64216



64055



64255

W 103.6 x D 40 x H 80 cm

W/ Castors W 35.5 x D 40 x H 93.5 cm



64054



64254



64117



64217

W 138 x D 40 x H 80 cm

W/ Castors W 35.5 x D 40 x H 93.5 cm



64118



64218



64051



64251

Ultimate N Storage Units

As well as looking attractive, this series of tray storage units are flexible and versatile. This collection was designed to fulfill the storage needs of any learning environment like KG Classrooms and art classrooms. The transparent trays & natural shelves give you the ability to make simple layouts with neutral design.





Curvy edges for more safety



Solid beech Profile



Heavy-duty lockable casters

Trays Supplier



Made in UK

W 35.5 x D 45 x H 61 cm

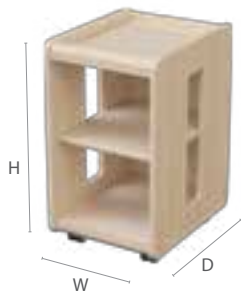

45326



45327

W 70 x D 45 x H 61 cm



45328



45329



45332



45331



45330

W 70 x D 45 x H 86 cm



45333



45334

W 103.5 x D 45 x H 61 cm



45335



45340



45339



45338



45341



45337

W 103.5 x D 45 x H 86 cm



45343



45342



45344

Curved



45348 50 x 50 x 86 cm



45345 113.5 x 45 x 86 cm



45347 50 x 50 x 61 cm



45346 113.5 x 45 x 61 cm

Ultra Storage Units

This collection was designed to fulfil the storage needs of any learning environment. These tray storage units are flexible and versatile. The wonderful natural look gives these storage units a neutral look matching many different layouts. You can choose from these four options for the back of each storage unit:

- Open shelving
- Wooden back.
- Transparent back.
- White board back.



Heavy-duty lockable casters





Wooden back is a good choice for using storage units placed on the wall. It gives you plenty of space to keep things organized in a safe way.



Open shelving give an easy overview and easy reach. It also enables you to use the unit as a divider to create different layouts.



Transparent back allows light to pass through providing a naturally shining in the room. You can also use the unit as a divider so the light can go through from all sides.



White board back is a clever use for the storage units. It also enables you to use the unit as a divider, and give children the opportunity to use it for unlimited imagination.

W 69.7 x D 40 x H 58 cm

Ultra Storage Units



Wooden back 64300



Open shelving 64301



Transparent back 64302



White board back 64303



Wooden back 64305



Open shelving 64306



Transparent back 64307



White board back 64308



Wooden back 64310



Open shelving 64311



Transparent back 64312



White board back 64313

W 103.6 x D 40 x H 58 cm



Wooden back 64315



Open shelving 64316



Transparent back 64317



White board back 64318

W 103.6 x D 40 x H 58 cm



Wooden back 64320



Open shelving 64321



Transparent back 64322



As well as looking attractive, this of tray storage units are 64323



Wooden back 64325



Open shelving 64326



Transparent back 64327



White board back 64328



Wooden back 64330



Open shelving 64331



Transparent back 64332



White board back 64333



Wooden back 64335



Open shelving 64336



Transparent back 64337



White board back 64338

W 69.7 x D 40 x H 79.5 cm

Ultra Storage Units

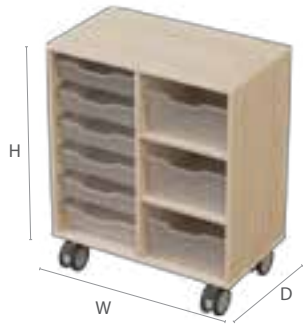

Wooden back 64340



Open shelving 64341



Transparent back 64342



White board back 64343



Wooden back 64345



Open shelving 64346



Transparent back 64347



White board back 64348

W 113.5 x D 40 x H 58 cm



Wooden back 64360

Transparent back 64361

W 113.5 x D 40 x H 79.5 cm



Wooden back 64365

Transparent back 64366

W 113.5 x D 40 x H 58 cm



Wooden back 64350

Transparent back 64351

Wooden back 64355

As well as looking attractive, this of tray storage units are 64356

W 100 x D 100 x H 58 cm



Corner open shelving 67375

Materials Cabinets

The style of this collection is based on following curves, organic forms and natural colour. The beauty of high quality beech wood is proven in each piece in this collection. It can be used in both Montessori classrooms and normal classrooms. Some cabinets are designed according to some of Montessori materials such as Pink Tower or Brown Stairs materials.





Heavy-duty lockable casters



As well as looking attractive, this series of storage units are flexible and versatile. This collection was designed to fulfill the storage needs of any learning

W 70 x D 40 x H 42 cm

W 103.5 x D 40 x H 42 cm



45440



45441

W 70 x D 40 x H 69 cm



45442



45443

W 70 x D 40 x H 96 cm



45444



45445

W 103.5 x D 40 x H 69 cm



45446



45447



45448

W 103.5 x D 40 x H 96 cm



45449



45450



45451

W 113.5 x D 40 x H 42 cm



45452

W 103.5 x D 40 x H 69 cm



45453

W 113.5 x D 40 x H 96 cm



45454

Mobile Book Browser Units

Each unit features easy-access bins for children to choose and pick books. Available in three designs: two bins, four bins, four bins with drawers. Supplied assembled.



35.6 x 45 x 37 cm

45152



69.4 x 45 x 60 cm

45151



69.4 x 45 x 37 cm

45153

Curved Storage Box Units

These smooth designed storage units are very helpful for reading corners. Its curved back and module design are ideal for making different corners depending on the space available. Supplied assembled.



91.8 x 36.9 x 81.6 cm

45150



Double Sided Display Book Units

In these units, you can display the books on both sides. There are two designs with drawers and without drawers. Units are suitable for books and magazines. Supplied assembled.



Available with Casters



80 x 40 x 60 cm

45158



69.4 x 45 x 90 cm

45154



103.2 x 45 x 120 cm

45155



80 x 40 x 100 cm

45157

Coat locker unit

These sturdy units provide convenient storage space for organizing classrooms. It is available in double, triple and quadruple units. Each unit contains two plastic trays with anti-fall safety runners included. Also it can be equipped with shelf for shoes. Made of high quality MDF.



138 x 40 x 112 cm

64101



103.6 x 40 x 112 cm

64100



70.2 x 40 x 112 cm

64099

Room Dividers





Room Dividers

Fun & functional!! With these dividers, organizing play rooms or classrooms into functional areas will be an easy task. It also helps to utilize space in a better way and constantly change it. In addition, children can have fun with these dividers, as they can write on the white board or colour on the transparent surface. The frame is made of high quality beech wood.



Size : 150 x 75 cm





 <p>Zigzag</p> <p>45800</p>	 <p>See through</p> <p>45801</p>
 <p>Fence</p> <p>45802</p>	 <p>Transparent</p> <p>45803</p>
 <p>White Board</p> <p>45804</p>	 <p>Wooden</p> <p>45805</p>

Room Dividers-Small

High quality, durable and functional wood modular room dividers. With these dividers, the creation of a separate play areas within a large room will be easy. These dividers are ideal for organising classroom area and creating a variety of spaces for playing, reading, drawing and so on. Also they are great for creating an infant or child play area as a self-contained area. In addition, children can have fun with these dividers, as they can write on the white board or colour on the transparent surface. The frame is made of high quality beech wood.

Size : 75 x 75 cm



<p>Small Fence</p> 	<p>Small See through</p> 
<p>45806</p>	<p>45807</p>
<p>Small White Board</p> 	<p>Small Transparent</p> 
<p>45808</p>	<p>45809</p>
<p>Small Wooden</p> 	
<p>45810</p>	

Platforms





Platform

These platforms are available in 9 shapes in 3 different heights. The varying heights encourage movement for little children. It can also be used as a playing corner. Handles are available to move and carry easily. High units have a tunnel system to add more fun for toddlers to crawl under. Surfaces are covered with heavy-duty carpets or a safe mirror.





<p>112.5 X 75 X 30 cm 45968</p>	<p>75 X 75 X 30 cm 45960</p>	<p>112.5 X 75 X 45 cm 45963</p>
<p>75 X 75 X 45 cm 45967</p>	<p>75 X 75 X 15 cm 45962</p>	<p>75 X 37.5 X 15 cm 45964</p>
<p>75 X 75 X 15 cm 45961</p>	<p>75 X 75 X 15 cm 45966</p>	<p>75 X 75 X 15 cm 45965</p>

Role Play





Children Play Kitchen

Our natural look kitchen set will make your home corner the most attractive in town! In this kitchen set we have combined play value with the highest quality, durability and, of course, value for money. There are 3 units in this set: (Cooke/oven -Sink / Washing Machine-Fridge). All units are constructed from quality lacquered beech wood which has a tough protective finish. It is designed to withstand a busy environment.



35 x 40 x 85 cm **21625**

35 x 35 x 52 cm **21626**

35 x 35 x 52 cm **21627**





21566
Iron 16.4 x 10.3 x 10 cm
Iron table 82.5 x 28 x 55 cm



21571
L 55.3 X W 34 X H 55.3 cm

Role play Iron Set

This natural looking ironing set has been specially designed to be true to life. Little ones adore role play and pretending and can keep them happy for hours. It comes with a wooden iron & ironing board that can be folded flat for storage.

Role play Clothes Rack

This beautiful natural look child-size clothes rack will keep the children happy for hours, super role playing fun! It can be folded flat for storage. Compatible with the iron set.

Fantasy dress-up unit

Children just love playing dress up, it is so much fun! This Dress-up unit has 10 hooks for costumes, a top shelf for hats or smaller items, and three plastic transparent trays in the base. Heavy-duty casters included for mobility. Full-length acrylic mirrors on both ends. It is a timeless piece of furniture to be added to pre-schools or activity centres.

45820

Size : 103 x 45 x 120 cm



Children's lounge

This high quality lounge setting is an attractive addition to pre-school classrooms or role play areas. Frames are manufactured from natural solid wood. Back and seat cushions are made from high density fibre covered with either fabric or leather covering. It encourages social interaction for children as they sit on the lounge during play or when reading books. It is a timeless design that will create a warm and inviting atmosphere.



43906
Lounge sofa
Lounge chair
Lounge table

Available in Two Colors



Lounge table
60 x 45 x 40 cm

43909



Lounge chair
49 x 52 x 60 cm

43908



Lounge sofa
89 x 52 x 60 cm

43907

Pretend Market Stall

The market stall with striped fabric canopy is the perfect way for children's imagination to grow wild. It encourages children to learn through role play and social activity as they open up their very own market. Modular design for flexible learning spaces. Position against a wall or create an island with other of our role play or storage units. Made from Solid European Birch Ply. Finished with a durable, environmental UV coating for premium protection. This solid unit comes with braked wheels for easy repositioning within your classroom. Trays and Accessories not included!



45825
Size : 103 x 45 x 120 cm





Activity Play Table

These tables are designed especially for play. The stand-up working height makes them perfect for playtime. Its colorful silk-screened landscape board was built to last. Curved edges for safety. Transparent plastic drawers for easy storage of toys. It can be used from all sides for group play.



Plastic Trays



116 x 78 x 40 cm **45187**



116 x 78 x 56 cm **45188**



75 x 75 x 40 cm **45189**



Plastic Trays



75 x 75 x 56 cm **45190**



Soft Seating









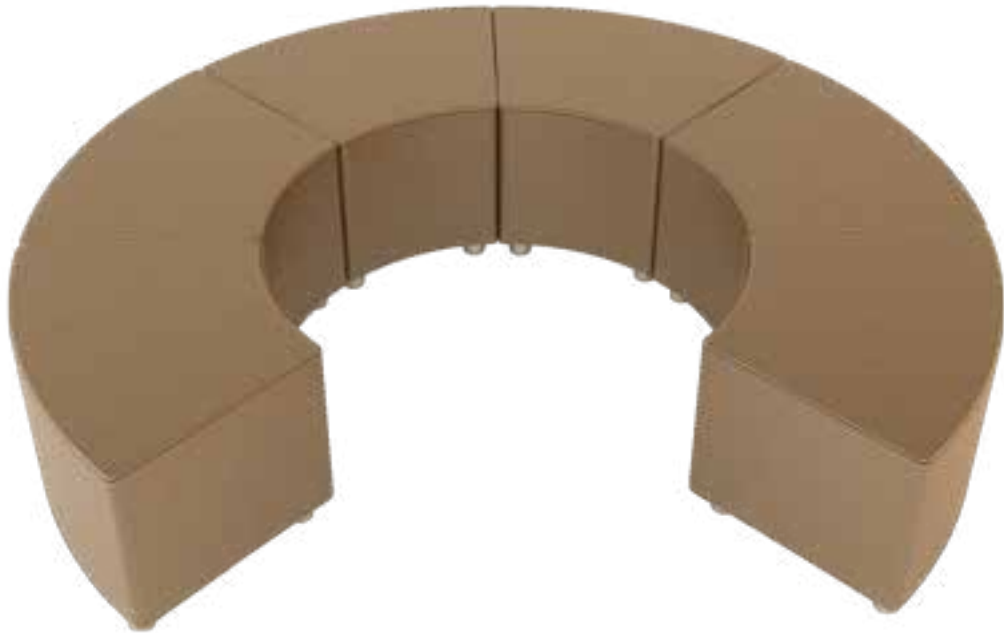

Curves - Soft Seating

Little reading corners, open spaces, reception areas all come to life, with our line of pre-school and school seating, as they welcome every passer-by for a little repose. Six shapes snuggle into one another as you fit them together like puzzle pieces to create 3D masterpieces of art. It can compose different formations to give a natural breath to your interior.





 <p>Circle</p>	 <p>Semi-circle</p>	 <p>Bites</p>
<p>C2 H. 31 cm - ø 45 cm - 43530</p> <p>C3 H. 35 cm - ø 45 cm - 43540</p>	<p>C2 H. 31 cm - ø 45 cm - 43533</p> <p>C3 H. 35 cm - ø 45 cm - 43543</p>	<p>C2 H. 31 cm - ø 45 cm - 43531</p> <p>C3 H. 35 cm - ø 45 cm - 43541</p>
 <p>Infinity</p>	 <p>Corner</p>	 <p>Big Circle</p>
<p>C2 H. 31 cm - 90 cm - 43532</p> <p>C3 H. 35 cm - 90 cm - 43542</p>	<p>C2 H. 31 cm - ø 45 cm - 43534</p> <p>C3 H. 35 cm - ø 45 cm - 43544</p>	<p>C2 H. 31 cm - ø 60 cm - 43535</p> <p>C3 H. 35 cm - ø 60 cm - 43545</p>



Soft Play





Multi Activity Soft Play

Children will have a lot of fun with these geometric shapes. Each shape's edge invites another shape to nestle encouraging interactive play among the soft shapes. The warm natural colours helps children to relax and concentrate. Made of high-density foam covered with leather. Easy to clean with soapy water. Recommended for ages between 2 and 3 years.

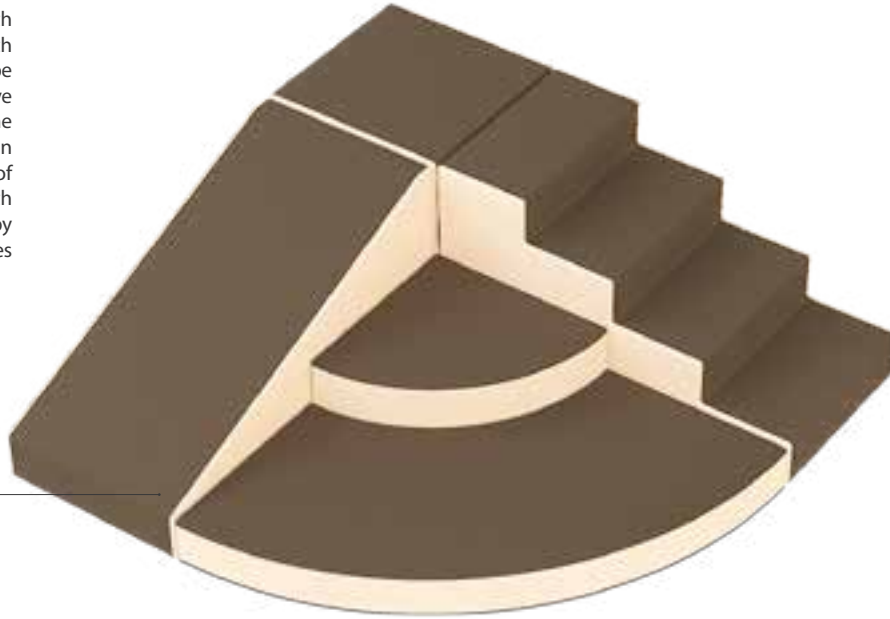

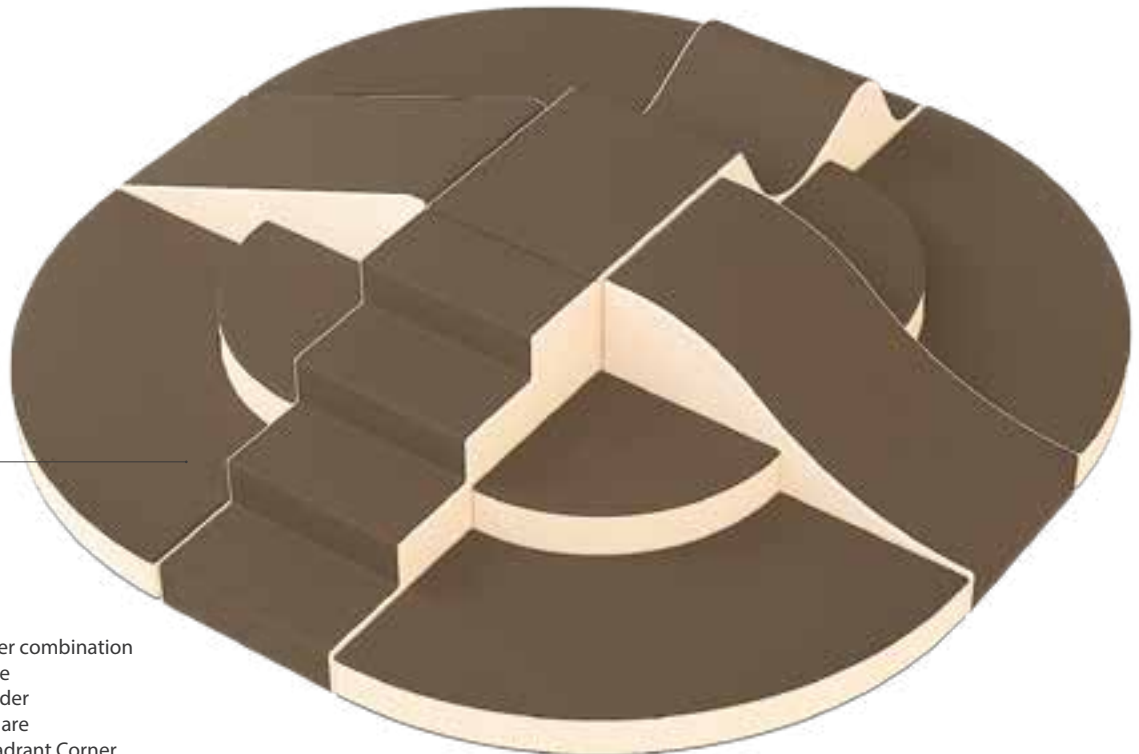

- Corner combination
 - Slide
 - Ladder
 - Square
 - Quadrant Corner
 - Semi-Circular Mat



- Center combination
 - Slide
 - Ladder
 - Square
 - Quadrant Corner
 - Semi-Circular Mat
 - Gentle Wave
 - Two waves

 <p>Slide</p>	 <p>Ladder</p>	 <p>Gentle Wave</p>
<p>100 x 50 x 50 cm 45980</p>	<p>100 x 50 x 50 cm 45981</p>	<p>100 x 50 x 50 cm 45982</p>

 <p>Two waves</p>	 <p>Square</p>	 <p>Quadrant Corner</p>
<p>100 x 50 x 50 cm 45983</p>	<p>50 x 50 x 50 cm 45984</p>	<p>50 x 50 x 50 cm 45985</p>

 <p>Semi-Circular Mat</p>
<p>45986</p>

Tiny Toddler Soft Play

Our Tiny Toddler soft play will provide a safe place for toddlers to have fun while getting exercise. Each shape's edge invites another shape to nestle encouraging interactive play and gross and fine motor development. The warm, soft tones allow the child to relax and concentrate on their activities. Made of high-density foam covered with leather. Easy to clean with soapy water. The small Recommended for ages between 9 months and 2 years.

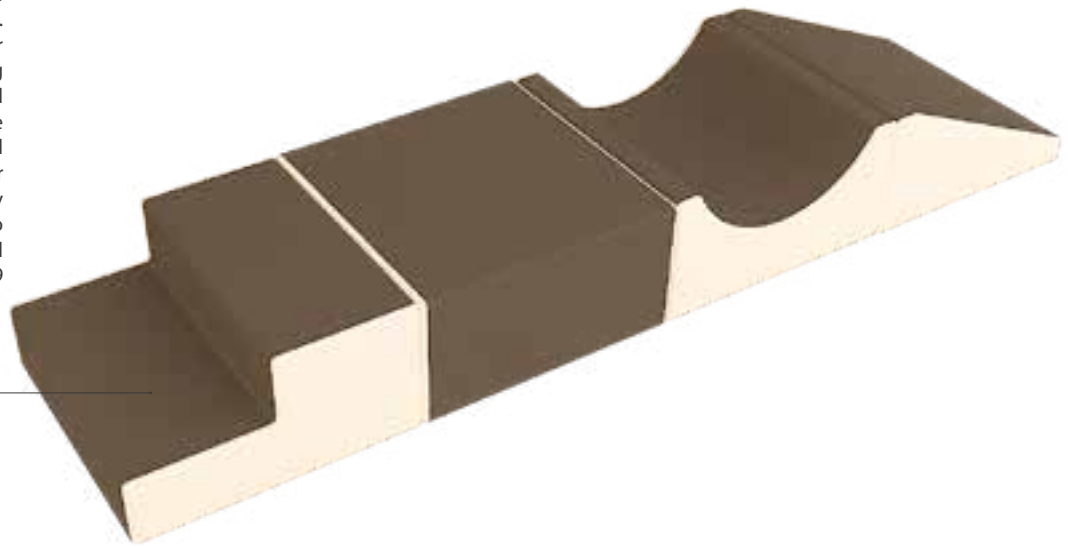

- - Two Steps Ladder
- Rectangular
- Hollow
- Small Slide



- - Two Steps Ladder
- Rectangular
- Hollow
- Small Slide
- Small Wave
- Quadrant Mat

		
<p>Rectangular</p> <p>50 x 25 x 50 cm 45990</p>	<p>Hollow</p> <p>50 x 25 x 50 cm 45991</p>	<p>Two Steps Ladder</p> <p>50 x 25 x 50 cm 45992</p>

	
<p>Small Slide</p> <p>50 x 25 x 50 cm 45993</p>	<p>small Wave</p> <p>50 x 25 x 50 cm 45994</p>

<p>Quadrant Mat</p> <p>45995</p>

Wooden Blocks





Large Hollow Blocks

Children can build, design and create amazing structures with these large blocks. These blocks offer hours of creative play, problem solving and mathematical reasoning enhancing logical/mathematical intelligences. Standard unit-block constructed with soft edges and smooth surfaces. A great, robust resource for child-initiated and collaborative play encouraging social intelligence. Bodily/kinesthetic intelligence is strengthened as children use their muscles to transport and build. Made of high quality natural wood with non-toxic paints conforming to European toy safety standards.



Large Hollow Blocks		
Shapes	Quantity	Size
	4	56 x 14 x 1.2 cm
	2	112 x 14 x 1.2 cm
	2	28 x 14 x 14 cm
	5	28 x 28 x 14 cm
	2	56 x 28 x 14 cm
	2	56 x 28 x 14 cm
Total	17	

31320
Large Hollow Blocks
Basic Block Module : 14 cm





Age 5+ **Pcs** 17 Pieces



Mini Hollow Blocks

Build, design and create your amazing structures with these beautifully made blocks. Made from pressure treated timber, enabling endless outdoor fun - plus you don't need to worry about them getting wet as they are made for all weathers! A great, robust resource for child-initiated and collaborative play

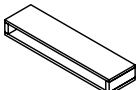

Mini Hollow Blocks		
Shapes	Quantity	Size
	10	14 x 14 x 7 cm
	6	28 x 14 x 7 cm
	4	56 x 14 x 7 cm
	4	28 x 14 x 7 cm
Total	24	

31322
Mini Hollow Blocks
Basic Block Module : 7 cm

Age 3+ **Pcs** 24 Pieces



Large Building Blocks/Wooden

Perfect toy to allow your children to be creative and stimulate their imagination. Building towers and other structure develops their motor skills which helps develop bodily/kinesthetic intelligence. It also enhances logical / mathematical intelligence by developing the children's constructive and perceptive skills. Playing with blocks reinforces the interpersonal intelligence as children are encouraged to play together. Made of high quality natural wood with non-toxic paints conforming to European toy safety standards



31314
Large Building Blocks-Wooden
Basic Block Module : 3.5 cm

Age 2½+ Pcs 50 Pieces

Basic Building Blocks/Wooden

Blocks are the epitome of open-ended toys. They allow children to design, invent and create. Our basic building blocks set make the perfect first blocks. Children can explore concepts of balance, stability as they construct enhancing logical / mathematical intelligence. Blocks are proportional in size, which allows for symmetrical design and construction. Playing with blocks reinforces the interpersonal intelligence as children are encouraged to play together. Patterns are added to the colored set to stimulate matching and comparing skills. Made of high quality natural wood with non-toxic paints conforming to European toy safety standards.



31312
Basic Building Blocks-Wooden
Basic Block Module : 3.5 cm

Age 2½+ Pcs 25 Pieces

Mini Building Blocks-Wooden

Our Mini building blocks encourage creative play and healthy social interaction reinforcing the interpersonal intelligence. Toddlers will love to play with them because they are velvet-smooth and all edges are evenly curved. All the shapes are simple geometric shapes, large enough so that there is no danger if they by accident end up in your child's mouth. Patterns are added to the colored set to stimulate matching and comparing skills developing logical / mathematical intelligence. Made of high quality natural wood with non-toxic paints conforming to European toy safety standards.



31310
Mini Building Blocks-Wooden
Basic Block Module : 3.5 cm

Age 1+ Pcs 16 Pieces



**Head Office
& Edu fun® Middle East Subsidiary
Dubai -UAE**

- Showroom & Outlet
- Marketing & Sales Office
- R&D Department
- Warehouse & workshop

No.1, ASAS Building, Maliha Rd
Industrial Area 18, Sharjah, UAE
Tel.: +971 6 556 8255, Fax: +971 6 556 8334
Cell: +971 50462 2134,
e-mail: uae@edu-fun.com
web: www.edufun.com

**Europe Subsidiary
Edu fun® GmbH
Deutschland**

- Showroom & Outlet
- Marketing & Sales Office
- Warehouse

Neuried Ichenheim - Germany
Rheinstrasse 7 - 77743 Neuried
Tel.: +49 [0]7807 / 0000
Fax: +49 [0]7807
e-mail: info@edufun.de
web: www.edufun.de

**Australia & Oceania Subsidiary
Edu fun® Pty Ltd
Australia**

- Marketing & Sales Office
- Warehouse

1 Envision Close , 19 Corporate terrace
Pakenham, Victoria 3810,
Australia
Tel.: 1300-EDUFUN
Tel: + 61 402 266 852
Email: aus@edu-fun.com
web: www.edu-fun.com

**MENA Region Subsidiary
Edu fun® MENA
Egypt**

- Showroom & Outlet
- Production Facilities
- Technical & OEM Office
- Marketing & Sales Office
- Warehouse

No. 27 Mohammed Tawfik Diab
Makram Ebied, Nasr City
Cairo, Egypt
Tel.: + 202 227 07 649
Fax: + 202 227 07 571
Email: egypt@edu-fun.com
web: www.edu-fun.com



**Head Office
Dubai -UAE**

No.1, ASAS Building, Maliha Rd
Industrial Area 18, Sharjah, UAE
Tel: +971 6 556 8255, Fax: +971 6 556 8334
Cell: +971 50462 2134,
e-mail: uae@edu-fun.com
web: www.edufun.com

