



Furniture for
Early Learning Spaces



2022



Introduction	04	Teacher Chair	98
European standards	08	Stool & Benches	102
Harmony Line	12	Soft Seating	108
Elegance Tables	16	Storage Units	114
Chairs (Deluxe - Elegance)	30	Ultimate.....	116
- Woody	34	Materials Cabinets	136
- Star	35	Coat Locker & Cubbies	140
- Classic S	36	Soft Play	144
- Classic Plus	37	Large Soft Play.....	146
- Classic	38	Small Soft Play	148
Prime Line	42	Dividers	152
Ultra tables	46	Platform	162
Chairs (Simple)	60	Large Platform	164
- Dynamic	62	Small Platform	166
- Action	63		
Grand Line	66		
Tables (Flexo - Multi)	70		
Chairs (Simple)	92		
- Flexo L	94		
- Flexo N.....	95		



Toddler	168
Chairs	172
Tables	176
Reading Centres	182
Mobile Book Browser Units.....	184
Curved Storage Box Units.....	185
Double Sided Display Book Units...	186
Art Centres	188
Equipment storage unit	190
Easels	192
Drama Centres	194
Kitchen	196
Iron Set & Cloth Rack	198
Children's lounge	200
Dress unit	202
Activity Play Table.....	203



Introduction

Welcome to our World

The background of our company goes back a long way, as the founders were educators with many years of experience in establishing schools. They believed in education as the best way for developing societies and people. This belief was the motivation to establish our company and is still driving it through years and years of success.



Children are our priority

EduFun® products are always designed with children in mind. With our experience in the educational field, we carefully assess children's needs and how classroom furniture can stimulate their development. Classrooms should be inviting environments that make children feel good to be there.



We listen carefully

At EduFun®, we strive to serve and support our customers around the world. We always listen to our customers' concerns and demands. We develop our products upon their needs. You will find our furniture is modular and adjustable to be able to change the learning environment all the time.



We care about our environment

Since the first day, we chose to use wood in our production, to create a healthy warm environment for children. Wood is the most environmentally friendly raw material, which is healthy for our climate, prevents climate change and has zero waste. The beauty of wood is that it engages all our senses. It is warm, rich and affecting, and its surface has a tactile and sensuous strength. We use real wood from sustainable forestry to help protect our environment. We consider it our responsibility to contribute to the preservation of the environment.

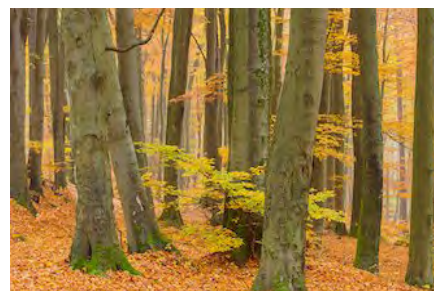

Production

Since EduFun® first began, we have been expanding our production lines to fulfill growing demand. Likewise, the collections of the EduFun® range have been continuously expanding to meet our customers' desires.



New state-of-the-art machines have been added to our production lines offering quality and on-time production. We can develop new product ranges with the execution of OME products with our factories and our four production lines (solid wood, panel board, tube bending, wooden toys and puzzle).

- 1- Solid Wood Production Line
- 2- Panel Board Production Line
- 3- Tube Bending Production Line
- 4- Educational Resources Production Line



Materials

EduFun® aims to build sustainable long-lasting furniture for the most active children. Besides smart designs, the durability depends on using the highest quality materials. To that end, EduFun® imports high quality natural European beechwood and the longest lasting non-toxic German lacquers. We spare no expense to make certain you're getting the best products made of the highest quality materials.



Introduction

Design

EduFun® designs furniture for preschool and kindergarten children, for educators, and for learning institutions to make everyone at your school safe, happy and comfortable from the start of the day until the last moment of the day. EduFun® designs are synonymous with creative, versatile, and practical learning spaces. Our Research and Development Department has collaborated with experts from all over the world to research, develop and create innovative products. Our products include ergonomically designed furniture for growing children, storage units of all kinds for organised and efficient classrooms, and reading centres with play corners and role play furniture for a complete and holistic learning experience. The finest materials, vibrant colours and exquisite textures come together for relentless beauty and the high durability of our furniture will look new for years to come. EduFun® designed for you all that you dream of in your preschool and kindergarten learning spaces.

Please note: The colours, design and specifications in this catalogue may not correspond to the actual ones. EduFun® reserves the right to change any specifications and make upgrades of its products at any time without notice. Information in this catalogue was correct at the time of printing. While our team has made every effort to ensure the accuracy of information, EduFun® cannot accept any responsibility for any errors or omissions and this catalogue does not oblige any form of contract.



Dreams can come true

We have a very wide range of products that can provide any customer with what they need. Our products vary from chairs, tables, storage units, platforms and role play furniture. However, sometimes special specifications are requested. With our production capabilities, we can make your dreams come true.



International Standards

EduFun® is keen on our children's health and for that reason the product range and production facilities are certified by meeting the latest high international standards of safety such as:

- BS EN 1729
- ANSI/BIFMA
- ISO 9001
- ISO 14001
- OHSAS 18001



BS EN 1729
For dimensions



ISO 9001
ISO 14001
OHSAS 18001

Central Locations

EduFun® group is streamlining its activities to keep pace with the growing markets and is becoming a leader in the region and as an international player. As a place to do business, and as a hub for the region and beyond, the United Arab Emirates (UAE) continues to be increasingly important, relevant and attractive to businesses from around the world. For these reasons, we have moved our head office to UAE. EduFun® produces and ships from Egypt, the historic hub of trade and shipments. Our shipping ports are centrally located, with northern ports on the Mediterranean Sea serving Europe and the Americas and eastern ports on the Red Sea serving Africa, Asia and Australia, meaning you get your order in record time.

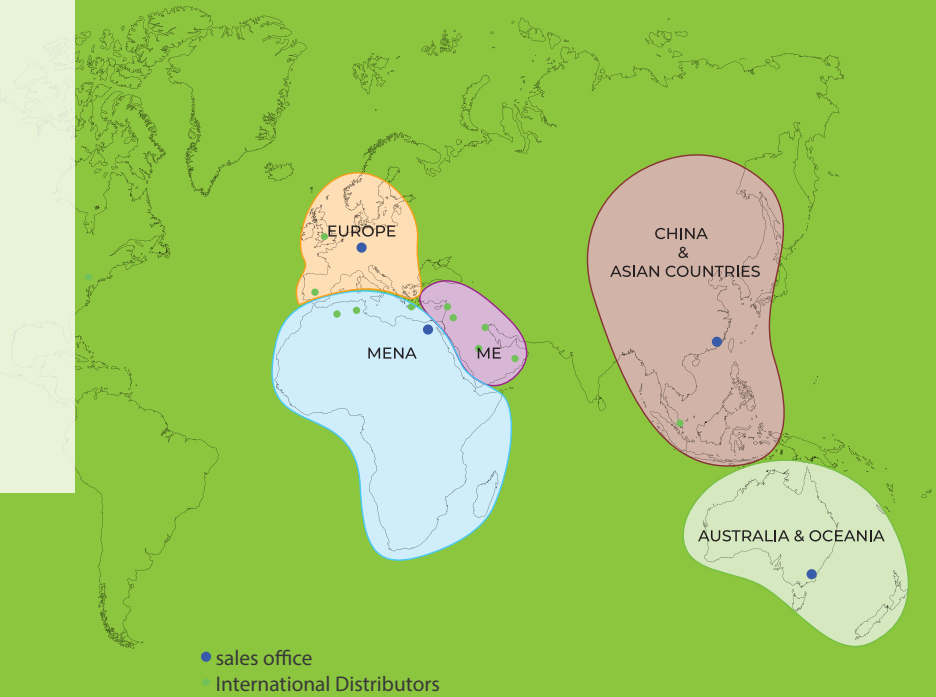

Visit Us

Our customers are warmly invited to visit our factory in Egypt or any of our subsidiaries in Germany, Australia or China. We are sure that visiting our integrated manufacturing complex will leave a positive impression on you. We are not just a manufacturer, but we are artists as well. You can feel that yourself when you meet in person with our skilled workers under the supervision of well-educated professional engineers, seeing how they are working with the latest technological machinery and how they turn a piece of tree into a piece of art.



What benefits can you get from buying from us?

Zero cCustoms duty is one of the most biggest advantages that you can get if you import directly from Egypt and that's why we have established our factory in Egypt from the early beginning; as Egypt is a signatory to several multilateral trade agreements, which give a great potential to its export products. The following are the "Trade Agreements" which between Egypt as country of eExport and the whole world:

- Egypt - EU Partnership
- Mercosur Agreement
- COMESA Agreement
- EFTA Agreement
- Egypt – Turkey Free Trade Agreement
- Agadir Agreement
- League of Arab States
- Generalized system of preferences (G.S.P)
- Generalized System of Trade Preferences (G.S.T.P)



European standards

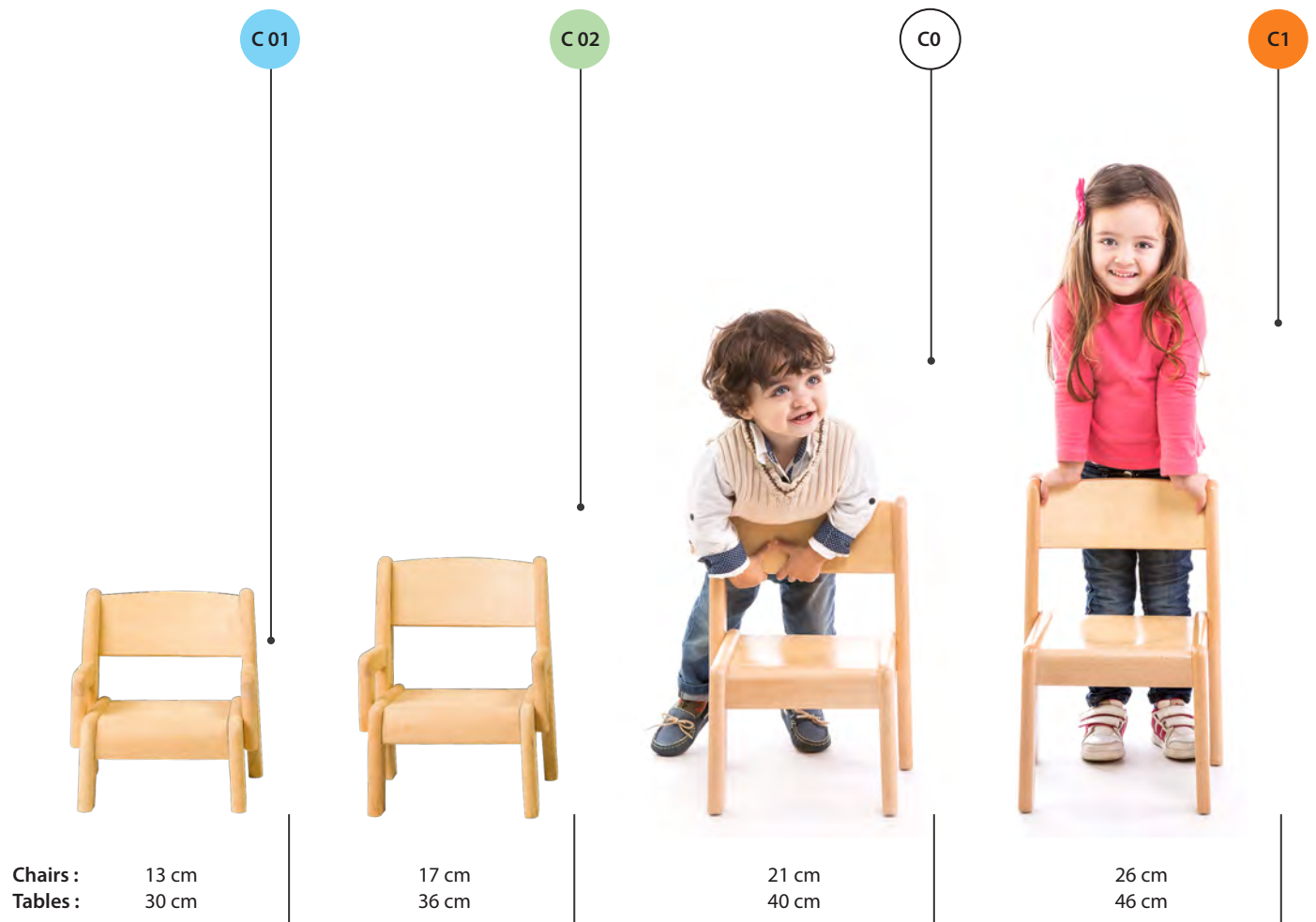

We design all our furniture collection according to the European standards for chairs and tables for educational institutions, which was approved in January 2007. Children should always use the appropriate size of chairs or table to ensure good posture and prevent causing problems or distortions for them while growing. Ergonomic seating requires adjustable furniture to suits different body heights.

In this table you can choose the correct seat and table height suitable for the student age:

BS EN 1729 European standards for chairs and tables

Children`s ages	0 - 2 yrs		0 - 2 yrs		2 - 3 yrs	
Chairs & Tables Symbol		C 01		C 02		C 0
Chairs seat height		13 cm		17 cm		21 cm
Tables height - Fixed legs		30 cm		36 cm		40 cm

Infant/toddler chairs & tables
Pages : 168-181



31 cm
53 cm



35 cm
59 cm



38 cm
64 cm

2 - 4 yrs		4 - 6 yrs		6 - 8 yrs		8 - 11 yrs	
	C 1		C 2		C 3		C 4
	26 cm		31 cm		35 cm		38 cm
	46 cm		53 cm		59 cm		64 cm

Preschool/elementary chairs & tables
Pages : 12 - 97

European standards

EduFun® colours variety

We have different materials in our catalogue with a variety of bright and neutral colours to meet different tastes and activities. Please always remember to choose your colour code while you are choosing your piece of furniture.

HPL / Melamine Colours options

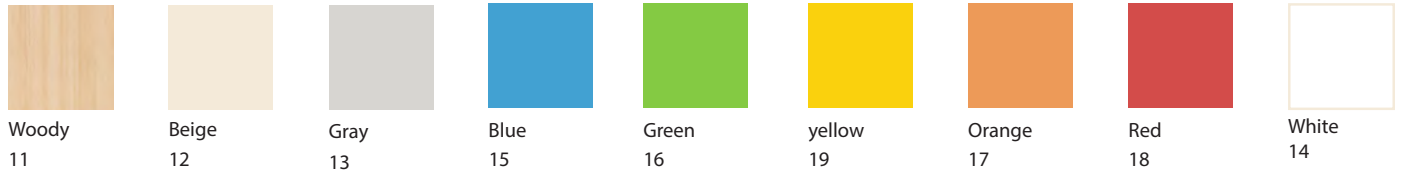

Birch plywood Water base Colours options

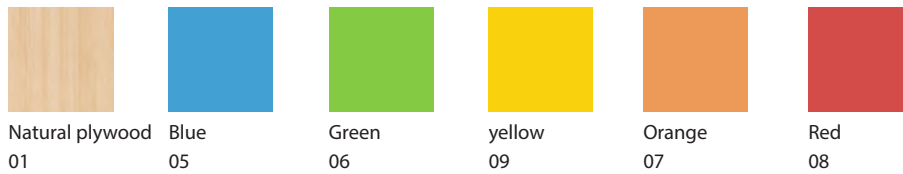

Shell Colours options

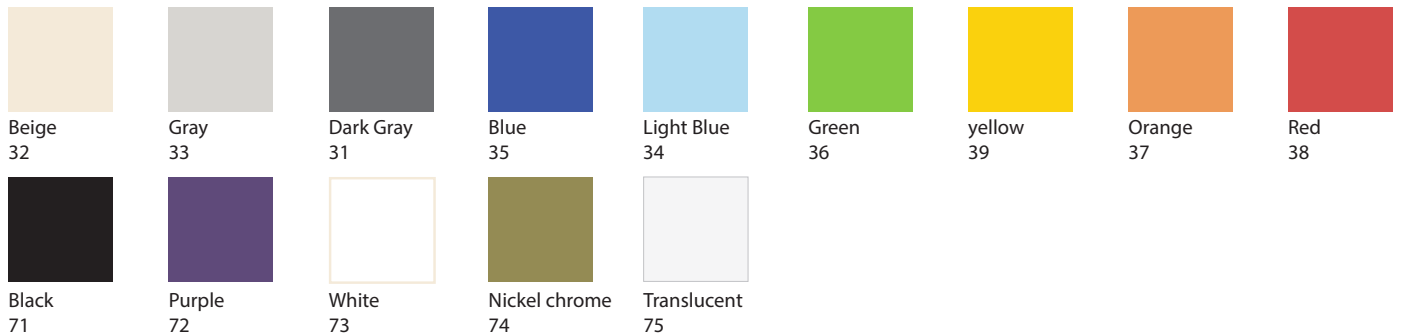

Metal Frame Colours options

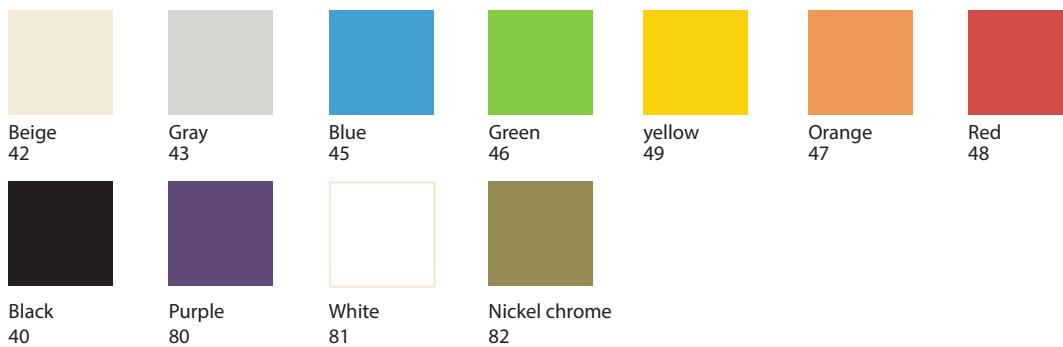

Leather Colours options

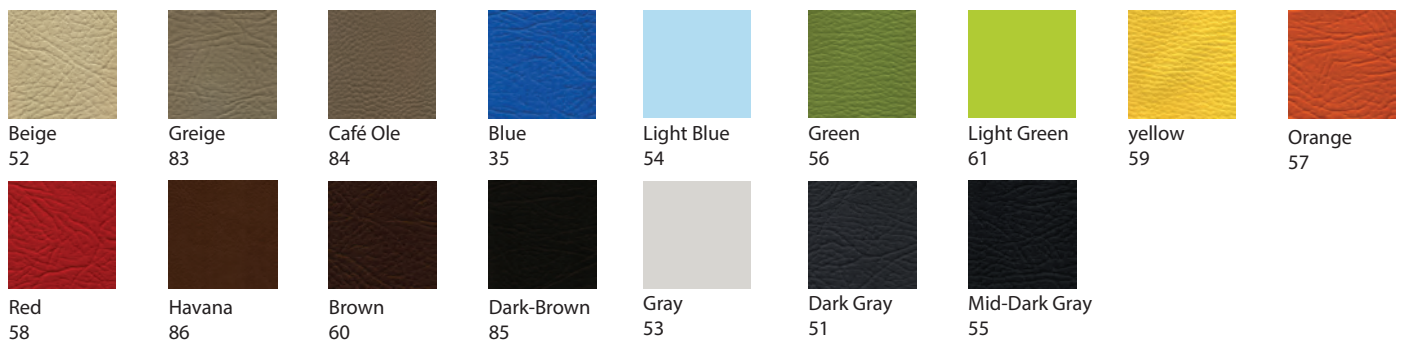

* Colours may vary from pictures

How to Order

Section Name → Harmony Line

Product Name → Elegance Chair

These beautifully crafted stackable chairs would look great in any classroom. Each chair is made of solid, top-quality lacquered beechwood and is built to last. Five convenient seat heights are available to correspond with Elegance tables. Available with arms.

Product Details

30

www.edu-fun.com

Chairs & Tables	Chair Size	Chair Code	Recommend Tables Height
	28.5 x 28.5 cm - H: 21 cm	43201	40 cm
	28.5 x 28.5 cm - H: 26 cm	43202	46 cm
	30 x 30 cm - H: 31 cm	43203	53 cm
	30 x 30 cm - H: 35 cm	43204	59 cm
	36 x 36 cm - H: 38 cm	43205	64 cm

Seat & back colours with wooden frame

• Natural plywood 01-01 • Blue 02-01 • Green 03-01 • Yellow 04-01 • Orange 07-01 • Red 08-01

Chairs & Tables	Chair Size	Chair Code	Recommend Tables Height
	28.5 x 28.5 cm - H: 21 cm	43206	40 cm
	28.5 x 28.5 cm - H: 26 cm	43207	46 cm
	30 x 30 cm - H: 31 cm	43208	53 cm
	30 x 30 cm - H: 35 cm	43209	59 cm
	36 x 36 cm - H: 38 cm	43210	64 cm

Seat & back colours with wooden frame

• Natural plywood 01-01 • Blue 02-01 • Green 03-01 • Yellow 04-01 • Orange 07-01 • Red 08-01

with arm rest

Coloured back & seat with wooden frame

• For Example

Chair Code → **43205 - 01 - 01**

Your choice of colour

Stage → Chair Code

Chairs & Tables	Chair Size	Chair Code	Recommend Tables Height
	28.5 x 28.5 cm - H: 21 cm	43201	40 cm
	28.5 x 28.5 cm - H: 26 cm	43202	46 cm
	30 x 30 cm - H: 31 cm	43203	53 cm
	30 x 30 cm - H: 35 cm	43204	59 cm
	36 x 36 cm - H: 38 cm	43205	64 cm

Chair Size ← Chair Height → Suitable Table Height

31

Section Name → Harmony Line

Product Name → Rectangular Elegance Table

120 x 60 cm

Table Plan

Table combination

60 cm

120 cm

Table Code

Table Top color

Table Frame color

How to Order

20

www.edu-fun.com

• Please Select

Complete table	Table Component	C01	C02	C0	C1	C2	C3	C4
	Table-Top with wooden frame 120 x 60 cm	69921						
	4 Wooden legs	69968	69969	69970	69971	69972	69973	69974
	2 Wooden legs & 2 Wooden legs With Casters	-	-	69977	69978	69979	69980	69981

• Please Select

Legs / Rails Colours

• Please Select

Table-Top Colours

How to order Table Code Table-Top colour Code - Legs / Rails colour Code **44202 - 11 - 01**

Frame Style

Complete table

Table Component

C01 C02 C0 C1 C2 C3 C4

Stage

Table Top code

Table Code

Table with caster Code

Product Name & Size

• For Example

Table Code → **44335 - 11 - 01**

Your choice of colour

Harmony Line

**Natural European Beechwood:
The Classic Natural European Wood Series.**

Ergonomically Solid European beechwood chairs and table frames. Natural European birch plywood seat and back rest.

The harmony line has been developed with a vast range of products so you can create a natural looking environment, which helps children to learn efficiently. The construction and materials used ensures that it will last forever. With all modular designs, the natural look of our pieces transform classes into creative expressions, with infinite arrangements, and infinite possibilities. It is ergonomically designed for active children in their early years to gently encourage healthy posture.



Tables:

Tops made from:

- 22 mm thick MDF - (Medium Density Fibreboard).
- Laminated with HPL (High Pressure Laminate) with high scratch and shock resistance surfaces.
- New designed solid wood edges, curved and rounded for safety. No grooves when tables grouped or combined.
- Varnished solid beech wood edges, curved and rounded for safety.
- Available in wood grain and beige colours.
- 5 years guarantee.



Table frame made from:

- Varnished solid beechwood with rounded corners (according to European standards).
- Legs are fitted with glides to provide floor leveling and reduce noise.
- Legs come unassembled and can be easily fixed to the table tops frame using the strong metal fixing bracket.



Wooden Chairs

- Frame made from European beechwood.
- Seat and backrest made from curved multi-layered birch plywood.
- Comes assembled.
- Multi stack chairs.
- Wide range of seat and backrests available in natural or coloured range.
- Legs have a glide to protect floors and reduce noise.
- Very strong and can hold the weight of an adult.
- 5 years guarantee.

Harmony Line

We suggest the Elegance Table with the Elegance Chair or Deluxe Chair as the main choice in the harmony line. Any wooden chair - from our collection - can also be used with our Elegance Table. (pPage 26 to 33).



● Elegance Table



● Deluxe Chair



● Elegance Chair



Table combination

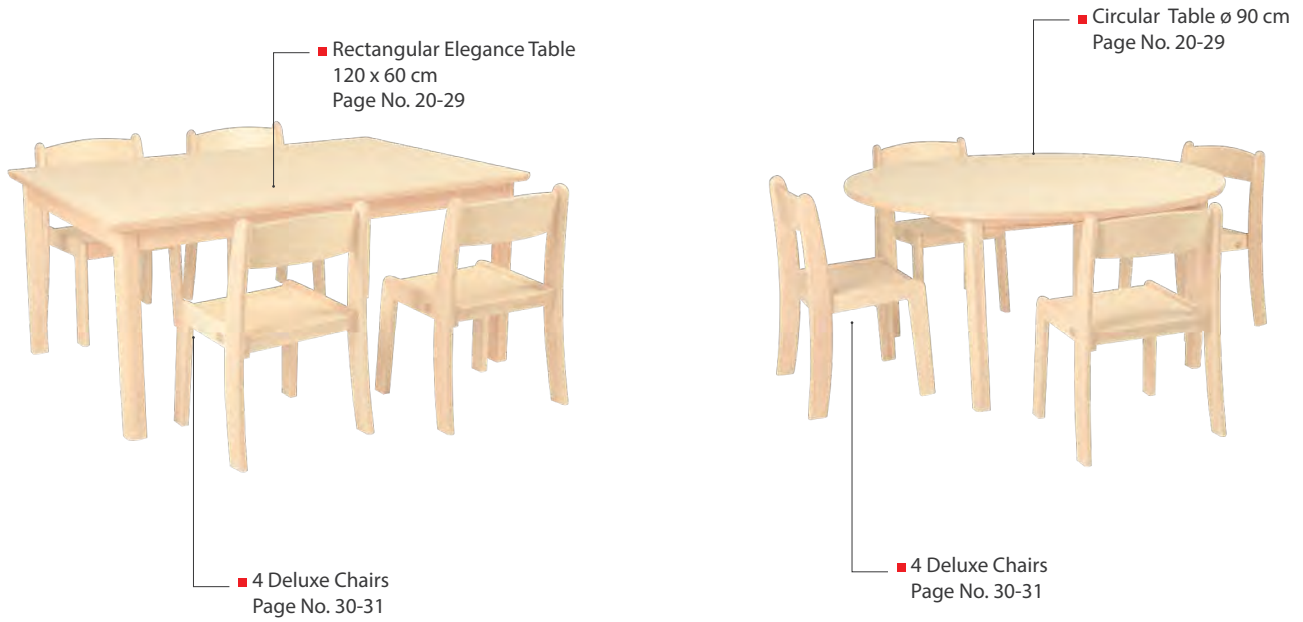

Another shapes of Elegance Tables



Legs / Rails Colours



Natural plywood
01

Table - Top Colours



Woody
11



Beige
12

Seat & back colours with wooden frame



Natural plywood
01-01



Blue
05-01



Green
06-01



yellow
09-01



Orange
07-01



Red
08-01

Harmony Line

Elegance Tables

Our lines of Elegance Tables come packed flat for your convenience. The tables are easily assembled with the simple instructions provided. When correctly assembled, our tables are solid, stable and durable. Tables come in 5 convenient heights and 6 functional shapes. All our tables are modular and can be arranged in many different configurations. Legs and rails are made of either:

- Solid wood.
- Metal.

Plastic glides or coasters can be added upon your request. Tabletops are made from extremely strong medium density fibreboard (MDF) laminated with high pressure laminate (HPL) (22 mm). Edges made from solid beechwood with protective varnish. They are gently smoothed and lightly rounded to avoid any risk or injury.



- Supplied unassembled



22mm MDF Laminated HPL solid beech edges

Tabletops 22mm thickness are made from extremely strong medium density fibreboard (MDF) insulation, which is stiff, has no knots and has fine edges. The tops are also laminated with high pressure lamination HPL (under heat [80-90 Celsius] and pressure [250 kgs/m²]). No added formaldehyde (NAF). Ivory colour or beige wood theme. Edges made from solid beechwood painted with protective varnish, with safe and gently and rounded edges.



A Special rounded Edge design without spacing when tables are grouped (shark nose Edges)



Easy to clean

HPL VS. MELAMINE

High Pressure Laminate is commonly referred to as HPL and is manufactured under 1000kg per-square-metre of pressure pressing down on 6 to 8 layers of kraft paper bonded with phenolic resin glue, then topped by a polymer facing. Applications include bench-tops, joinery, wall panelling, lockers, and tables where scuff resistance is prominent important.

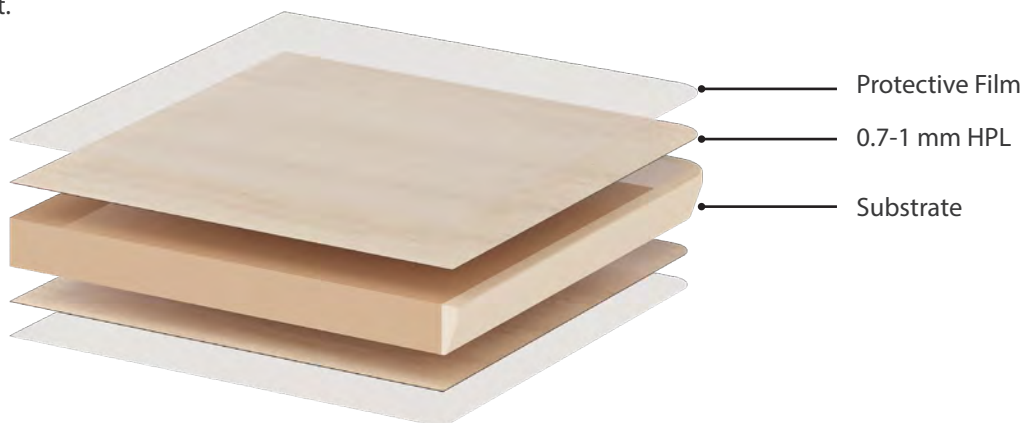

When you purchase HPL sheets, it is generally not attached to a substrate such as MDF or craft wood. Attaching it to a timber substrate is an entirely separate process which that is commonly referred to as "laying up the laminate". It should be attached to a dense substrate (base wood layer) for best results. We use moisture resistant Medium Density Fibreboard (MDF) as the substrate and ABET High-Pressure Laminates as the decorative surface. This results in the best possible finish with maximum durability.

Harmony Line

Elegance Tables

Wooden Legs

There are 5 different heights for these wooden legs, which is convenient to children of different heights. These tables come packed flat for your convenience. The tables are easily assembled with the simple manual instructions provided.



Connection



Easy to assemble



Available with or without Casters



Glides

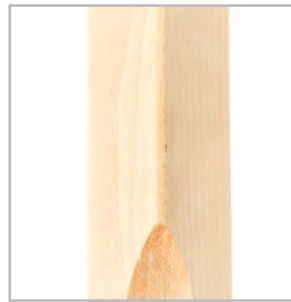

Rounded Edges

Table Heights

- C4 64 cm
- C3 59 cm
- C2 53 cm
- C1 46 cm
- C0 40 cm
- C01 36 cm
- C02 30 cm

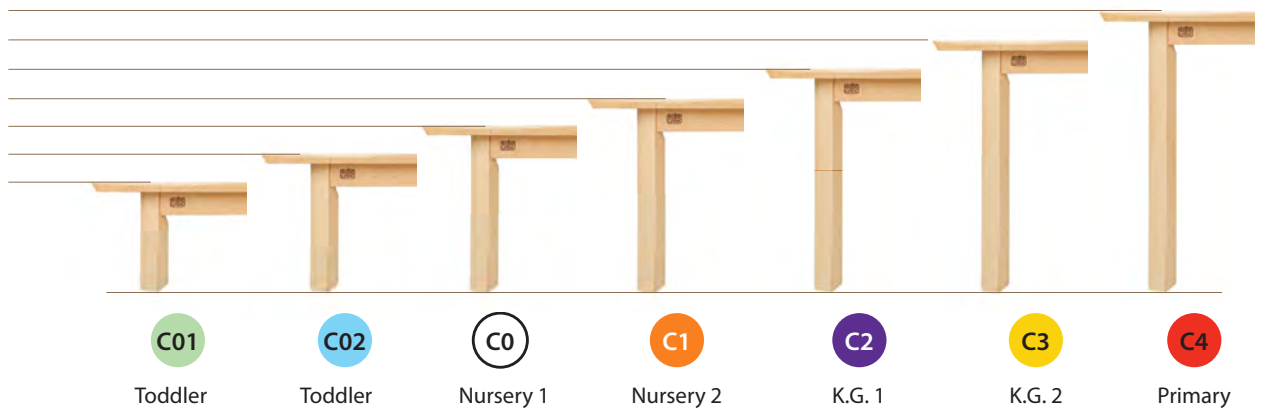



Harmony Line

Rectangular Elegance Table

120 x 60 cm

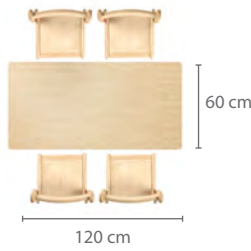
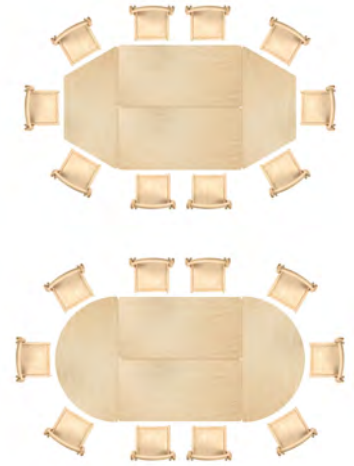

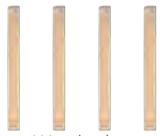

Table combination



● Please Select

Complete table	Table Component	C01	C02	C0	C1	C2	C3	C4	
  Rectangular Table 120 x 60 cm	 Table -Top with wooden frame 120 x 60 cm	69921							
	 4 Wooden legs	69968	69969	69970	69971	69972	69973	69974	
	 2 Wooden legs & 2 Wooden legs With Casters	—	—	69977	69978	69979	69980	69981	

● Please Select
Legs / Rails Colours

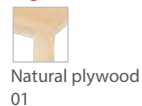

● Please Select
Table - Top Colours

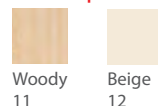

Rectangular Elegance Table

80 x 60 cm

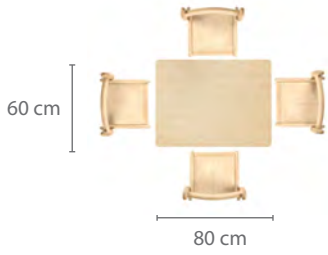



Table combination



● Please Select

Complete table	Table Component	C01	C02	C0	C1	C2	C3	C4
  Rectangular Table 80 x 60 cm	 Table -Top with wooden frame 80 x 60 cm	69920						
	 4 Wooden legs	69968	69969	69970	69971	69972	69973	69974
	 2 Wooden legs & 2 Wooden legs With Casters	—	—	69977	69978	69979	69980	69981

● Please Select
Legs / Rails Colours

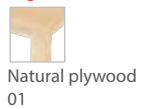

● Please Select
Table - Top Colours

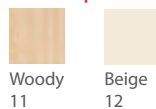

Harmony Line

Trapezoidal Elegance Table





120 x 52 cm



Table combination

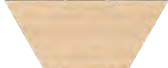
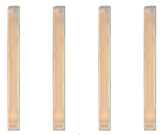

● Please Select

Complete table	Table Component	C01	C02	C0	C1	C2	C3	C4	
  Trapezoidal Table 120 x 52 cm	 Table -Top with wooden frame 120 x 52 cm	69926							
	 4 Wooden legs	69968	69969	69970	69971	69972	69973	69974	
	 2 Wooden legs & 2 Wooden legs With Casters	—	—	69977	69978	69979	69980	69981	

● Please Select
Legs / Rails Colours

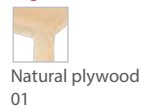

● Please Select
Table - Top Colours

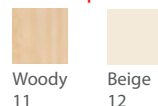

U-Shape Elegance Table





180 x 120 cm



Table combination

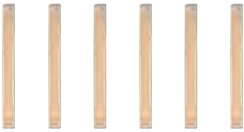

● Please Select

Complete table	Table Component	C01	C02	C0	C1	C2	C3	C4
  U-Shape Table 180 x 120 cm	 Table -Top with wooden frame 180 x 120 cm	69927						
	 6 Wooden legs	69968	69969	69970	69971	69972	69973	69974
	 4 Wooden legs & 2 Wooden legs With Casters	—	—	69977	69978	69979	69980	69981

● Please Select
Legs / Rails Colours



● Please Select
Table - Top Colours

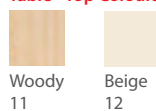





Harmony Line

Circular Elegance Table

ø 90 cm

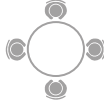

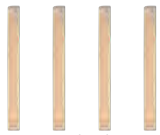
● Please Select

Complete table	Table Component	C01	C02	C0	C1	C2	C3	C4	
  Circular Table ø 90 cm	 Table -Top with wooden frame ø 90 cm	69923							
	 4 Wooden legs	—	—	69970	69971	69972	69973	69974	
	 2 Wooden legs & 2 Wooden legs With Casters	—	—	69977	69978	69979	69980	69981	

● Please Select
Legs / Rails Colours



Natural plywood
01

● Please Select
Table - Top Colours



Woody
11







Beige
12

Circular Elegance Table

Ø 120 cm

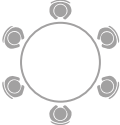

● Please Select

Complete table	Table Component	C01	C02	C0	C1	C2	C3	C4
  Circular Table Ø 120 cm	 Table -Top with wooden frame Ø 120 cm	69922						
	 4 Wooden legs	69968	69969	69970	69971	69972	69973	69974
	 2 Wooden legs & 2 Wooden legs With Casters	—	—	69977	69978	69979	69980	69981

● Please Select
Legs / Rails Colours



● Please Select
Table - Top Colours

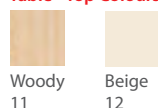

Harmony Line

Smi-Circular Elegance Table

120 x 60 cm

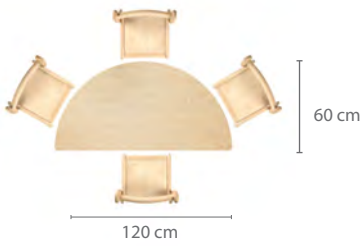



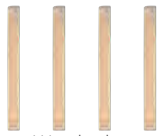



Table combination



● Please Select

Complete table	Table Component	C01	C02	C0	C1	C2	C3	C4
  Smi-Circular Table 120 x 60 cm	 Table -Top with wooden frame 120 x 60 cm	69924						
	 4 Wooden legs	—	—	69970	69971	69972	69973	69974
	 2 Wooden legs & 2 Wooden legs With Casters	—	—	69977	69978	69979	69980	69981

● Please Select
Legs / Rails Colours

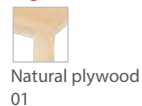

● Please Select
Table - Top Colours

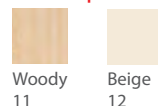

Triangle Elegance Table





120 x 60 cm



Table combination



● Please Select

Complete table	Table Component	C01	C02	C0	C1	C2	C3	C4
  Triangle Table 120 x 60 cm	 Table -Top with wooden frame 120 x 60 cm	69925						
	 3 Wooden legs	—	—	69970	69971	69972	69973	69974
	 1 Wooden legs & 2 Wooden legs With Casters	—	—	69977	69978	69979	69980	69981

● Please Select
Legs / Rails Colours

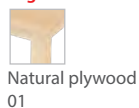

● Please Select
Table - Top Colours

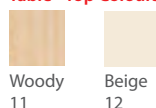

Harmony Line

Square Elegance Table

80 x 80 cm

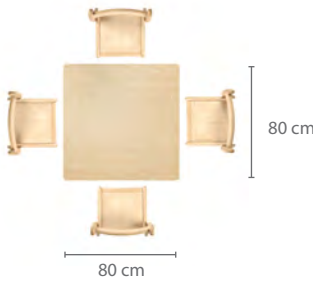

Table combination



● Please Select

Complete table	Table Component	C01	C02	C0	C1	C2	C3	C4
  Square Table 80 x 80 cm	 Table -Top with wooden frame 80 x 80 cm	69928						
	 4 Wooden legs	—	—	69970	69971	69972	69973	69974
	 2 Wooden legs & 2 Wooden legs With Casters	—	—	69977	69978	69979	69980	69981

● Please Select
Legs / Rails Colours

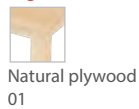

● Please Select
Table - Top Colours

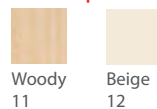

Square Elegance Table





60 x 60 cm



Table combination

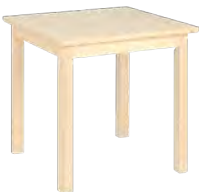

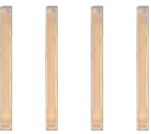
● Please Select

Complete table	Table Component	C01	C02	C0	C1	C2	C3	C4
  Square Table 60 x 60 cm	 Table -Top with wooden frame 60 x 60 cm	69929						
	 4 Wooden legs	69968	69969	69970	69971	69972	69973	69974
	 2 Wooden legs & 2 Wooden legs With Casters	—	—	69977	69978	69979	69980	69981

● Please Select
Legs / Rails Colours

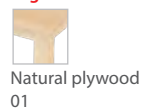

● Please Select
Table - Top Colours

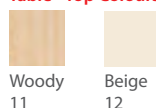

Harmony Line

Deluxe Chair

An ergonomic chair that will last for generations. Each chair is made of solid, top-quality lacquered beechwood and plywood. There are five different heights to be suitable for different aged children. Can be stacked for saving space. Available with arms.



Ergonomic seat



Ergonomic backrest



Arm



Soft Edges

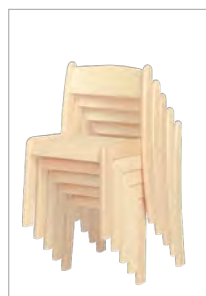

Stackable up to 5



Protective Glides



Chairs & Tables	Seats Size	Chairs Code	Recommended Tables Height
C0	21 x 22.5 cm - H. 21 cm	43304	40 cm
C1	24 x 25 cm - H. 26 cm	43303	46 cm
C2	28 x 28 cm - H. 31 cm	43302	53 cm
C3	32 x 32 cm - H. 35 cm	43301	59 cm
C4	34 x 34 cm - H. 38 cm	43300	64 cm



Seat & back colours with wooden frame



Chairs & Tables	Seats Size	Chairs Code	Recommended Tables Height
C0	21 x 22.5 cm - H. 21 cm	43305	40 cm
C1	24 x 25 cm - H. 26 cm	43306	46 cm
C2	28 x 28 cm - H. 31 cm	43307	53 cm
C3	32 x 32 cm - H. 35 cm	43308	59 cm
C4	34 x 34 cm - H. 38 c	43309	64 cm



with separated arm rest

Seat & back colours with wooden frame



How to order

Chair Code - Chair Seat & back colours with wooden frame Code **43270 - 07 - 01**

Harmony Line

Elegance Chair

These beautifully crafted stackable chairs would look great in any classroom. Each chair is made of solid, top-quality lacquered beechwood and is built to last. Five convenient seat heights are available to correspond with our Elegance tables. Available with arms.



Ergonomic seat



Ergonomic backrest

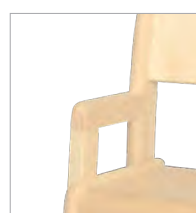

Arm



Soft Edges

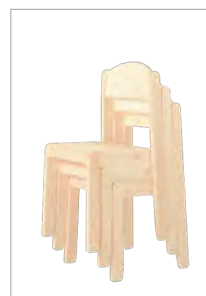

Stackable up to 5



Protective Glides



Chairs & Tables	Seats Size	Chairs Code	Recommended Tables Height
C0	21 x 22.5 cm - H. 21 cm	43201	40 cm
C1	24 x 25 cm - H. 26 cm	43202	46 cm
C2	28 x 28 cm - H. 31 cm	43203	53 cm
C3	32 x 32 cm - H. 35 cm	43204	59 cm
C4	34 x 34 cm - H. 38 cm	43205	64 cm



Seat & back colours with wooden frame



Chairs & Tables	Seats Size	Chairs Code	Recommended Tables Height
C0	21 x 22.5 cm - H. 21 cm	43206	40 cm
C1	24 x 25 cm - H. 26 cm	43207	46 cm
C2	28 x 28 cm - H. 31 cm	43208	53 cm
C3	32 x 32 cm - H. 35 cm	43209	59 cm
C4	34 x 34 cm - H. 38 cm	43210	64 cm



with separated arm rest

Seat & back colours with wooden frame

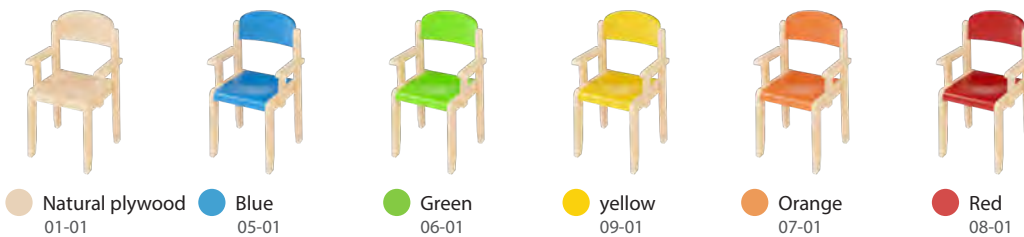

How to order

Chair Code - Chair Seat & back colours with wooden frame Code **43270 - 07 - 01**

Harmony Line

Recommended Chairs



Woody Chair

These chairs are perfect companions to our wooden student desks (Elegance - Classic). Chairs have ergonomic designs and provide proper back support. Children can easily move these light chairs around. Seats are available in 5 sizes.

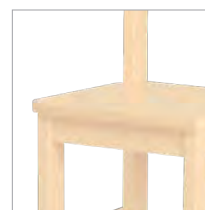

Massive beech curved seat

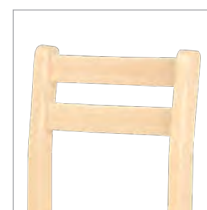

Curved top & mid rail
Ergonomic backrest



Soft Edges



Protective Glides

Chairs & Tables	Seats Size	Chairs Code	Recommended Tables Height
C0	21 x 22.5 cm - H. 21 cm	43213	40 cm
C1	24 x 25 cm - H. 26 cm	43214	46 cm
C2	28 x 28 cm - H. 31 cm	43215	53 cm
C3	32 x 32 cm - H. 35 cm	43216	59 cm
C4	34 x 34 cm - H. 38 cm	48101	64 cm



Star Chair

The Star Chair boasts an ultra-modern design, manufactured with a high quality beechwood frame. Ergonomically shaped back and seat give maximum comfort and ease of use. Seats are available in 3 sizes.



Massive beech curved seat



Comfort birch plywood backrest



Soft Edges



Protective Glides



Chairs & Tables	Seats Size	Chairs Code	Recommended Tables Height
C2	28 x 28 cm - H. 31 cm	48120	53 cm
C3	32 x 32 cm - H. 35 cm	48121	59 cm
C4	34 x 34 cm - H. 38 cm	48125	64 cm



How to order

Chair Code - Chair Seat & back colours with wooden frame Code **43270 - 01 - 01**

Harmony Line

Recommended Chairs



Classic S Chair

This chair combines all the advantages of the classic chair in addition to stacking. It is a top quality, colourful chair that will last for generations. The frame is made of solid beechwood and the seat is made from coloured laminated MDF boards. This durable chair can easily bear the weight of an adult to stand on. Leg-tips have plastic caps to prevent noise and marring of floor surfaces when moved.

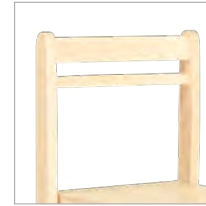

Curved backrest



Birch Plywood seat



Stackable up to 5



Soft Edges



Protective Glides

Chairs & Tables	Seats Size	Chairs Code	Recommended Tables Height
C0	21 x 22.5 cm - H. 21 cm	43140	40 cm
C1	24 x 25 cm - H. 26 cm	43141	46 cm
C2	28 x 28 cm - H. 31 cm	43142	53 cm
C3	32 x 32 cm - H. 35 cm	43143	59 cm
C4	34 x 34 cm - H. 38 cm	43144	64 cm



Seat & back colours with wooden frame



● Natural plywood
01-01

● Blue
05-01

● Green
06-01

● yellow
09-01

● Orange
07-01

● Red
08-01

Classic Plus Chair

Natural beechwood with HQ finishes, this very light and sturdy design offers durability and ease of movement. The colourful birch plywood seats are available in 4 colours.



Birch Plywood seat



Curved backrest



Soft Edges



Protective Glides



Chairs & Tables	Seats Size	Chairs Code	Recommended Tables Height
C0	21 x 22.5 cm - H. 21 cm	43120	40 cm
C1	24 x 25 cm - H. 26 cm	43121	46 cm
C2	28 x 28 cm - H. 31 cm	43122	53 cm
C3	32 x 32 cm - H. 35 cm	43123	59 cm
C4	34 x 34 cm - H. 38 cm	43124	64 cm

Seat & back colours with wooden frame



● Natural plywood
01-01



● Blue
05-01



● Green
06-01



● yellow
09-01



● Orange
07-01



● Red
08-01

How to order

Chair Code - Chair Seat & back colours with wooden frame Code **43270 - 07 - 01**

Harmony Line

Recommended Chairs

Classic Chair

Top quality, colourful chairs that will last for generations. These Classic chairs are made with a solid beech wooden frame, strong enough for even an adult to stand on. Seats are coloured laminated MDF board.



Curved backrest



Birch Plywood seat



Soft Edges



Protective Glides

Chairs & Tables	Seats Size	Chairs Code	Recommended Tables Height
C0	21 x 22.5 cm - H. 21 cm	43115	40 cm
C1	24 x 25 cm - H. 26 cm	43116	46 cm
C2	28 x 28 cm - H. 31 cm	43117	53 cm
C3	32 x 32 cm - H. 35 cm	43118	59 cm
C4	34 x 34 cm - H. 38 cm	43119	64 cm



Seat & back colours with wooden frame



● Natural plywood
01-01

● Blue
05-01

● Green
06-01

● yellow
09-01

● Orange
07-01

● Red
08-01



Harmony Line

Classroom **Fit Outs**

We offer custom designed room plans to fit your needs. We have a team of experts to translate your vision into functional yet inspirational learning spaces. Here are some ideas for how you can use our Harmony Line furniture pieces to create integrated kindergarten classrooms.





PrimeLine

Metal tube frame & birch plywood seat & backrest.

The Metal Framed Series.

Ergonomically rigged mMetal tubes cChairs and table frames. Natural bBirch pPlywood seat and back rest.

Using our prime line range helps you create an evolving learning space for children to grow and develop confidently in. Durable wooden tables and chairs with metal frames ensure years of durability. Modular and ergonomically designed for years of safe and efficient kindergarten furniture. The wide range of colours available gives you the flexibility to create many classroom outfits that satisfy all tastes.



Tables:

Tops made from:

- 22 mm thick MDF (Medium Density Fibreboard), laminated with HPL (high pressure laminate)
- Tabletops are available in wood grain and beige colour, with high scratch and shock resistant surfaces.
- Newly designed solid wood edges are curved and rounded for safety. No grooves when tables are grouped together or combined.



Table frame made from:

- Table frame and legs are made from rigged welded metal tubes, with strong scratch resistance with electrostatic powder coating.
- Metal lLegs are fitted with glides to protect floors, provide floor leveling and reduce noise.
 - Table fFrame comes assembled. Tabletops are easily fixed to the metal frame using threaded metal insert and screws.



- 5 years gGuarantee.

Chairs

Frame made from rigged metal tubes with strong scratch- resistantce epoxy paints.

- Seat and back rest made from ergonomically curved, multi layered Birch Plywood.
- Special leg design provides stability
- Metal frames are fitted with glides to protect floors and reduce noise.
- Multi stack cChairs.
- Comes assembled.
- Wide range of natural look and colours range

available (for chair frame, and for seats and back rest). Very sStrong and can hold the weight of an adult.

- 5 years gGuarantee.

Prime Line

We suggest the Ultra Table with Simple Chair as the main choice in the prime line. Any wooden chair with metal frame - from our collection - can also be used with our Ultra Table (page 44 to 45).



● Ultra Table



● Simple Chair



Table combination



Another shapes of Ultra Tables



Legs / Rails Colours

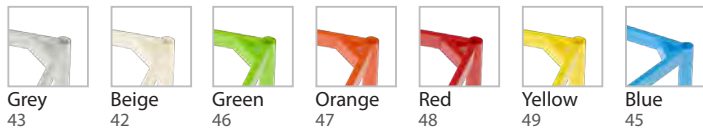
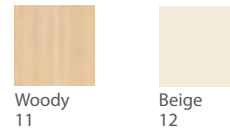
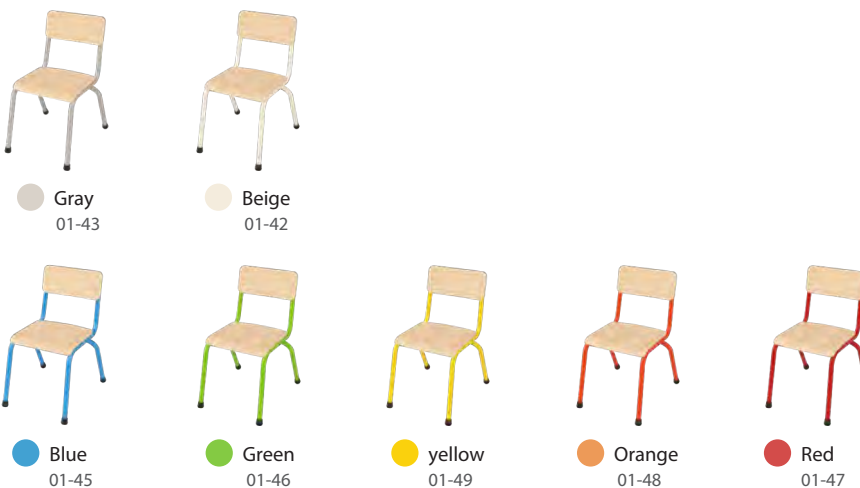

Table - Top Colours



wooden seat & back with colored metal frame



Seat & back colours with grey metal frame



Prime Line

Ultra Tables

This range offers durable tables with metal frame and two options of laminated tabletop with natural edge colour. The plastic glides are for soft and hard floors. Castors are available on one side for easy moving.



22mm MDF Laminated HPL solid beech edges

Tabletops 22mm thickness are made from extremely strong medium density fibreboard (MDF) insulation, which is stiff, has no knots and has fine edges. The tops are also laminated with high pressure lamination HPL (under heat [80-90 Celsius] and pressure [250 kgs/m²]). No added formaldehyde (NAF). Ivory colour or beige wood theme. Edges made from solid beechwood painted with protective varnish, with safe and gently and rounded edges.



A Special rounded Edge design without spacing when tables are grouped (shark nose Edges)



Easy to clean

HPL VS. MELAMINE

maximum durability. High Pressure Laminate is commonly referred to as HPL and is manufactured under 1000kg per square-metre of pressure pressing down on 6 to 8 layers of kraft paper bonded with phenolic resin glue, then topped by a polymer facing. Applications include benchtops, joinery, wall panelling, lockers, and tables where scuff resistance is important.

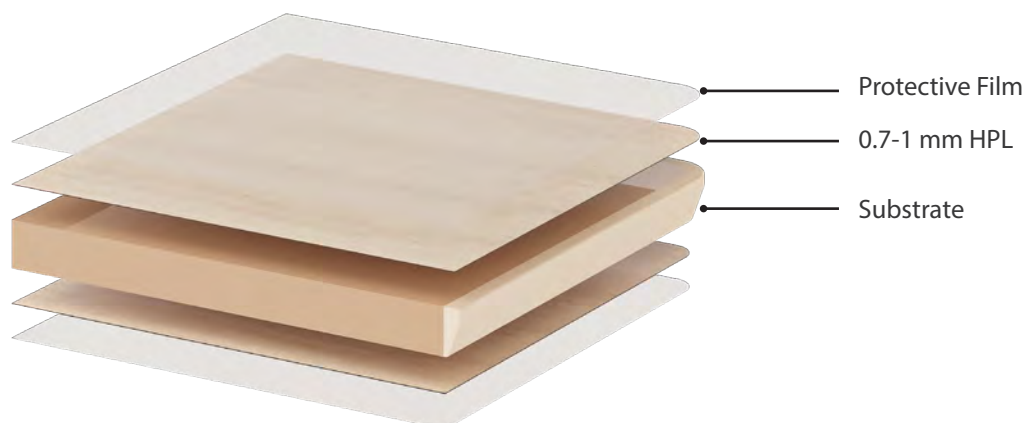

When you purchase HPL sheets, it is generally not attached to a substrate such as MDF or craft wood. Attaching it to a timber substrate is an entirely separate process that is commonly referred to as "laying up the laminate". It should be attached to a dense substrate (base wood layer) for best results. We use moisture resistant Medium Density Fibreboard (MDF) as the substrate and ABET High-Pressure Laminates as the decorative surface. This results in the best possible finish with maximum durability.

Prime Line

Metal Legs / Rails

There are five different heights for these metal legs, which is convenient to children of different heights. These tables come packed flat for your convenience. The tables are easily assembled with the simple instructions provided.

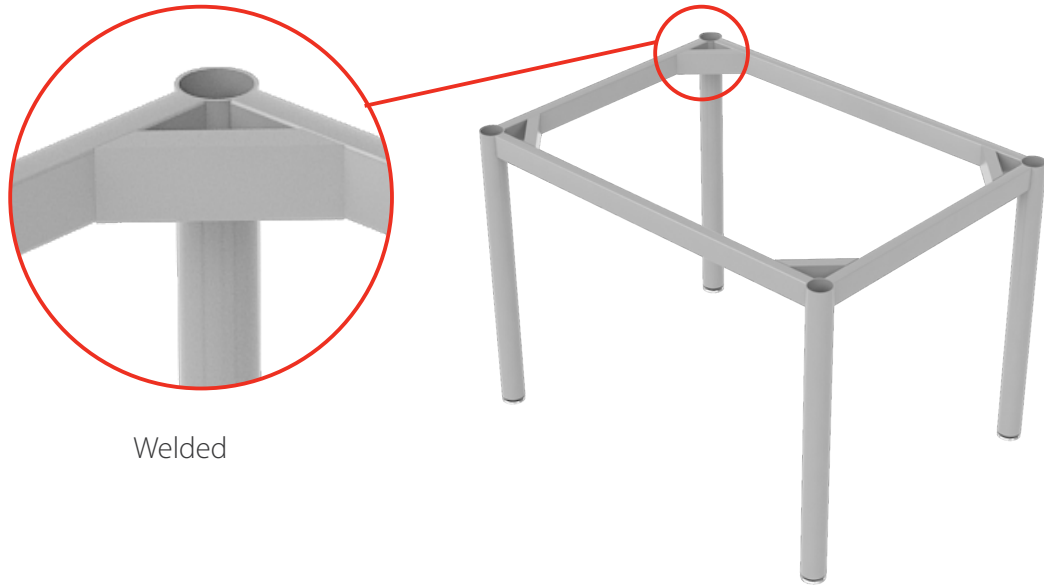

Available with or without Lockable Casters



Electrostatic



Adjustable P.P glide

Table Heights

- C4 64 cm
- C3 59 cm
- C2 53 cm
- C1 46 cm
- C0 40 cm
- C01 36 cm
- C02 30 cm

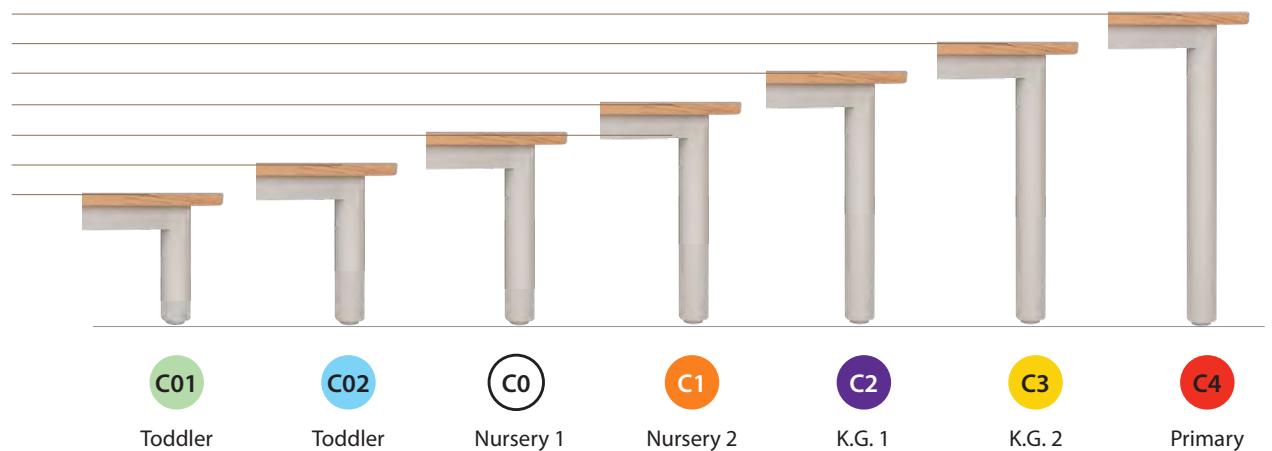



Prime Line

Rectangular Ultra Table



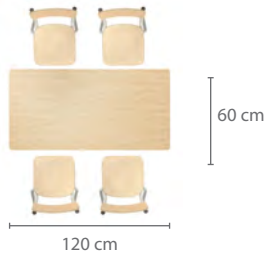

120 x 60 cm



| Table combination



● Please Select

Complete table	Table Component	C01	C02	C0	C1	C2	C3	C4
  Rectangular Table 120 x 60 cm  Table -Top 120 x 60 cm	 Metal Frame	00000	00000	44530	44532	44621	44626	44534
	 Metal Frame With Casters	—	—	44531	44533	44640	44645	44535

● Please Select

Legs / Rails Colours

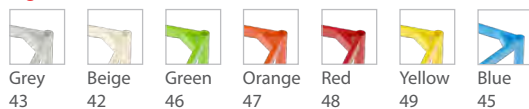

● Please Select

Table - Top Colours



Rectangular Ultra Table

80 x 60 cm

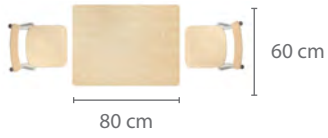
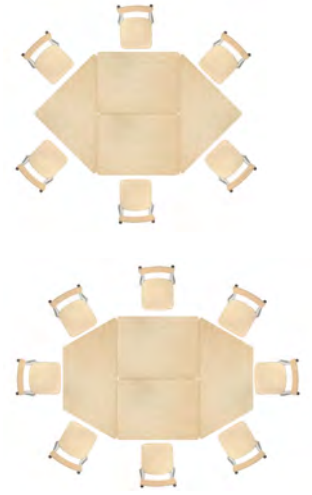







Table combination



● Please Select

Complete table	Table Component	C01	C02	C0	C1	C2	C3	C4
  <p>Rectangular Table 80 x 60 cm</p>  <p>Table -Top 80 x 60 cm</p>	 <p>Metal Frame</p>	00000	00000	47920	47921	47922	47923	47924
	 <p>Metal Frame With Casters</p>	—	—	47950	47951	47952	47953	47954

● Please Select

Legs / Rails Colours

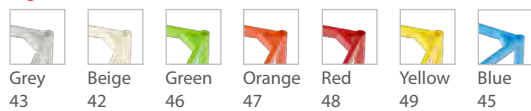

● Please Select

Table - Top Colours

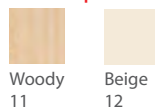





Prime Line

Circular Ultra Table

ø 90 cm



● Please Select

Complete table	Table Component	C01	C02	C0	C1	C2	C3	C4
  Circle Table ø 90 cm  Table -Top ø 90 cm	 Metal Frame	00000	00000	47926	47927	47928	47929	47930
	 Metal Frame With Casters	—	—	47955	47956	47957	47958	47959

● Please Select

Legs / Rails Colours

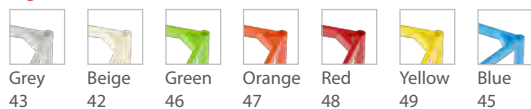

● Please Select

Table - Top Colours

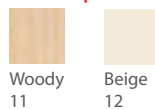





Circular Ultra Table

ø 120 cm

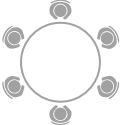

● Please Select

Complete table	Table Component	C01	C02	C0	C1	C2	C3	C4
  Circle Table ø 120 cm  Table -Top ø 120 cm	 Metal Frame	00000	00000	44542	44544	44625	44630	44546
	 Metal Frame With Casters	—	—	44543	44545	44643	44648	44547

● Please Select

Legs / Rails Colours

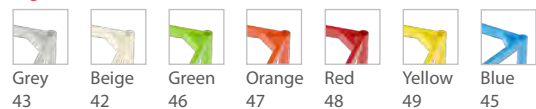

● Please Select

Table - Top Colours

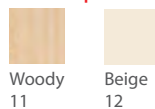

Prime Line

Smi-Circular Ultra Table

120 x 60 cm

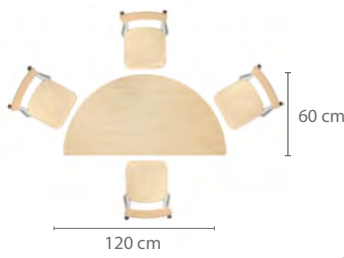







Table combination



● Please Select

Complete table	Table Component	C01	C02	C0	C1	C2	C3	C4
  Smi-Circular Table 120 x 60 cm  Table -Top 120 x 60 cm	 Metal Frame	00000	00000	44536	44538	44624	44629	44540
	 Metal Frame With Casters	—	—	44537	44539	44642	44647	44541

● Please Select

Legs / Rails Colours

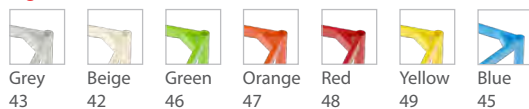

● Please Select

Table - Top Colours



Triangle Ultra Table

120 x 60 cm

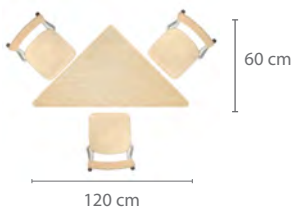







Table combination



● Please Select

Complete table	Table Component	C01	C02	C0	C1	C2	C3	C4
  Triangle Table 120 x 60 cm  Table -Top 120 x 60 cm	 Metal Frame	00000	00000	44560	44562	44631	44632	44564
	 Metal Frame With Casters	—	—	44561	44563	44635	44636	44565

● Please Select

Legs / Rails Colours

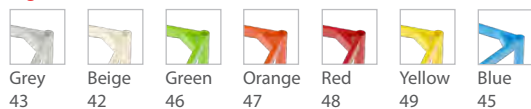

● Please Select

Table -Top Colours



Prime Line

Square Ultra Table 80 x 80 cm

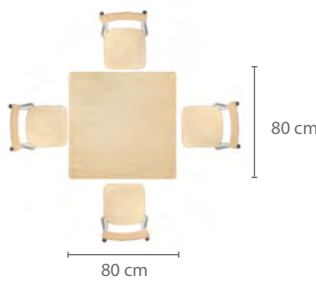
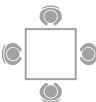





Table combination



● Please Select

Complete table	Table Component	C01	C02	C0	C1	C2	C3	C4
  Square Table 80 x 80 cm  Table - Top 80 x 80 cm	 Metal Frame	00000	00000	44650	44651	44652	44653	44654
	 Metal Frame With Casters	—	—	44655	44656	44657	44658	44659

● Please Select

Legs / Rails Colours

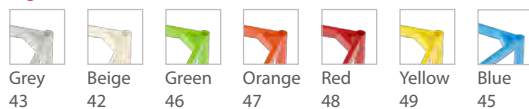

● Please Select

Table - Top Colours



Square Ultra Table





60 x 60 cm



Table combination



● Please Select

Complete table	Table Component	C01	C02	C0	C1	C2	C3	C4
  <p>Square Table 60 x 60 cm</p>  <p>Table -Top 60 x 60 cm</p>	 <p>Metal Frame</p>	00000	00000	44611	44612	44613	44614	44615
	 <p>Metal Frame With Casters</p>	—	—	44616	44617	44618	44619	44620

● Please Select

Legs / Rails Colours

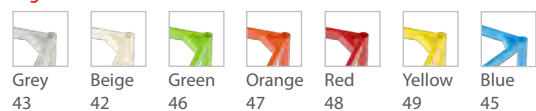

● Please Select

Table -Top Colours

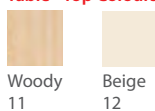

Prime Line

Trapezoidal Ultra Table 120 x 52 cm



Table combination

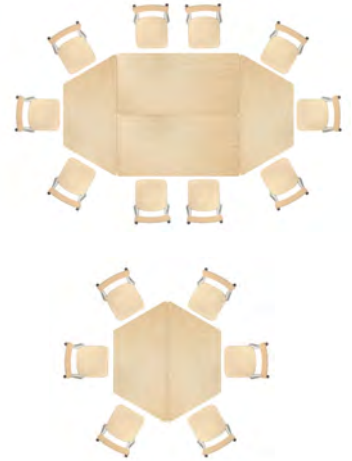

● Please Select

Complete table	Table Component	C01	C02	C0	C1	C2	C3	C4
 Trapezoidal Table 120 x 52 cm Table -Top 120 x 52 cm	 Metal Frame	00000	00000	44548	44550	44623	44628	44552
	 Metal Frame With Casters	—	—	44549	44551	44641	44646	44553

● Please Select

Legs / Rails Colours

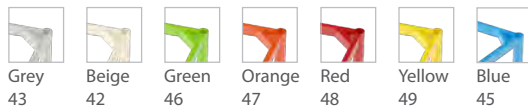

● Please Select

Table - Top Colours

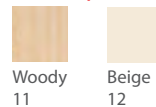



Prime Line

Simple Chair

Sturdy, durable and light chairs. Chairs are constructed with superior formed metal pipes, seat and back from environmental-friendly plywood for comfortable seating. Available in seven metal frame colours. Chairs are stackable or can be put on tabletops, allowing easy classroom cleaning.



Curved Birch plywood seat & backrest



Plastic Cap



Stackable up to 5



Chairs & Tables	Chairs Size	Chairs Code	Recommended Tables Height
C0	21 x 22.5 cm - H. 21 cm	48423	40 cm
C1	24 x 25 cm - H. 26 cm	48424	46 cm
C2	28 x 28 cm - H. 31 cm	43505	53 cm
C3	32 x 32 cm - H. 35 cm	43506	59 cm
C4	34 x 34 cm - H. 38 cm	48425	64 cm



Chairs - Metal Frame Colours



Gray
01-43



Beige
01-42



Blue
01-45



Green
01-46



yellow
01-49



Orange
01-48



Red
01-47

Seat & back colours with grey metal frame



Blue
15-43



Green
16-43



yellow
19-43



Orange
17-43



Red
18-43



Prime Line

Recommended Chairs



Dynamic Chair

Sturdy, durable and light chair. Constructed with superior formed metal pipes. Ergonomically designed back and seat to increase seating comfort. Seat and back surface are made from environmentally friendly plywood for comfort seating. The design of the legs make them stackable for easy storage.



Curved Birch plywood seat & backrest



Stackable up to 5



Plastic Glides

Chairs & Tables	Chairs Size	Chairs Code	Recommended Tables Height
C2	28 x 28 cm - H. 31 cm	43502	53 cm
C3	32 x 32 cm - H. 35 cm	43503	59 cm
C4	34 x 34 cm - H. 38 cm	48165	64 cm



Metal Frame Colours



Gray
01-43



Beige
01-42



Red
01-48



Orange
01-47



Yellow
01-49



Green
01-46



Blue
01-45

Seat & back rest Colours



Red
18-43



Orange
17-43



Yellow
19-43



Green
16-43



Blue
15-43

Action Chair

Modern and ergonomically designed back and seat to increase seating comfort. The environmentally friendly plywood seat surface resists scratches and is easy to clean. Glides guarantee stability and minimum abrasion on all types of floors. The design of the legs makes them stackable for easy storage.



Stackable up to 5



Plastic Glides



Curved Birch plywood seat & backrest



Chairs & Tables	Chairs Size	Chairs Code	Recommended Tables Height
C2	28 x 28 cm - H. 31 cm	43507	53 cm
C3	32 x 32 cm - H. 35 cm	43508	59 cm
C4	34 x 34 cm - H. 38 cm	48325	64 cm

Metal Frame Colours

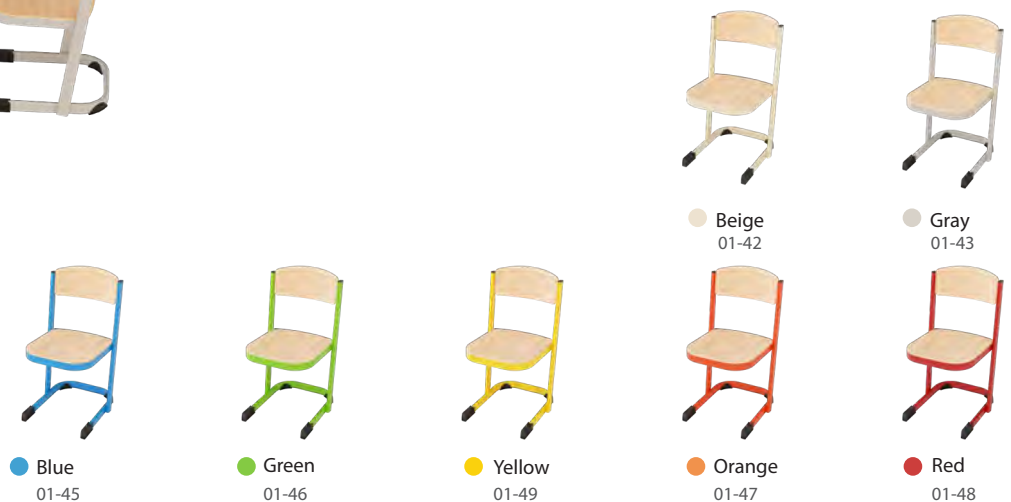

Seat & back rest Colours



Prime Line

Classroom **Fit Outs**

We offer custom designed room plans to fit your needs. We have a team of experts to translate your vision into functional yet inspirational learning spaces. Here are some ideas for how you can use our Harmony Line furniture pieces to create integrated kindergarten classrooms.

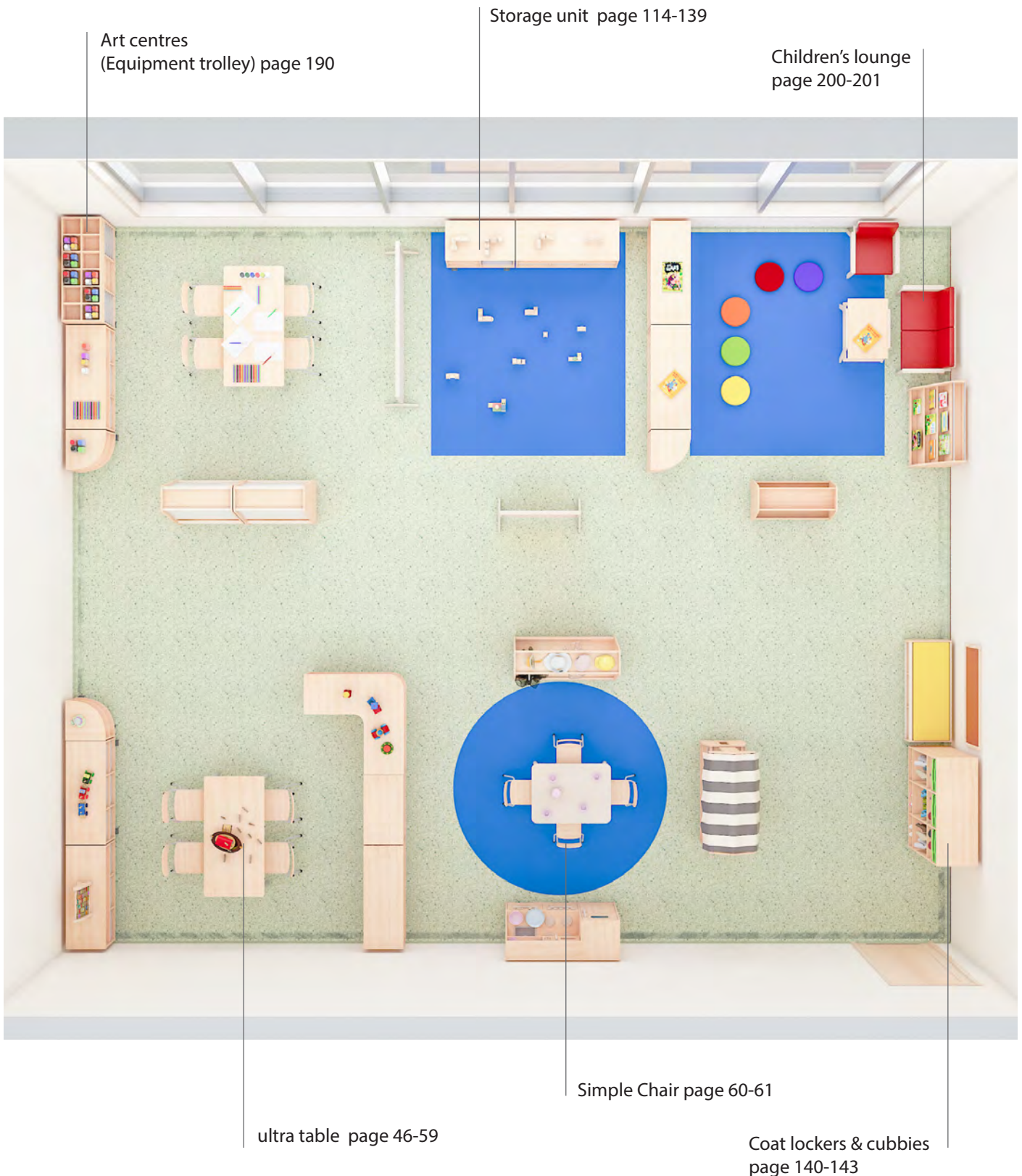



GrandLine

The Metal / Wood Series

New uUnique design of multi adjustable metal/ wooden table legs. Rigged mMetal tubes. Chairs frames with natural birch plywood seat and back rest.

Grand line is the ideal choice for encouraging creativity and cooperation among children. The construction and materials used ensures that they will remain durable in their everyday use. The wide range of colours available gives you the flexibility to create many classroom outfits that satisfy all tastes. It is ergonomically designed for active children in their early years to gently encourage healthy posture. The modular designs offer infinite arrangements, and infinite possibilities.



Tables:

Tops made from:

- 22 mm thick MDF (Medium Density Fibreboard), laminated with HPL (high pressure laminate)
- Tabletops are available in wood grain and beige colour, with high scratch and shock resistant surfaces.
- Newly designed solid wood edges are curved and rounded for safety. No grooves when tables are grouped together or combined.



Table legs made from:

- Adjustable mMetal/ wood table legs, with newly designed construction.
- Table legs made from unique easily adjustable varnished solid beech wood, with strong anti-scratch epoxy paint finish steel base.
- Legs are fitted with glides to protect floors; floor leveling and reduce noise.
- Legs come separate and can fit to any tabletop size and design. They are easy and quick to assemble and fix using metal



- threaded insert and screws.
- Table tops legs are adjustable up to 5 heights.
- 5 years gGuarantee.

Chairs

- Frame made from rigged metal tubes with strong scratch-resistant epoxy paints.
- Seat and backrest made from ergonomically curved multi-layered birch plywood.
- Special leg design provides stability.
- Metal frames are fitted with glides to protect floors and reduce noise.

- Multi stack chairs.
- Comes assembled.
- Wide range of colours available (for chair frame, seat and backrest).
- Very strong and can hold the weight of an adult.
- 5 years guarantee.

Grand Line

We suggest the Flexo Table with Simple Chair as the main choice in the Grand line. Any wooden chair with metal frame - from our collection - can also be used with our Flexo Table. (pPage 58 to 59).



● Flexo Table



● Simple Chair



Table combination



Another shapes of Ultra Tables



Legs / Rails Colours

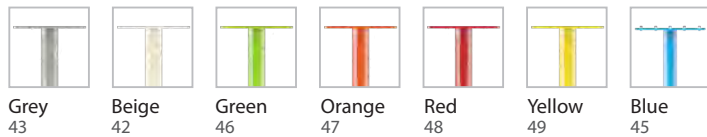
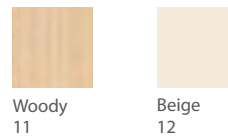
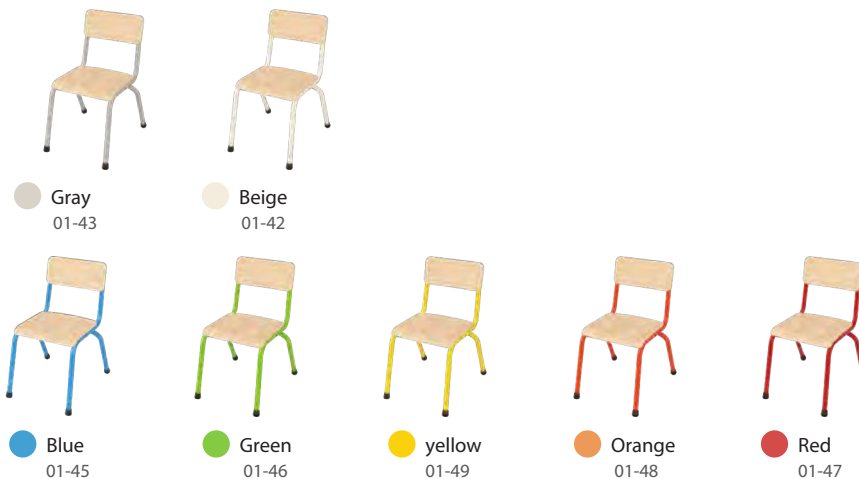

Table - Top Colours



wooden seat & back with colored metal frame



Seat & back colours with grey metal frame



Grand Line

Flexo Tables

These flexible movable creative tables combine contemporary looks and, functionality, as well as flexibility and that encourages social behaviour, creativity and cooperation among students. It comes in a variety of unique shapes and sizes. Each shape and size has its merits and benefits, depending on the learning situation. Tables can be combined with each other or with other tables, combining a multitude of layouts to create an attractive look. Tables are made of medium-density fibreboard (MDF) covered by high-pressure laminate (HPL). Legs are either fixed or adjustable to offer different heights, an advantage for mixed-age groups.

As everyone has his/her own choices, we have enabled you to choose your table just as you like! Choose the table-top material and then decide if you want a fixed or adjustable leg. Also, you can decide if you want coasters (in two legs) or glides.



Easy to clean

28mm MDF Laminated HPL solid beech edges

Tabletops 28mm thickness are made from extremely strong medium density fibreboard (MDF) insulation, which is stiff, has no knots and has fine edges. The tops are also laminated with high pressure lamination HPL (under heat [80-90 Celsius] and pressure [250 kgs/m²]). No added formaldehyde (NAF). Ivory colour or beige wood theme. Edges made from solid beechwood painted with protective varnish, with safe and gently and rounded edges. A special rounded edge design without spacing when tables are grouped (shark nose edges).



A Special rounded Edge design without spacing when tables are grouped (shark nose Edges)



As everyone has his/her own choices, we have enabled you to choose your table just as you like! Choose the table-top material and then decide if you want a fixed or adjustable leg. Also you can decide if you want coasters (in two legs) or glides.



Wood/Metal legs

These legs can be adjusted according to children of different heights. Metal adjustable legs can be used from (C0 – C4) stage. It is ideal for mixed-age classrooms.



Metal insert & Adjustable PP glide



Available with or without Lockable Casters

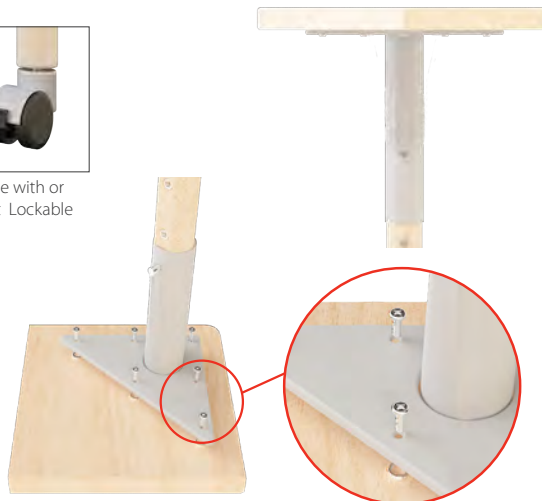

Metal insert & hex heads screws



Metal tube welded to bracket angel

Adjustable Leg Heights

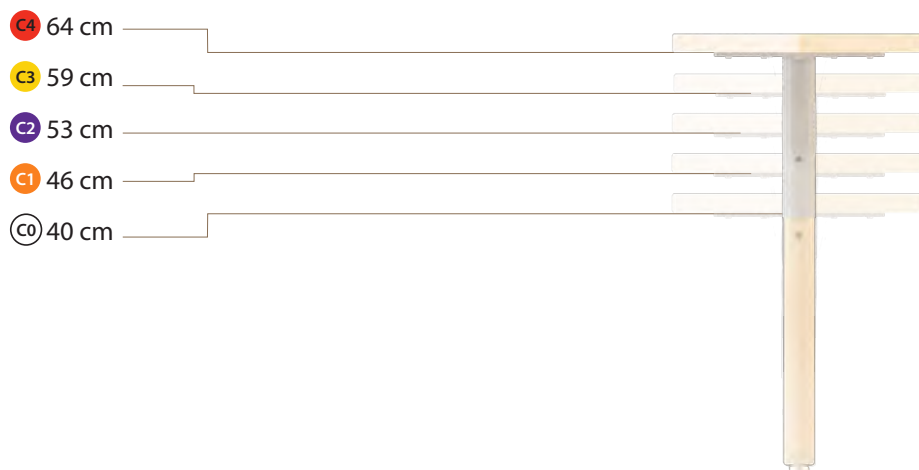

Metal legs

There are five 5 different heights for these metal legs, which is convenient to children of different heights.



Available with or without Lockable Casters



Adjustable PP glide

Available for Size **C0 to C4**



Metal insert & hex heads screws

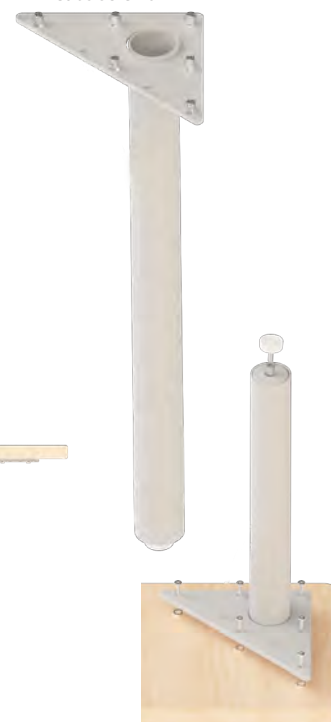

Metal tube welded to bracket angel

* Number of legs & Casters are upon table shape

Grand Line

Rectangular Flexo Table

120 x 60 cm



Table combination



● Please Select

Complete table	Table Component	C01	C02	C0	C1	C2	C3	C4
  Rectangular Table 120 x 60 cm	 Table-Top 120 x 60 cm	69942						
	 4 Metal & Wood Legs	—	—	69965				
	 2 Metal & Wood Legs & 2 Metal & Wood Legs With Casters	—	—	69966				

● Please Select

Legs / Rails Colours



● Please Select

Table - Top Colours

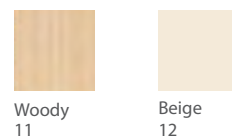

Rectangular Flexo Table

120 x 60 cm



Table combination



● Please Select

Complete table	Table Component	C01	C02	C0	C1	C2	C3	C4
  Rectangular Table 120 x 60 cm	 Table -Top 120 x 60 cm	69942						
	 4 Metal Legs	—	—	69955	69956	69957	69958	69959
	 2 Metal Legs & 2 Metal Legs With Casters	—	—	69960	69961	69962	69963	69964

● Please Select

Legs / Rails Colours

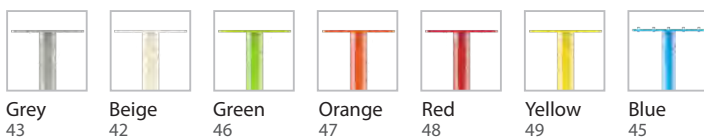

● Please Select

Table - Top Colours

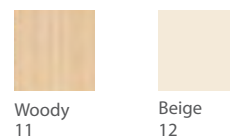

Grand Line

Semi Oblong Flexo Table

100 x 80 cm

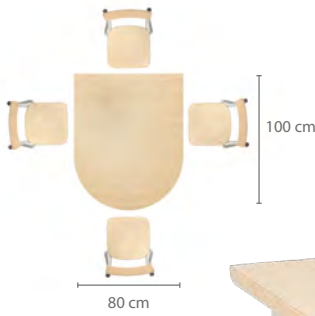

Table combination



● Please Select

Complete table	Table Component	C01	C02	C0	C1	C2	C3	C4
	 Table -Top 100 x 80 cm							
	 4 Metal & Wood Legs	—	—					69965
Semi Oblong Table 100 x 80 cm	 2 Metal & Wood Legs & 2 Metal & Wood Legs With Casters	—	—					69966

● Please Select

Legs / Rails Colours

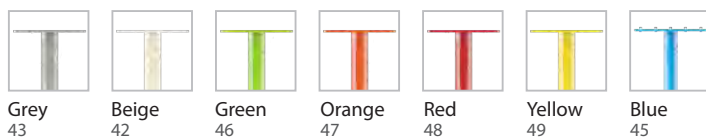

● Please Select

Table - Top Colours

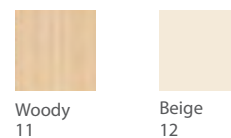

Semi Oblong Flexo Table

100 x 80 cm

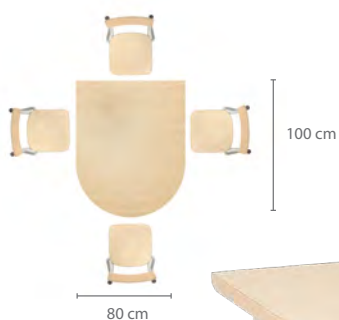

Table combination



● Please Select

Complete table	Table Component	C01	C02	C0	C1	C2	C3	C4
  Semi Oblong Table 100 x 80 cm	 Table-Top 100 x 80 cm	69949						
	 4 Metal Legs	—	—	69955	69956	69957	69958	69959
	 2 Metal Legs & 2 Metal Legs With Casters	—	—	69960	69961	69962	69963	69964

● Please Select

Legs / Rails Colours

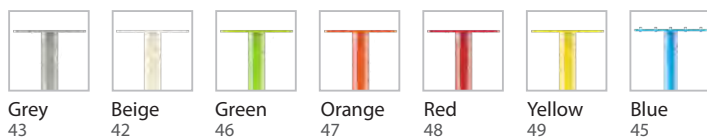

● Please Select

Table - Top Colours

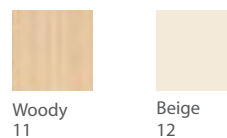

Grand Line

Square Flexo Table 80 x 80 cm

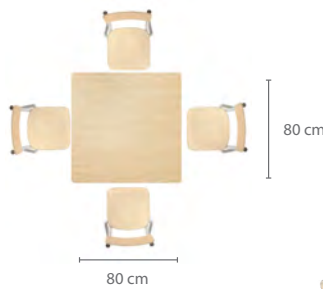
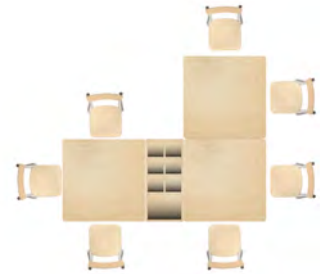

Table combination



● Please Select

Complete table	Table Component	C01	C02	C0	C1	C2	C3	C4
  Square Table 80 x 80 cm	 Table -Top 80 x 80 cm							
	 4 Metal & Wood Legs	—	—					69965
	 2 Metal & Wood Legs & 2 Metal & Wood Legs With Casters	—	—					69966

● Please Select

Legs / Rails Colours

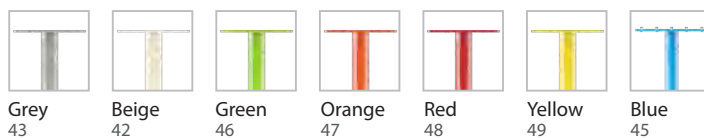

● Please Select

Table - Top Colours

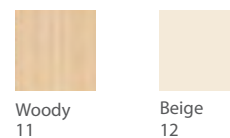

Square Flexo Table

80 x 80 cm

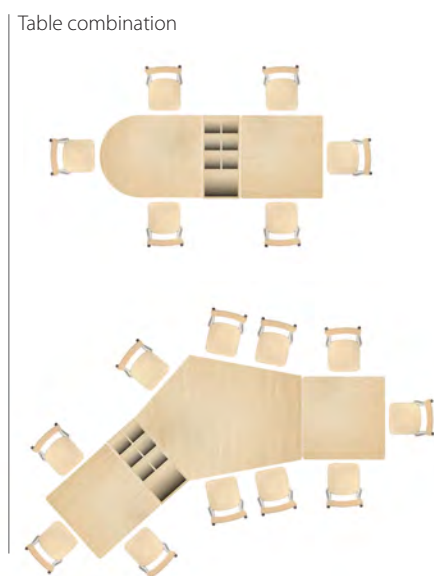
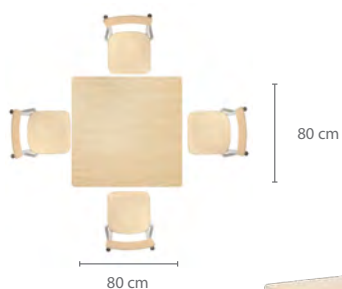

● Please Select

Complete table	Table Component	C01	C02	C0	C1	C2	C3	C4
 Square Table 80 x 80 cm	 Table -Top 80 x 80 cm	69940						
	 4 Metal Legs	—	—	69955	69956	69957	69958	69959
	 2 Metal Legs & 2 Metal Legs With Casters	—	—	69960	69961	69962	69963	69964

● Please Select

Legs / Rails Colours

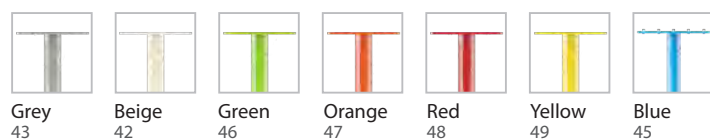

● Please Select

Table - Top Colours

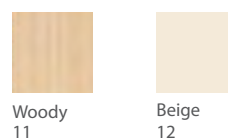

Grand Line

Square Flexo Table 60 x 60 cm



Table combination



● Please Select

Complete table	Table Component	C01	C02	C0	C1	C2	C3	C4
  Square Table 60 x 60 cm	 Table-Top 60 x 60 cm							
	 4 Metal & Wood Legs	—	—					
	 2 Metal & Wood Legs & 2 Metal & Wood Legs With Casters	—	—					

● Please Select

Legs / Rails Colours

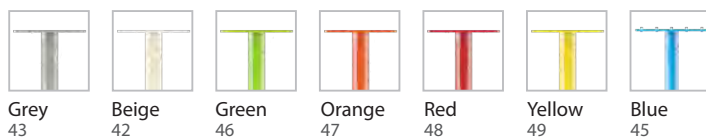

● Please Select

Table - Top Colours

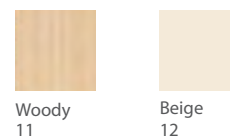

Square Flexo Table

60 x 60 cm

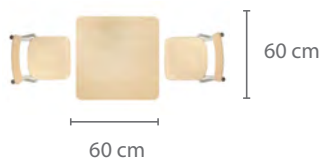







Table combination



● Please Select

Complete table	Table Component	C01	C02	C0	C1	C2	C3	C4
  Square Table 60 x 60 cm	 Table -Top 60 x 60 cm	69941						
	 4 Metal Legs	—	—	69955	69956	69957	69958	69959
	 2 Metal Legs & 2 Metal Legs With Casters	—	—	69960	69961	69962	69963	69964

● Please Select

Legs / Rails Colours

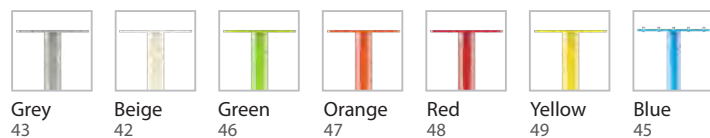

● Please Select

Table - Top Colours

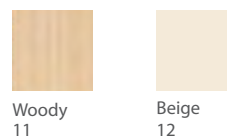

Grand Line

Large Pentagon Flexo Table

160 x 120 cm

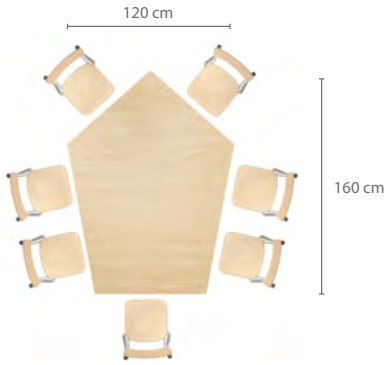







Table combination



● Please Select

Complete table	Table Component	C01	C02	C0	C1	C2	C3	C4
	 Table -Top 160 x 120 cm				69946			
	 5 Metal & Wood Legs	—	—			69965		
Large Pentagon Table 160 x 120 cm	 3 Metal & Wood Legs & 2 Metal & Wood Legs With Casters	—	—				69966	

● Please Select

Legs / Rails Colours

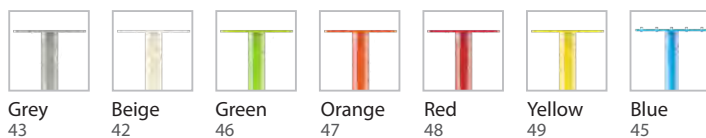

● Please Select

Table - Top Colours

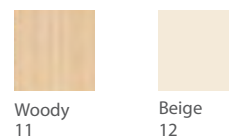



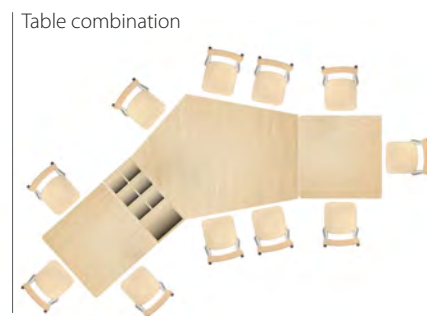
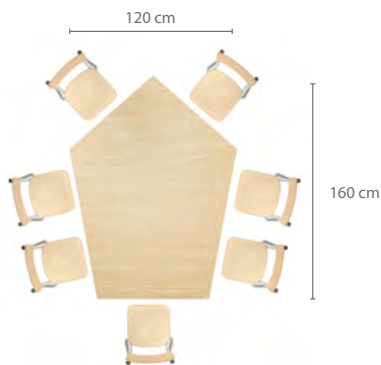

Large Pentagon Flexo Table

160 x 120 cm



● Please Select

Complete table	Table Component	C01	C02	C0	C1	C2	C3	C4
  Large Pentagon Table 160 x 120 cm	 Table -Top 160 x 120 cm	69946						
	 5 Metal Legs	—	—	69955	69956	69957	69958	69959
	 3 Metal Legs & 2 Metal Legs With Casters	—	—	69960	69961	69962	69963	69964

● Please Select

Legs / Rails Colours

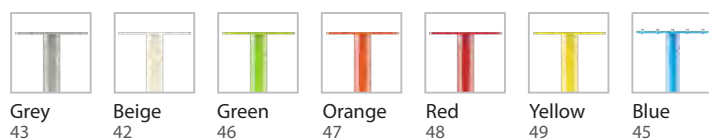

● Please Select

Table - Top Colours

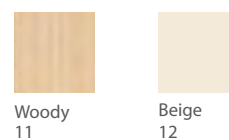

Grand Line

Small Pentagon Flexo Table

120 x 120 cm

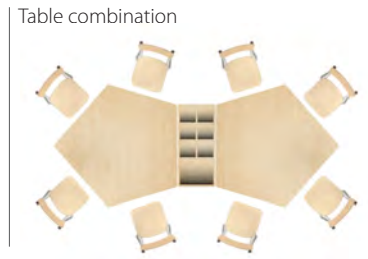

● Please Select

Complete table	Table Component	C01	C02	C0	C1	C2	C3	C4
	Table -Top 120 x 120 cm				69945			
		—	—				69965	
	5 Metal & Wood Legs							
Small Pentagon Table 120 x 120 cm		—	—				69966	
	3 Metal & Wood Legs & 2 Metal & Wood Legs With Casters							

● Please Select

Legs / Rails Colours

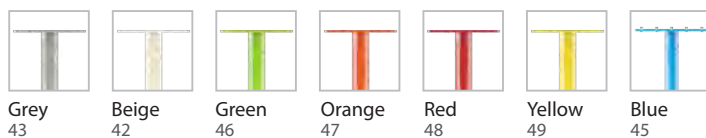

● Please Select

Table - Top Colours

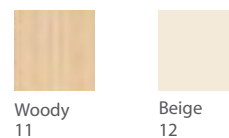



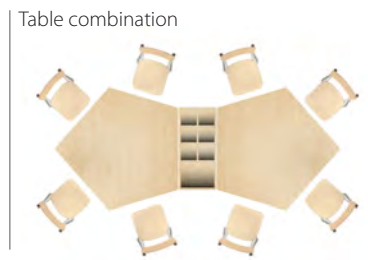

Small Pentagon Flexo Table

120 x 120 cm



● Please Select

Complete table	Table Component	C01	C02	C0	C1	C2	C3	C4
  Small Pentagon Table 120 x 120 cm	 Table -Top 120 x 120 cm	69945						
	 5 Metal Legs	—	—	69955	69956	69957	69958	69959
	 3 Metal Legs & 2 Metal Legs With Casters	—	—	69960	69961	69962	69963	69964

● Please Select

Legs / Rails Colours

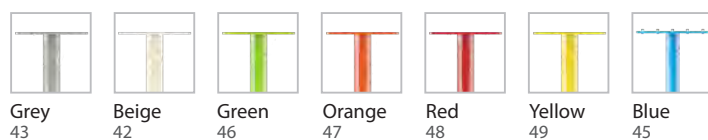

● Please Select

Table - Top Colours

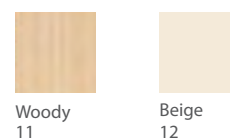

Grand Line





L-Shape Flexo Table 120 x 120 cm

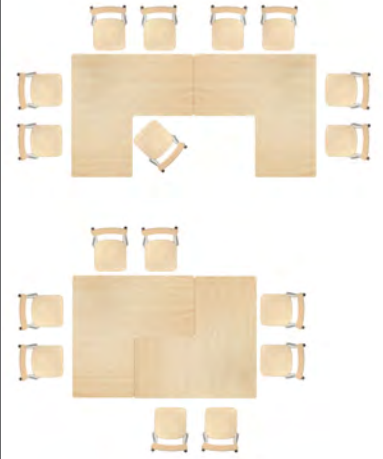

Table combination



● Please Select

Complete table	Table Component	C01	C02	C0	C1	C2	C3	C4
  L-Shape Table 120 x 120 cm	 Table -Top 120 x 120 cm							
	 5 Metal & Wood Legs	—	—					
	 3 Metal & Wood Legs & 2 Metal & Wood Legs With Casters	—	—					
					69948			
								69965
								69966

● Please Select

Legs / Rails Colours

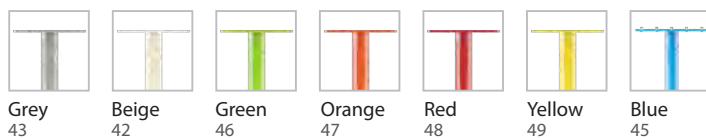

● Please Select

Table - Top Colours

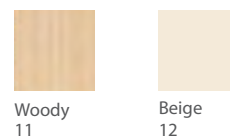

L-Shape Flexo Table

120 x 120 cm

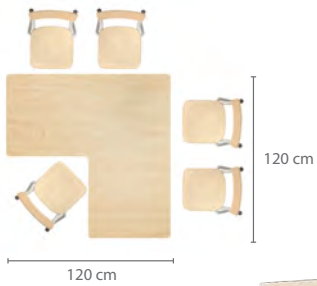
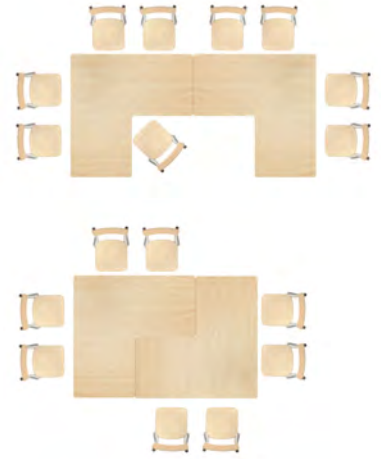







Table combination



● Please Select

Complete table	Table Component	C01	C02	C0	C1	C2	C3	C4
  L-Shape Table 120 x 120 cm	 Table -Top 120 x 120 cm	69948						
	 5 Metal Legs	—	—	69955	69956	69957	69958	69959
	 3 Metal Legs & 2 Metal Legs With Casters	—	—	69960	69961	69962	69963	69964

● Please Select

Legs / Rails Colours

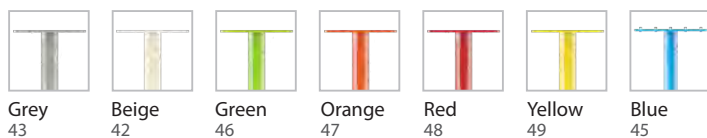

● Please Select

Table - Top Colours

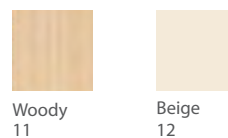

Grand Line

U-Shape Flexo Table 180 x 120 cm



Table combination



● Please Select

Complete table	Table Component	C01	C02	C0	C1	C2	C3	C4
	 Table -Top 180 x 120 cm							
	 6 Metal & Wood Legs	—	—					69965
U-Shape Table 180 x 120 cm	 4 Metal & Wood Legs & 2 Metal & Wood Legs With Casters	—	—					69966

● Please Select

Legs / Rails Colours

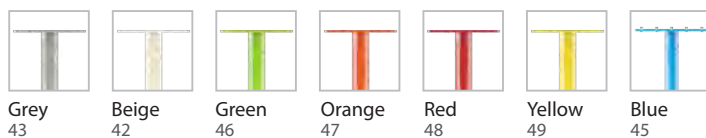

● Please Select

Table - Top Colours

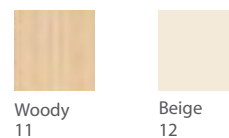

U-Shape Flexo Table

180 x 120 cm



Table combination



● Please Select

Complete table	Table Component	C01	C02	C0	C1	C2	C3	C4
	 Table -Top 180 x 120 cm	69947						
	 6 Metal Legs	—	—	69955	69956	69957	69958	69959
U-Shape Table 180 x 120 cm	 4 Metal Legs & 2 Metal Legs With Casters	—	—	69960	69961	69962	69963	69964

● Please Select

Legs / Rails Colours

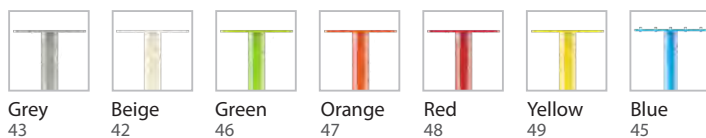

● Please Select

Table - Top Colours

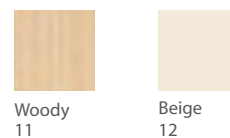





Grand Line

Circular Flexo Table ø 120 cm

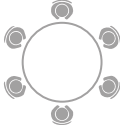

● Please Select

Complete table	Table Component	C01	C02	C0	C1	C2	C3	C4
	 Table -Top ø 120 cm							
	 4 Metal &Wood Legs	—	—					69965
Circle Table ø 120 cm	 2 Metal &Wood Legs & 2 Metal &Wood Legs With Casters	—	—					69966

● Please Select

Legs / Rails Colours

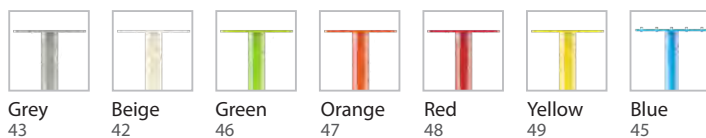

● Please Select

Table - Top Colours

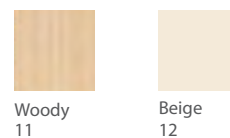





Circular Flexo Table

Ø 120 cm

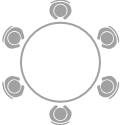

● Please Select

Complete table	Table Component	C01	C02	C0	C1	C2	C3	C4
  Circle Table Ø 120 cm	 Table-Top Ø 120 cm	69943						
	 4 Metal Legs	—	—	69955	69956	69957	69958	69959
	 2 Metal Legs & 2 Metal Legs With Casters	—	—	69960	69961	69962	69963	69964

● Please Select

Legs / Rails Colours

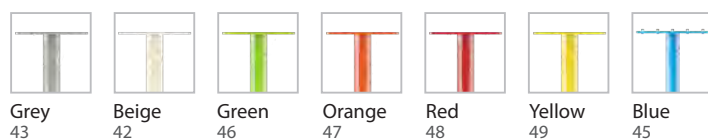

● Please Select

Table - Top Colours

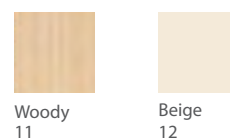

Grand Line

Circular Flexo Table

ø 90 cm



● Please Select

Complete table	Table Component	C01	C02	C0	C1	C2	C3	C4
	 Table -Top ø 90 cm							
	 4 Metal & Wood Legs	—	—					69965
Circle Table ø 90 cm	 2 Metal & Wood Legs & 2 Metal & Wood Legs With Casters	—	—					69966

● Please Select

Legs / Rails Colours

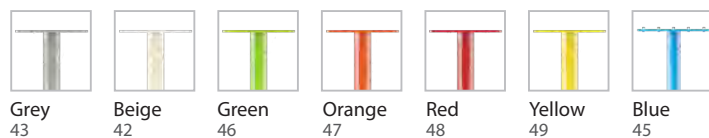

● Please Select

Table - Top Colours



90

How to order _____ Table Code - Table - Top colour Code - Legs / Rails colour Code **47077 - 11 - 47**





www.edu-fun.com

Circular Flexo Table

ø 90 cm



● Please Select

Complete table	Table Component	C01	C02	C0	C1	C2	C3	C4
  Circle Table ø 90 cm	 Table -Top ø 120 cm	69944						
	 4 Metal Legs	—	—	69955	69956	69957	69958	69959
	 2 Metal Legs & 2 Metal Legs With Casters	—	—	69960	69961	69962	69963	69964

● Please Select

Legs / Rails Colours

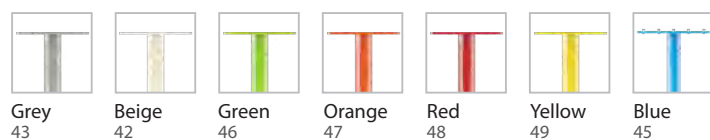

● Please Select

Table - Top Colours

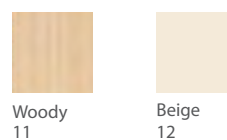

Grand Line

Simple Chair

Sturdy, durable and light chairs. Chairs are constructed with superior formed metal pipes, seat and back from environmental-friendly plywood for comfortable seating. Available in seven metal frame colours. Chairs are stackable or can be put on tabletops, allowing easy classroom cleaning.



Curved Birch plywood seat & backrest



Plastic Cap



Stackable up to 5



Chairs & Tables	Chairs Size	Chairs Code	Recommended Tables Height
C0	21 x 22.5 cm - H. 21 cm	48423	40 cm
C1	24 x 25 cm - H. 26 cm	48424	46 cm
C2	28 x 28 cm - H. 31 cm	43505	53 cm
C3	32 x 32 cm - H. 35 cm	43506	59 cm
C4	34 x 34 cm - H. 38 cm	48425	64 cm



Chairs - Metal Frame Colours



Gray
01-43



Beige
01-42



Blue
01-45



Green
01-46



yellow
01-49



Orange
01-48



Red
01-47

Seat & back colours with grey metal frame



Blue
15-43



Green
16-43



yellow
19-43



Orange
17-43



Red
18-43



Grand Line

Recommended Chairs



Flexo L Chair

Modern and ergonomically designed plastic shell to increase seating comfort. The robust seat surface resists scratches and is easy to clean. Glides guarantee stability and minimum abrasion on all types of floors. The design of the legs makes them stackable for easy storage.

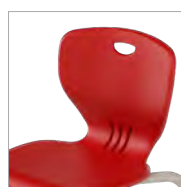

Ergonomic Plastic Shell



Plastic Glides



Stackable up to 5



Plastic Glides

Chairs & Tables	Chairs Size	Chairs Code	Recommended Tables Height
C2	30 x 30 cm - H.31 cm	43527	53 cm
C3	30 x 30 cm - H.35 cm	43528	59 cm

Shell colours with grey metal frame



Flexo N Chair

Modern and ergonomically designed plastic shell to increase seating comfort. The robust seat surface resists scratches and is easy to clean. Glides guarantee stability and minimum abrasion on all types of floors. The design of the legs makes them stackable for easy storage.



Ergonomic Plastic Shell



Plastic Glides



Chairs & Tables	Chairs Size	Chairs Code	Recommended Tables Height
C2	30 x 30 cm - H. 31 cm	43525	53 cm
C3	30 x 30 cm - H. 35 cm	43526	59 cm

Shell colours with grey metal frame



Red
38-43



Orange
37-43



Yellow
39-43



Green
36-43



Light Blue
34-43



Blue
35-43



Beige
32-43



Gray
33-43



Grand Line

Classroom **Fit Outs**

We offer custom designed room plans to fit your needs. We have a team of experts to translate your vision into functional yet inspirational learning spaces. Here are some ideas for how you can use our Harmony Line furniture pieces to create integrated kindergarten classrooms.

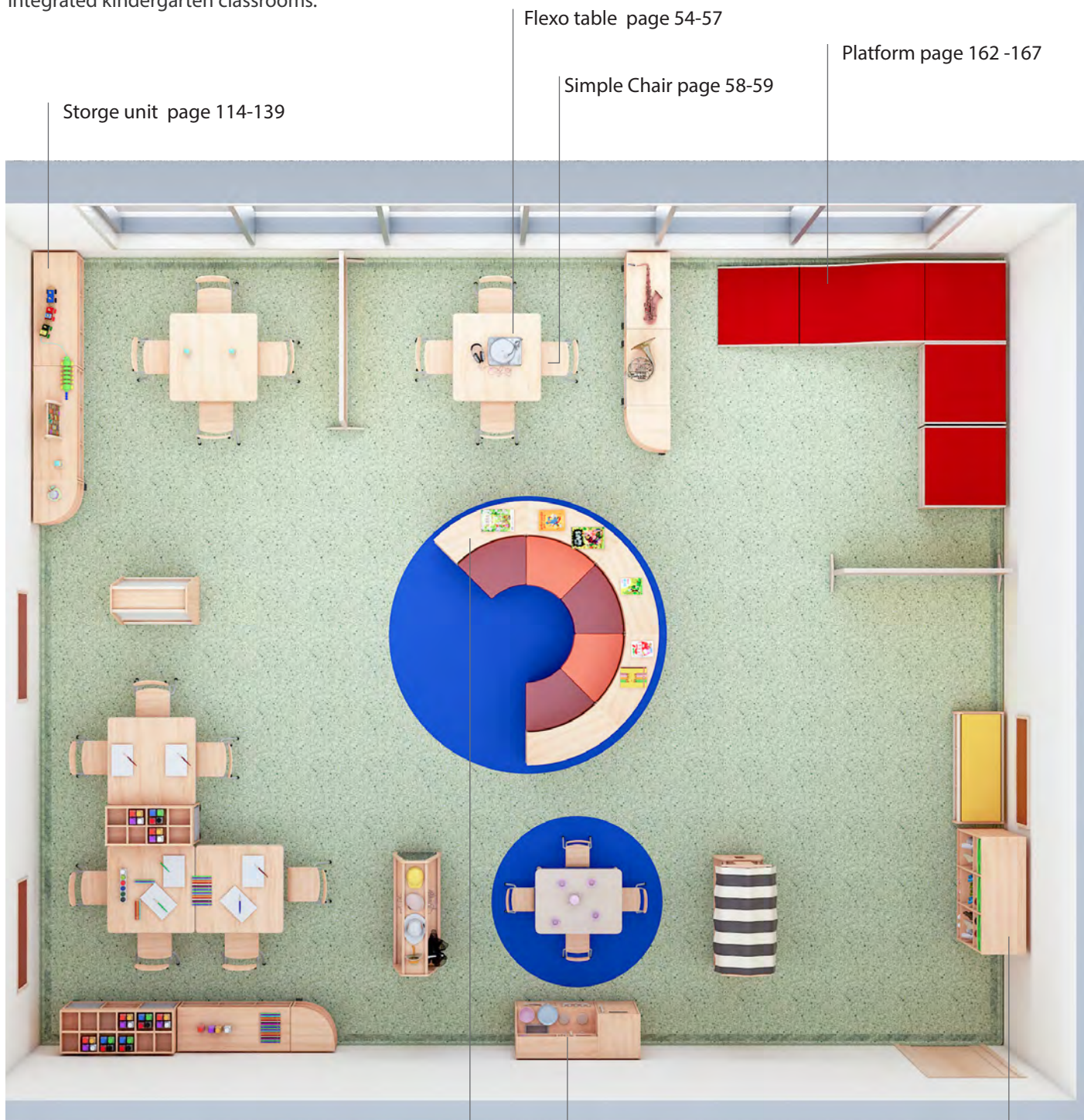



Teacher Chair

A great item for all teachers and child cCare gGivers! This chair is designed to keeps adults comfortable while still interacting with the class on their level. Unlike standard child-sized chairs, the adult- sized seat and back provide appropriate room and support for adults to sit comfortably. Made of solid beechwood.





Teacher Chair



40 x 42 cm - H. 35 cm
43281

Teacher **Deluxe** Chair

Ergonomically designed chairs that will last for generations. Each chair is made of solid, top-quality lacquered beechwood & plywood. Chairs have a curved seat and back rest.

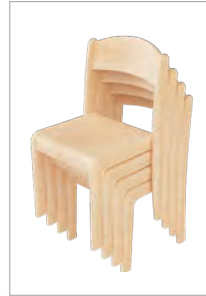

Stackable up to 5

Availabile Seats & backs Colours

- Natural plywood
01-01
- Orange
07-01
- Blue
05-01
- Green
06-01
- Red
08-01
- yellow
09-01

Teacher **Simple** Chair

Sturdy, durable and light chairs. Chairs are constructed with superior formed metal pipes, seat and back from environmentally -friendly plywood for comfortable seating. Chairs are stackable and sit sturdily and securely on tabletops without risk of toppling, allowing for easy classroom tidying.



40 x 42 cm - H. 35 cm
48428



Stackable up to 5

Availabile Seats & backs Colours

- Green
06-01
- Orange
07-01
- Blue
05-01
- Red
08-01
- yellow
09-01

Availabile frame Colours

- Gray
01-43
- Beige
01-42
- Orange
01-47
- Green
01-46
- Red
01-48
- yellow
01-49
- Blue
01-45



Stool & Benches

Our smart variety of stools and benches allow for more space in any learning environment. Comfortable yet practical stools and benches will suit almost anyone's needs. They are gentle on the floor due to the plastic glides, even after years of use. Their construction assures strength, stability and support.





Stool & Benches

Stool

A very high-quality piece of furniture. This stool is made of solid bBeechwood frame and plywood seat. Stool legs have double dowel connection lines to guarantee maximum stability. Curved leg design has no corners on which little ones can get themselves caught. Easy to assemble for storage. The neutral tone makes them perfect companions with many of our tables. The doweled plastic glides ensure no marks or divots are left on the floor even after years of use.



C0 ø 22.5 cm
H.21 cm
43020

C1 ø 25 cm
H.26 cm
43021

C2 ø 25 cm
H.31 cm
43022

C3 ø 30 cm
H.35 cm
43023

C4 ø 30 cm
H.38 cm
43024



Stool Table



This stool table comes as a new product to make a set with stools. High quality solid beechwood legs in finger jointed wooden traditional carpentry joint using a high-quality adhesive. Top from multilayer plywood laminated HPL to provide easy cleaning and durability.



Stool Table Stackable up to 2



● Please Select

Complete table	Table Component	C01	C02	C0	C1	C2	C3	C4
 <p>Stool Table</p>	 <p>Table -Top with wooden frame ø 60 cm</p>  <p>4 Wooden legs</p>	—	—	43010	43011	43012	43013	43014

● Please Select
Legs / Rails Colours



Natural plywood
01

● Please Select
Table - Top Colours



Woody
11

Stool & Benches

Stool with back

The super flexible all-rounder stool. We designed the perfect stool to pair with a kids' craft table or informal meeting area; the definition of functionalist furniture design. This simple stool is a versatile piece—it can be used as casual seating at a kitchen table, as a side table, or as extra seating. It is made from high grade birch plywood and finished with a natural based durable finish in Clear. The back rest added to provide more comfortable seating as well and stacking (2 pcs) back-to-back.



Stool with back Stackable up to 2



C4 ø 30 cm
H. 38 cm
43019



C3 ø 30 cm
H. 35 cm
43018



C2 ø 25 cm
H. 31 cm
43017



C1 ø 25 cm
H. 26 cm
43016



C0 ø 22.5 cm
H. 21 cm
43015

Deluxe Bench

This bench is made of a solid beechwood frame with laminated plywood seat. Created without sharp corners for safety. The neutral tone makes it compatible with many tables. Gentle to the floor. Doweled plastic legs. Its construction assures strength, stability and support.



C1	75 x 25 cm - H. 26 cm	43286
C2	75 x 28 cm - H. 31 cm	43287
C3	75 x 32 cm - H. 35 cm	43288



Elegance Stool & Bench

This stool and bench is made of a solid beechwood frame with laminated plywood seat. The neutral tone makes it compatible with many tables. One of our absolute best sellers, the Elegance is gentle on the floors; doweled plastic legs glide even after years of use. Its construction assures strength, stability and support.



Stackable up to 4

Elegance Bench

C0	75 x 22.5 cm - H. 21 cm	43005
C1	75 x 25 cm - H. 26 cm	43006
C2	75 x 28 cm - H. 31 cm	43007
C3	75 x 32 cm - H. 35 cm	43008
C4	75 x 34 cm - H. 38 cm	43009



Stackable up to 4

Elegance Stool

C0	21 x 22.5 cm - H. 21 cm	43000
C1	24 x 25 cm - H. 26 cm	43001
C2	28 x 28 cm - H. 31 cm	43002
C3	32 x 32 cm - H. 35 cm	43003
C4	34 x 34 cm - H. 38 cm	43004

Soft Seating

Our attractive soft seating collection is the best choice for inspirational learning areas. It can be used in many ways within any learning environment. Latest studies show that children do learn better when they are in activity-based spaces. Available in a range of fabric and leather options to suit your needs.

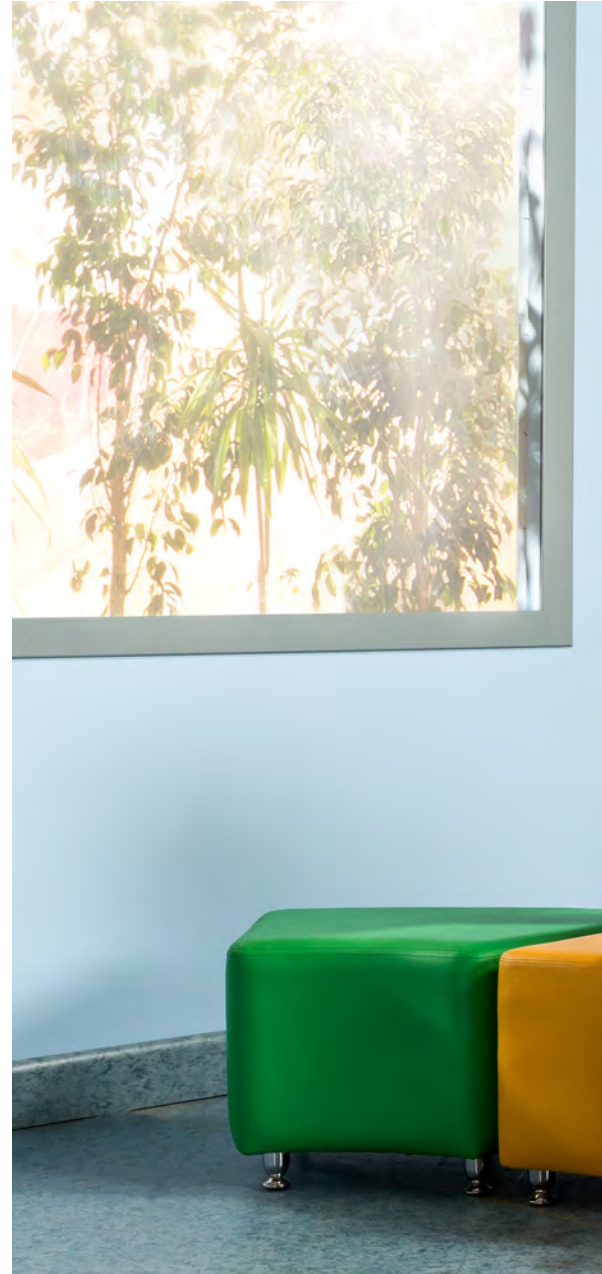



















Soft Seating

Curves - Soft Seating



Little reading corners, open spaces, reception areas all come to life with our line of pre-school and school seating, as they welcome every passer-by for a response. Six shapes snuggle into one another as you fit them together like puzzle pieces to create 3D masterpieces of art. It can be composed into different formations to give a funky, modern look to your interior.

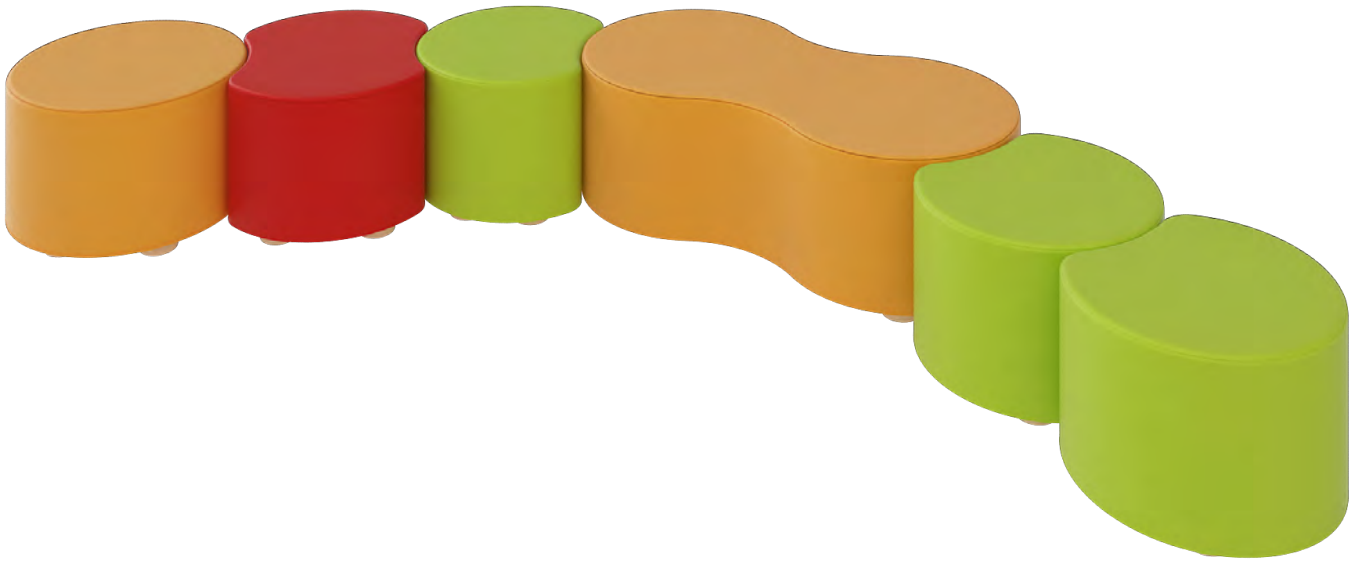

Available Colours:

											
Beige 52	Greige 83	Café Ole 84	Blue 35	Light Blue 54	Green 56	Light Green 61	Yellow 59	Orange 57	Havana 86	Brown 60	Dark-Brown 85
											
Red 58	Gray 53	Dark Gray 51	Mid-Dark Gray 55								



 <p>Circle</p>	 <p>Semi-circle</p>	 <p>Bites</p>
<p>C2 H. 31 cm - ø 45 cm - 43530</p> <p>C3 H. 35 cm - ø 45 cm - 43540</p>	<p>C2 H. 31 cm - ø 45 cm - 43533</p> <p>C3 H. 35 cm - ø 45 cm - 43543</p>	<p>C2 H. 31 cm - ø 45 cm - 43531</p> <p>C3 H. 35 cm - ø 45 cm - 43541</p>
 <p>Infinity</p>	 <p>Corner</p>	 <p>Big Circle</p>
<p>C2 H. 31 cm - 90 x 45 cm - 43532</p> <p>C3 H. 35 cm - 90 x 45 cm - 43542</p>	<p>C2 H. 31 cm - 66.5 x 47.5 cm - 43534</p> <p>C3 H. 35 cm - 66.5 x 47.5 cm - 43544</p>	<p>C2 H. 31 cm - ø 60 cm - 43535</p> <p>C3 H. 35 cm - ø 60 cm - 43545</p>

Soft Seating

Cushions seating

These soft cushions are the best choice for the modern way in learning. They offer children the opportunity to sit comfortably without feeling restricted, which helps them concentrate better. Children can use them in reading corners at story time or just sitting on them looking at their favourite books. It is also compatible with our Elegance and Ultra from (C01: C0) tables so they can be used for different activities and ages in which a table is required.



Circle
H.7.5 cm - ø 40 cm - 43550



Available Colours



Beige
52



Greige
83



Café Ole
84



Blue
35



Light Blue
54



Green
56



Light Green
61



Yellow
59



Orange
57



Havana
86



Brown
60



Dark-Brown
85



Red
58



Gray
53



Dark Gray
51



Mid-Dark
Gray 55



Cushions stand

For ten Cushions



46 x 46 x 90 cm - 43555

Storage Units

Offering versatile storage systems, our range will keep your preschool educational spaces more functional and looking neat and tidy. With modern styling, our storage is available in natural or colourful themes to match all the creative educational functional environment spaces and can be configured to suit the requirements of any of layout. Our range has been designed also to separate spaces for different activities and to match with our table and chair systems. Available in an array of sizes and colours.

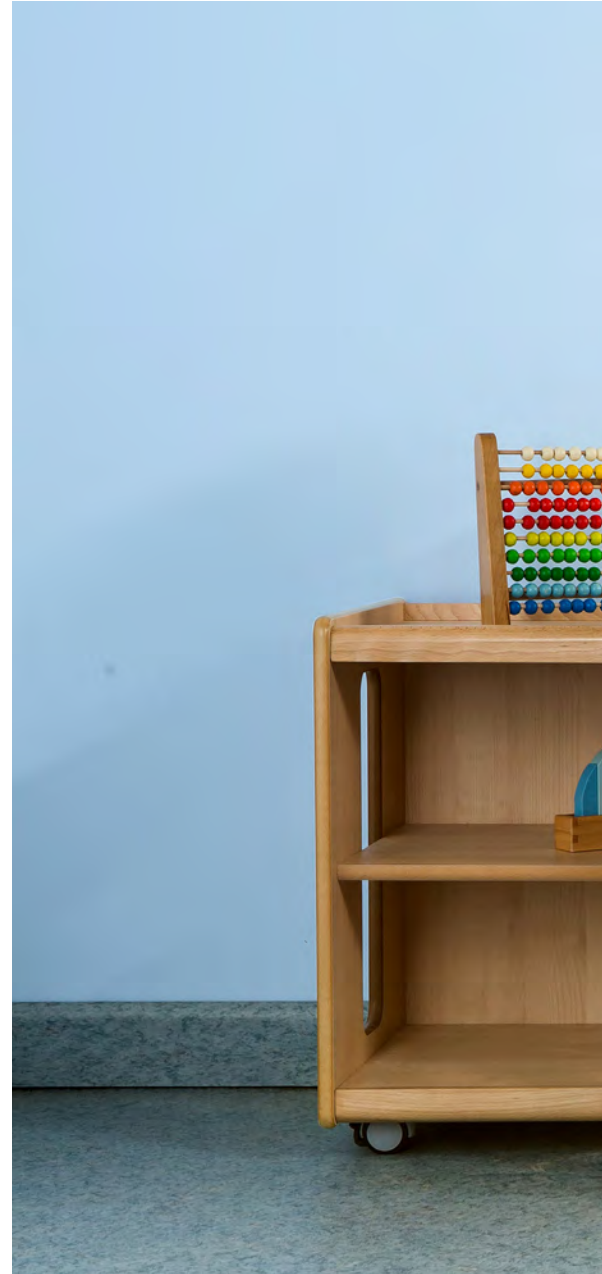



Storage Units

Ultimate N Storage Units

As well as looking attractive, this series of tray storage units are flexible and versatile. This collection was designed to fulfill the storage needs of any learning environment like kKindergarten cClassrooms and art classrooms.



Curvy edges for more safety.



Solid beech pProfile.



Heavy-duty lockable castors



See Through storage units



Wall storage units



Storage Units

Ultimate N Storage Units wide range of width & height

Wall storage units



See Through storage units



Wall storage units



See Through storage units



Wall storage units



Ultimate N Curved Storage Units

Quarter storage units

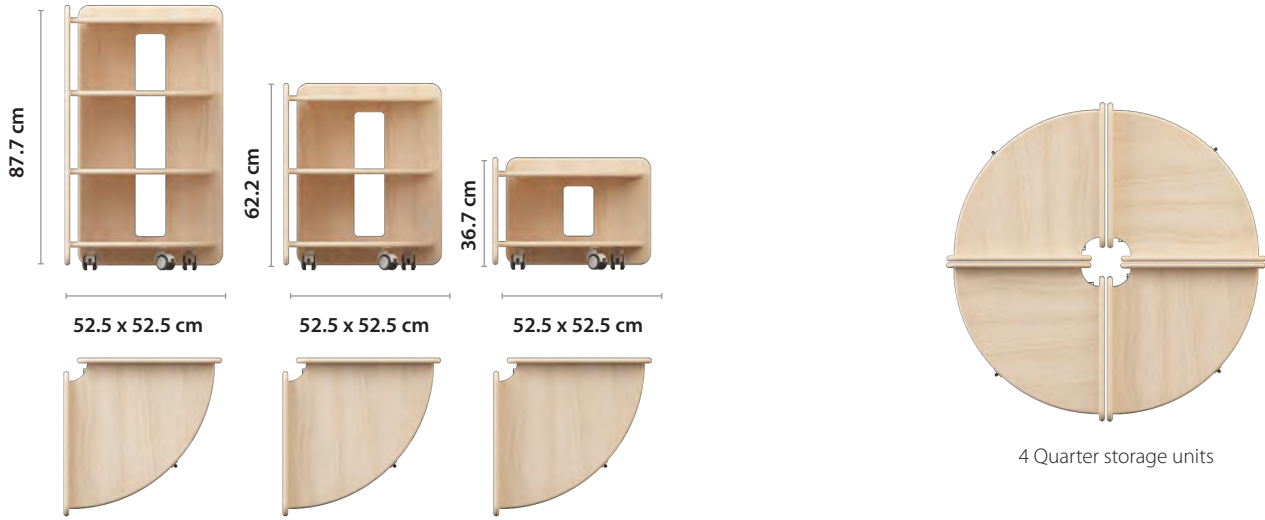

Quarter storage units

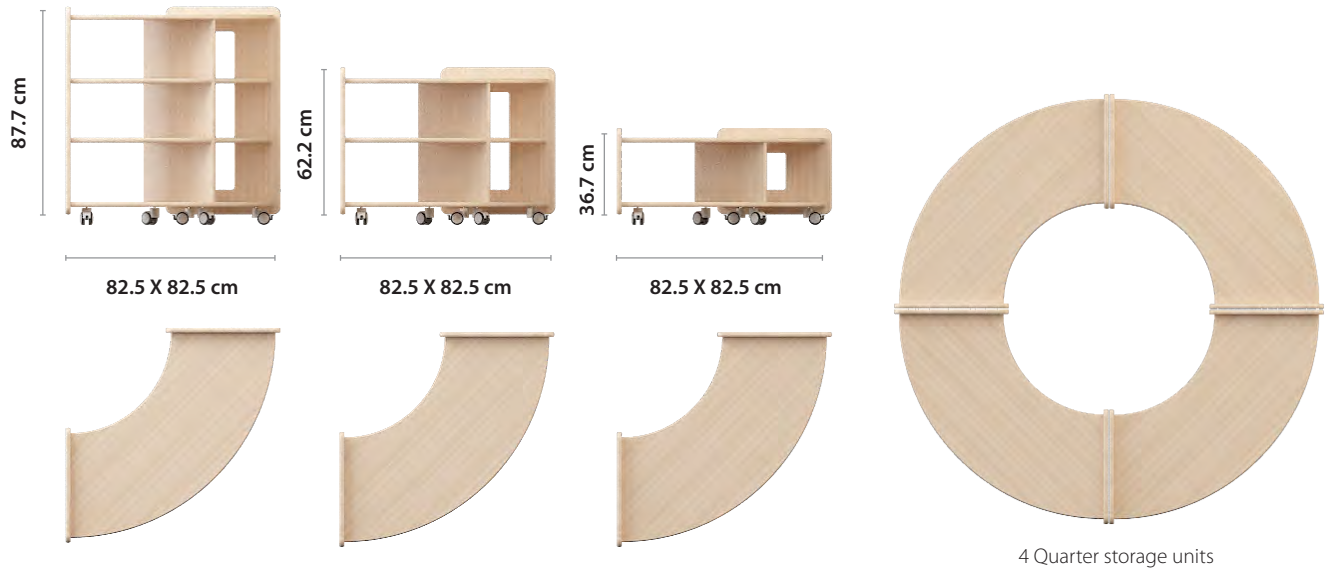

Semi Quarter storage units

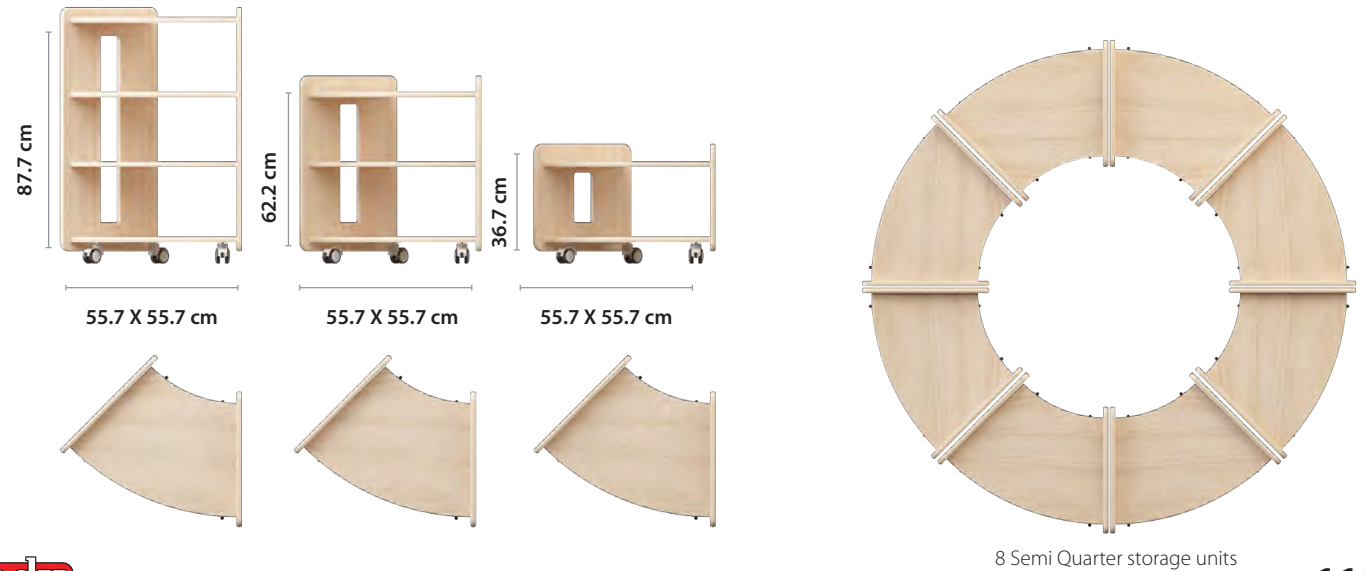

Storage Units

Classroom **Fit Outs**

We offer custom designed room plans to fit your needs. We have a team of experts to translate your vision into functional yet inspirational learning spaces.

Here are some ideas for how you can use our Ultimate N Storage units to create integrated kindergarten classrooms.

Delux Chair page 30-31

Platform page 162 -167



Elegance table
page 20-29

Ultimate N Curved Storage unit
page 132-135

Ultimate N Storage Units
page 114-131

Coat lockers & cubbies
page 140-143



Ultimate N Storage Units Combination

Curved Ultimate N Storage Units
Size : 82.5 x 82.5 x 62.2 cm

Curved Ultimate N Storage Units
Size : 55.7 x 55.7 x 62.2 cm

Ultimate N
Storage Units
Size : 136.8 x 45 x 62.2 cm

Ultimate N
Storage Units
Size : 103 x 45 x 62.2 cm

Curved Ultimate N Storage Units
Size : 52.5 x 52.5 x 62.2 cm

Ultimate N Storage Units
Size : 120 x 45 x 62.2 cm

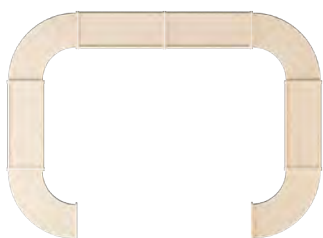

Storage Units

Ultimate N Storage Units

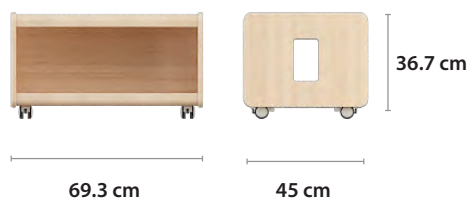

45481

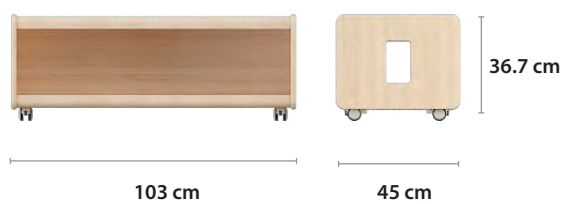

45489

Units Colour _____



Wood
01



45482

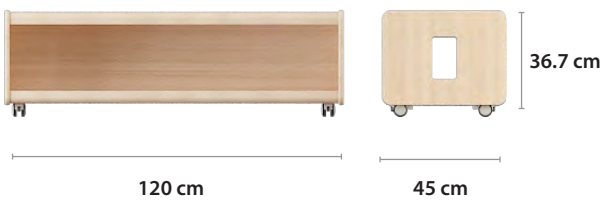

45483



Units Colour _____



Wood
01

Storage Units

Ultimate N Storage Units See Through



45490

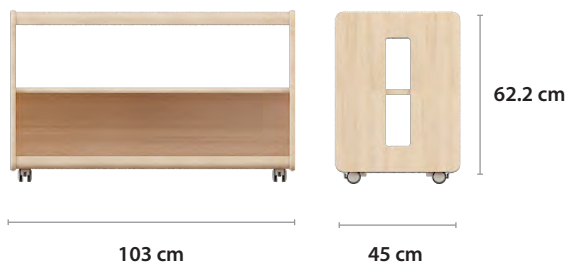

45494



Storage Units

Ultimate N Storage Units



45491

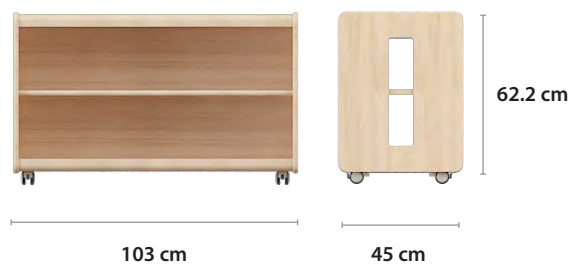

45495



Storage Units

Ultimate N Storage Units See Through



45486



45492



Storage Units

Ultimate N Storage Units



45692



45493



Storage Units

Ultimate N Curved Storage Units



45416



45417



45418

Units Colour



Wood
01



45426



45421



45427

Units Colour



Wood
01

Storage Units

Ultimate N Curved Storage Units



45413



45414



45415

Units Colour



Wood
01



Storage Units

Materials Cabinets

The style of this collection is based on following curves, organic forms and natural colours. The beauty of high-quality beechwood is demonstrated in each piece of this collection. Fantastic for both Montessori classrooms and normal classrooms. Some cabinets are designed according to some of the Montessori approved materials, such as Pink Tower or Brown Stairs materials.

As well as looking attractive, this series of storage units are flexible and versatile. This collection was designed to fulfill the storage needs of any learning areas.



As well as looking attractive, this series of storage units are flexible and versatile. This collection was designed to fulfill the storage needs of any learning



Safety edges

All units are available with *casters or metal frame & legs*, please select **unit code** and add casters or metal frame & legs code



Heavy-duty lockable casters

With casters 90



With Steel base

100 x 37 x H. 9 cm

96

67 x 37 x H. 9 cm

95



Available in 3 Heights and 2 widths



Storage Units

W 70 x D 40 x H 28.5 cm

W 103.5 x D 40 x H 28.5 cm

Materials Cabinets



45440



45441

W 103.5 x D 40 x H 55.3 cm



45456



45446

W 70 x D 40 x H 82 cm



45455



45449

W 70 x D 40 x H 55.3 cm



45443



45448

W 103.5 x D 40 x H 82 cm



45451



45450

W 103.4 x D 103.4 x H 55.3 cm



67375

Coat Lockers & cubbies

With our classroom-friendly storage lockers and cubbies, you can keep all your students' belongings in one convenient location. All lockers are easily accessible for little ones to hang up coats and backpacks all by themselves! The upper shelf is ideal for storing lunches, extra clothes and more. They can be paired with the ultimate storage units, which have a perfect seat for children to sit while putting on their shoes, ready to go out to play.





Coat Lockers & cubbies

Coat locker unit

These sturdy units provide convenient storage space for organizing classrooms. They are available in double, triple and quadruple units. Each unit contains two plastic trays with anti-fall safety runners included. Also, it can be equipped with shelf for shoes. Made of high quality MDF.



137 x 40 x 112 cm **64105**



103.6 x 40 x 112 cm **64106**



69.6 x 40 x 112 cm **64107**

Ultimate Storage Units

These ultimate storage units have a perfect seat for children to sit while putting on their shoes, ready to go out to play. Three sizes available: single, double and triple units to suit different requirements.



35 x 45 x 35 cm

45171



70 x 45 x 35 cm

45172

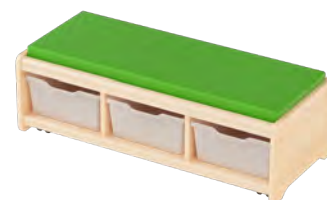

103.5 x 45 x 35 cm

45173



Soft Play

Studies show that active play aids a child's physical, mental, social and emotional well-being as they mature. Soft play corners are the most comprehensive and safe ways for children to develop. Our collection of soft play pieces are designed to give children a safer place to play. Our collection of soft play suits little children and offers them endless hours of fun and joy.











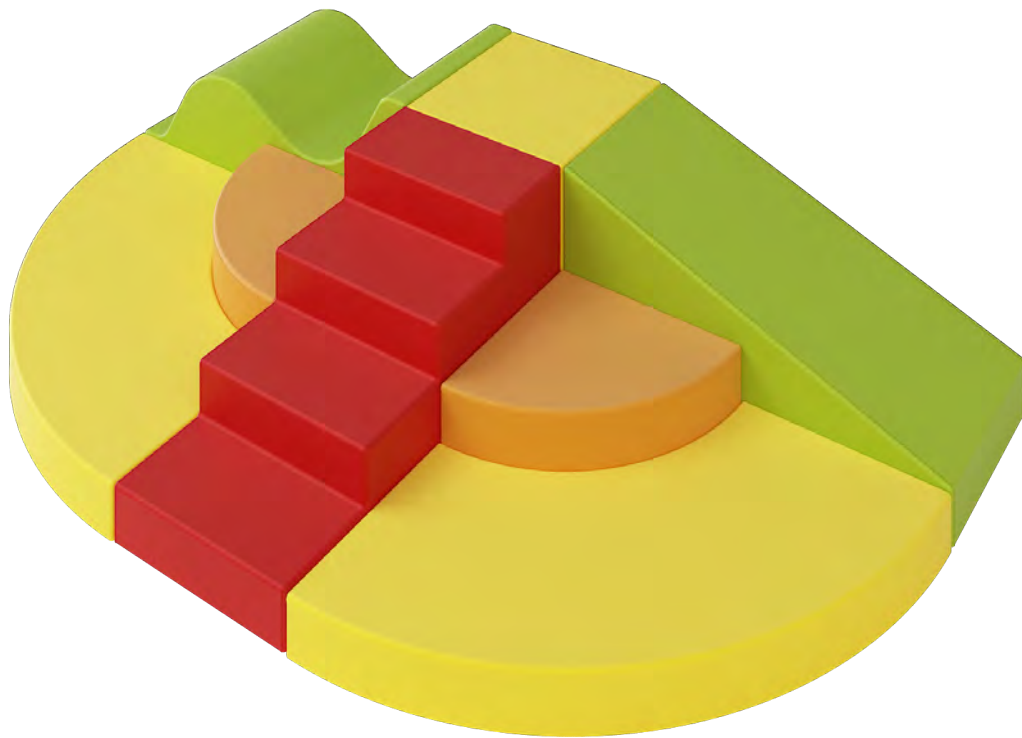
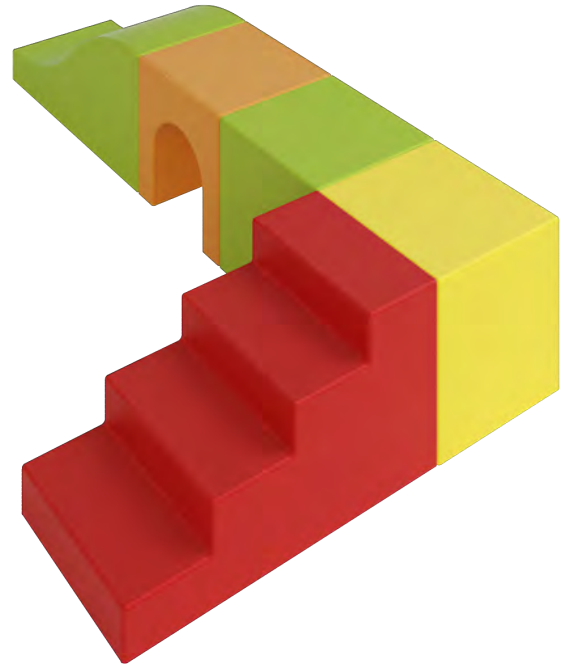











Soft Play



Multi Activity Soft Play

Children will have a lot of fun with these geometric shapes. Each shape's edge invites another shape to nestle, encouraging interactive play among the soft shapes. The warm natural colours help children to relax and concentrate. Made of high-density foam covered with leather. Easy to clean with soapy water. Recommended for ages between 3 and 6 years.





Available Colours:

											
Beige 52	Greige 83	Café Ole 84	Blue 35	Light Blue 54	Green 56	Light Green 61	yellow 59	Orange 57	Havana 86	Brown 60	Dark-Brown 85
											
Red 58	Gray 53	Dark Gray 51	Mid-Dark Gray 55	Black 62							

	
<p>Semi-Circular Mat</p> <p>100 x 100 x 12.5 cm 45986</p>	<p>Tunel</p> <p>50 x 50 x 50 cm 45988</p>

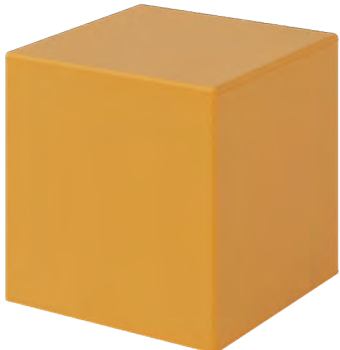
		
<p>Slide</p> <p>100 x 50 x 50 cm 45980</p>	<p>Ladder</p> <p>100 x 50 x 50 cm 45981</p>	<p>Gentle Wave</p> <p>100 x 50 x 50 cm 45982</p>

		
<p>Two waves</p> <p>100 x 50 x 50 cm 45983</p>	<p>Square</p> <p>50 x 50 x 50 cm 45984</p>	<p>Quadrant Corner</p> <p>50 x 50 x 25 cm 45985</p>







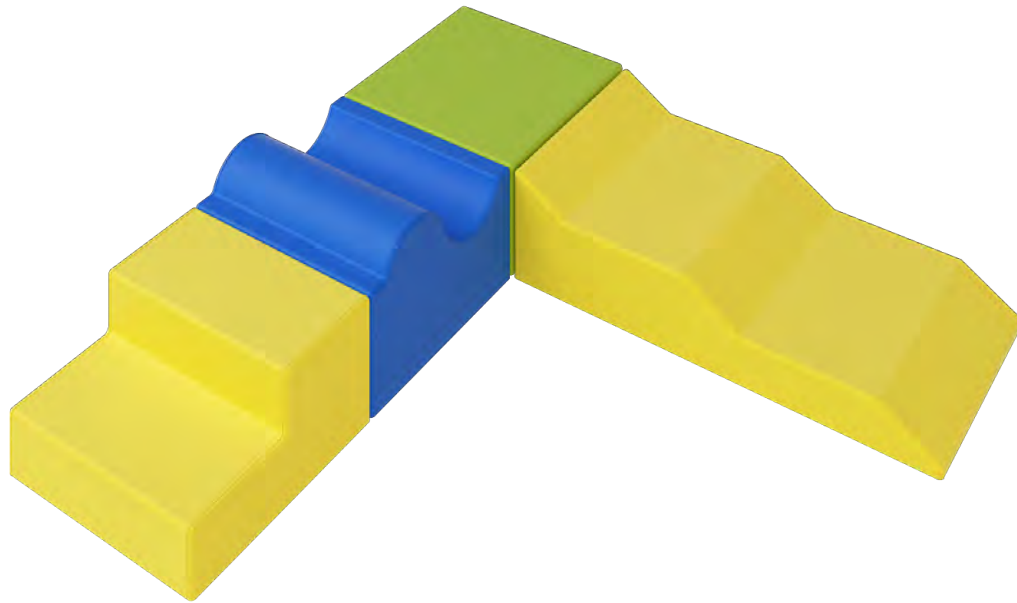









Soft Play



Multi Activity Soft Play - Small

Children will have a lot of fun with these geometric shapes. Each shape's edge invites another shape to nestle encouraging interactive play among the soft shapes. The warm natural colours help children to relax and concentrate. Made of high-density foam covered with leather. Easy to clean with soapy water. Recommended for ages between 0 and 3 years.



Available Colours:

											
Beige 52	Greige 83	Café Ole 84	Blue 35	Light Blue 54	Green 56	Light Green 61	yellow 59	Orange 57	Havana 86	Brown 60	Dark-Brown 85
											
Red 58	Gray 53	Dark Gray 51	Mid-Dark Gray 55								

	
<p>Small Quadrant Corner</p> <p>50 x 50 x 6.5 cm 45995</p>	<p>Square</p> <p>50 x 50 x 25 cm 45990</p>

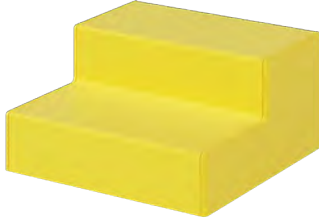
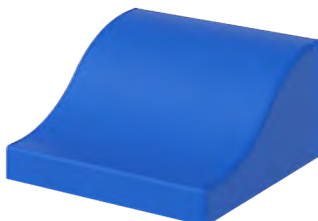
		
<p>small slide</p> <p>50 x 50 x 25 cm 45993</p>	<p>small ladder</p> <p>50 x 50 x 25 cm 45992</p>	<p>small gentle curve</p> <p>50 x 50 x 25 cm 45994</p>

		
<p>Big wave</p> <p>50 x 50 x 32 cm 45996</p>	<p>Small wave</p> <p>50 x 50 x 32 cm 45991</p>	<p>Slide ladder</p> <p>50 x 50 x 25 cm 45997</p>

Soft Play

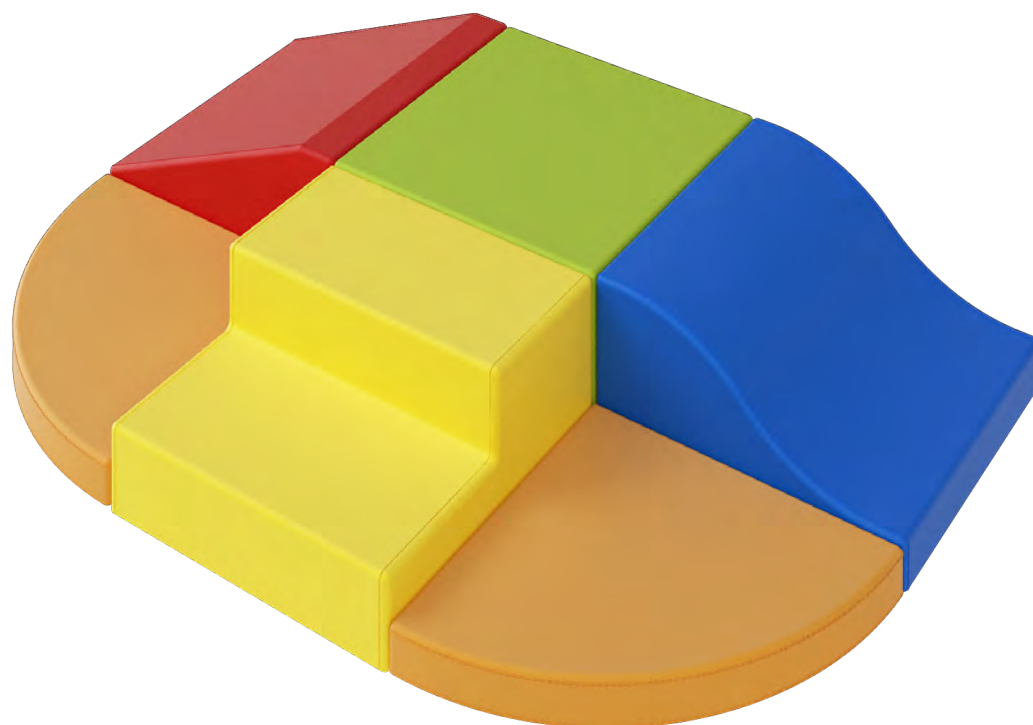
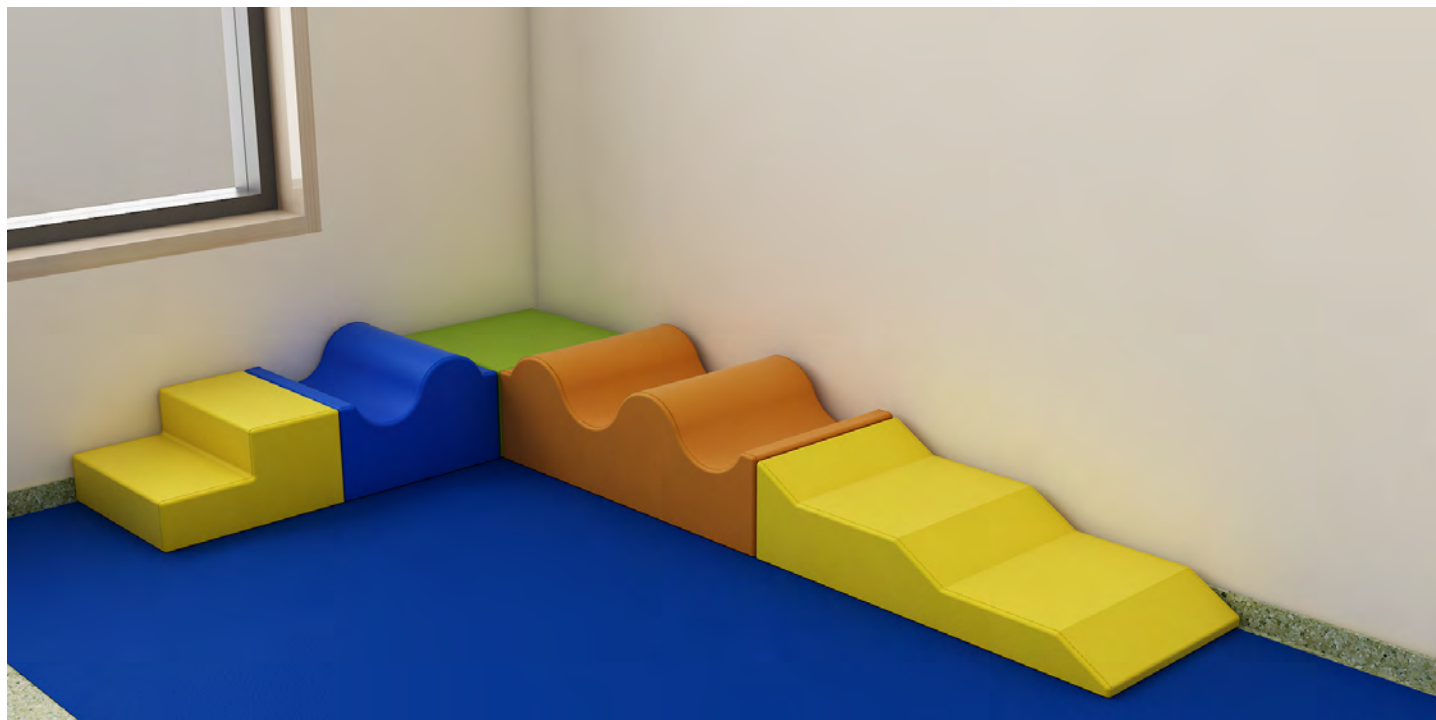

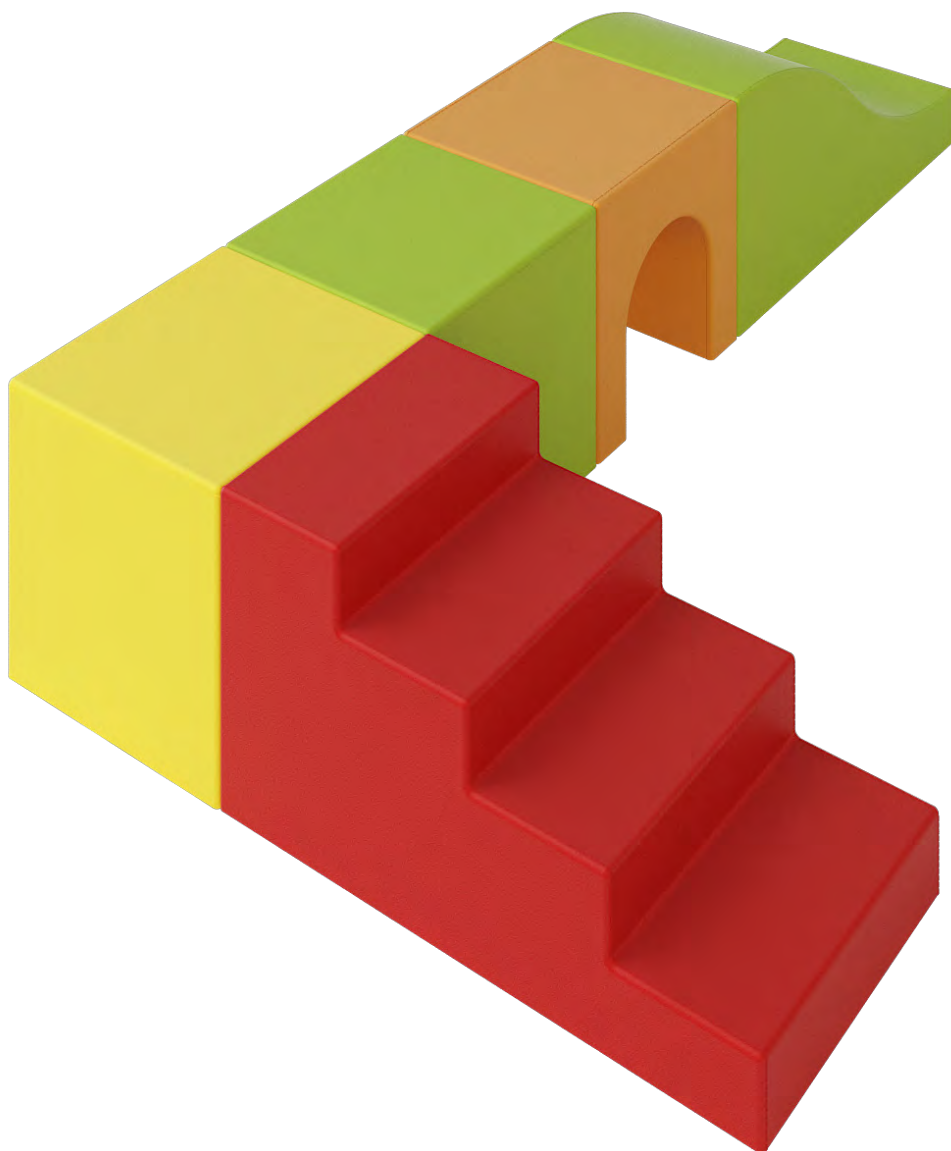
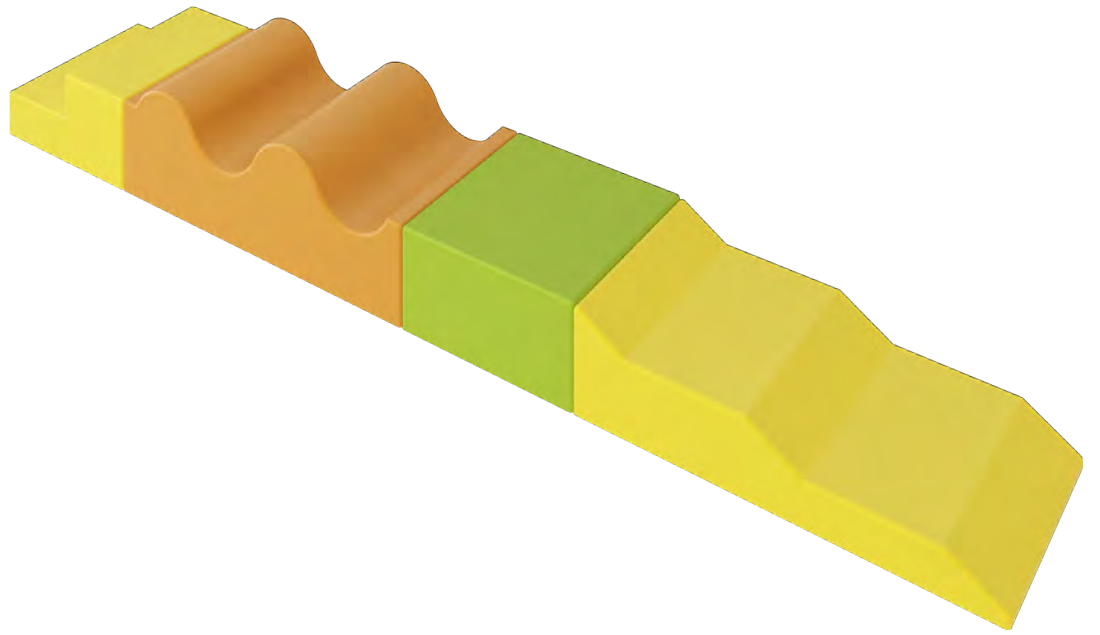

Room Dividers

High quality, durable and functional wood modular room dividers. With these dividers, the creation of a separate play areas within a large room will be easy. These dividers are ideal for organising classroom areas and creating a variety of spaces for playing, reading, drawing and so on. Also, they are great for creating an infant or child play area as a self-contained area. In addition, children can have fun with these dividers, as they can write on the whiteboard or colour on the transparent surface. The frame is made of high-quality beechwood.





Room Dividers

Room Dividers Units

Classroom spaces should be flexible by using mModular panels and shelving units to create room dividers, define spaces, and establish boundaries. Panels can be more than dividers. The see-through pPanel will give you a connection with children while they play. Attach mirror, clear or cork cover to any room panels to add vVisual motivation or display artwork.

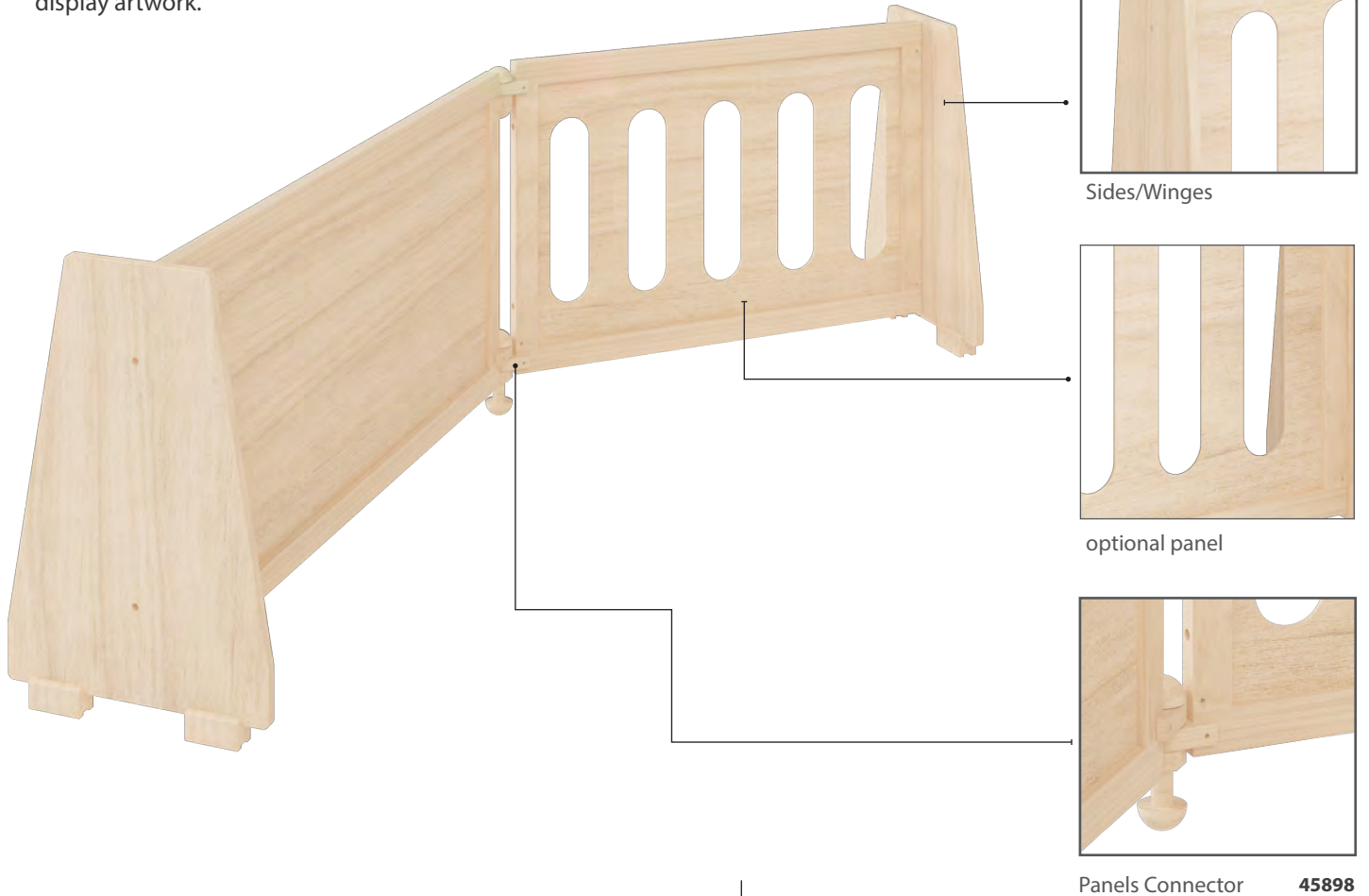



Room dividers units Size & Hight



Room Dividers

Solid Panels



panels W 87 cm*		panels W 127 cm*		Sides / wings	
					
W 87 cm x H 31.5 cm	45870	W 127 cm x H 31.5 cm	45873	W 40 cm x H 33.7 cm	45895
					
W 87 cm x H 57 cm	45871	W 127 cm x H 57 cm	45874	W 40 cm x H 59 cm	45896
					
W 87 cm x H 82.5 cm	45872	W 127 cm x H 82.5 cm	45875	W 40 cm x H 84.7 cm	45897

* Sides are not included

See-Through Panels





panels W 87 cm*		panels W 127 cm*		Sides / wings	
—		—		—	
W 87 cm x H 57 cm	45876	W 127 cm x H 57 cm	45878	W 40 cm x H 59 cm	45896
W 87 cm x H 82.5 cm	45877	W 127 cm x H 82.5 cm	45879	W 40 cm x H 84.7 cm	45897

* Sides are not included

Room Dividers

Acrylic/Clear Panels









panels W 87 cm*		panels W 127 cm*		Sides / wings	
					
W 87 cm x H 31.5 cm	45880	W 127 cm x H 31.5 cm	45882	W 40 cm x H 33.7 cm	45895
					
W 87 cm x H 57 cm	45881	W 127 cm x H 57 cm	45883	W 40 cm x H 59 cm	45896
—		—		—	

* Sides are not included

Mirror Panels











panels W 87 cm*		panels W 127 cm*		Sides / wings	
					
W 87 cm x H 82.5 cm	45884	W 127 cm x H 82.5 cm	45886	W 40 cm x H 84.7 cm	45895
					
W 87 cm x H 57 cm	45885	W 127 cm x H 57 cm	45887	W 40 cm x H 59 cm	45896
—		—		—	

* Sides are not included

Room Dividers

Cork Panels



panels W 87 cm*		panels W 127 cm*		Sides / wings	
					
W 87 cm x H 31.5 cm	45888	W 127 cm x H 31.5 cm	45890	W 40 cm x H 33.7 cm	45895
					
W 87 cm x H 57 cm	45889	W 127 cm x H 57 cm	45891	W 40 cm x H 59 cm	45896
—		—		—	

* Sides are not included



Platform

An ideal way to create the best play area for children. Platforms create interest, height differentiation and lots of fun. Made of solid beechwood for durability. Our platforms promote balance and spatial cognition because children must move in many ways to manoeuvre the platforms.

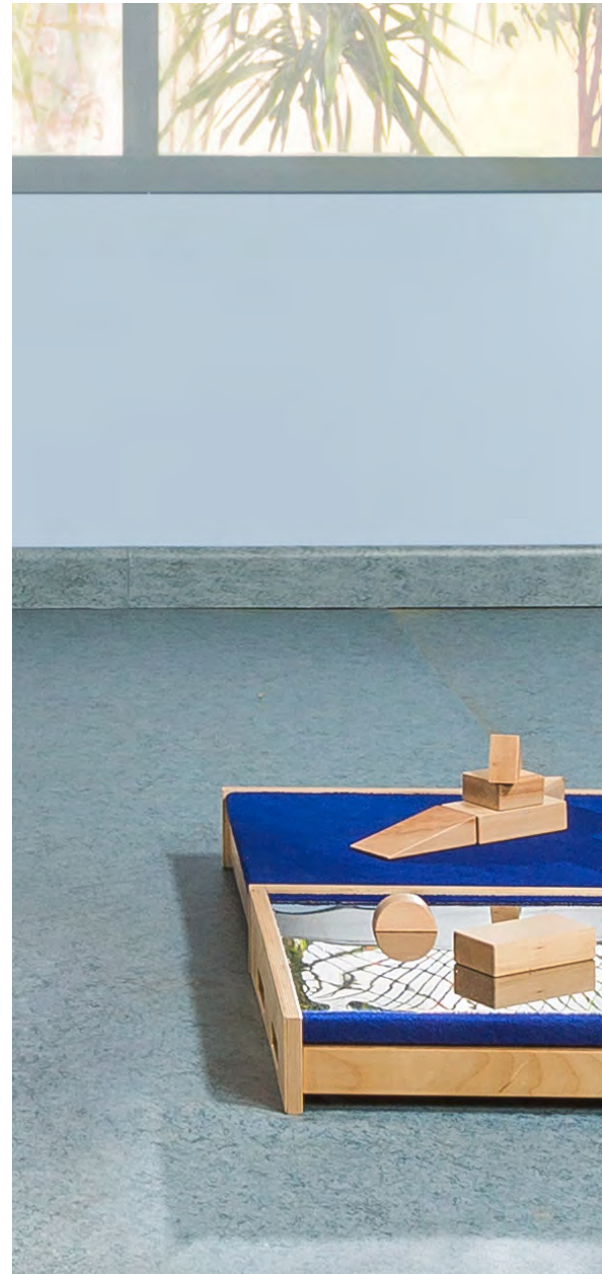



Platform

Large Platform

These platforms are available in 9 shapes in 3 different heights. The varying heights encourage movement for children. It can also be used as a playing corner. Handles are available to move and carry easily. High units have a tunnel system to add more fun for children to crawl under. Surfaces are covered with heavy-duty carpets or a safe mirror.





<p>75 X 75 X 30 cm 45968</p>	<p>75 X 75 X 30 cm 45960</p>	<p>112.5 X 75 X 45 cm 45963</p>
<p>75 X 75 X 45 cm 45967</p>	<p>75 X 75 X 15 cm 45962</p>	<p>75 X 37.5 X 15 cm 45964</p>
<p>75 X 75 X 15 cm 45961</p>	<p>75 X 75 X 15 cm 45966</p>	<p>75 X 75 X 15 cm 45965</p>

Platform

Small Platform

Designed especially for young children. It can also be used as a playing corner in your learning spaces. Nine shapes are available in 3 different heights. The varying heights encourage movement and imagination for children. Handles are available to move and carry easily. High units have a tunnel system to add more fun for children to crawl under. Surfaces are covered with heavy-duty carpets or a safe mirror.

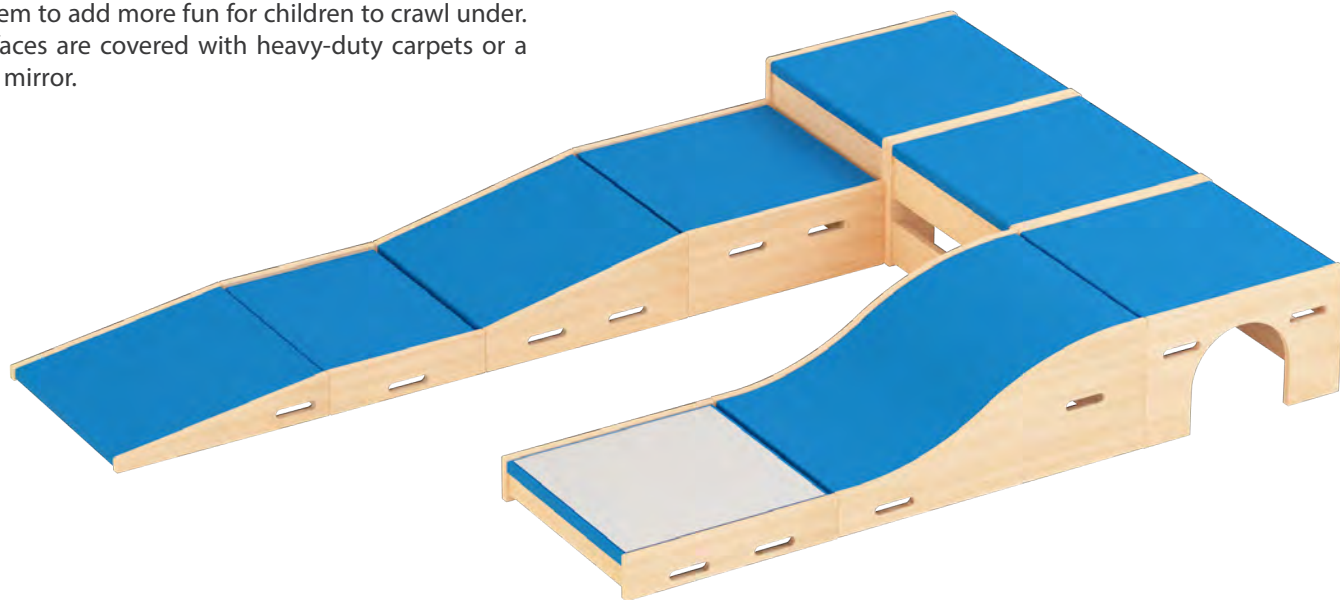

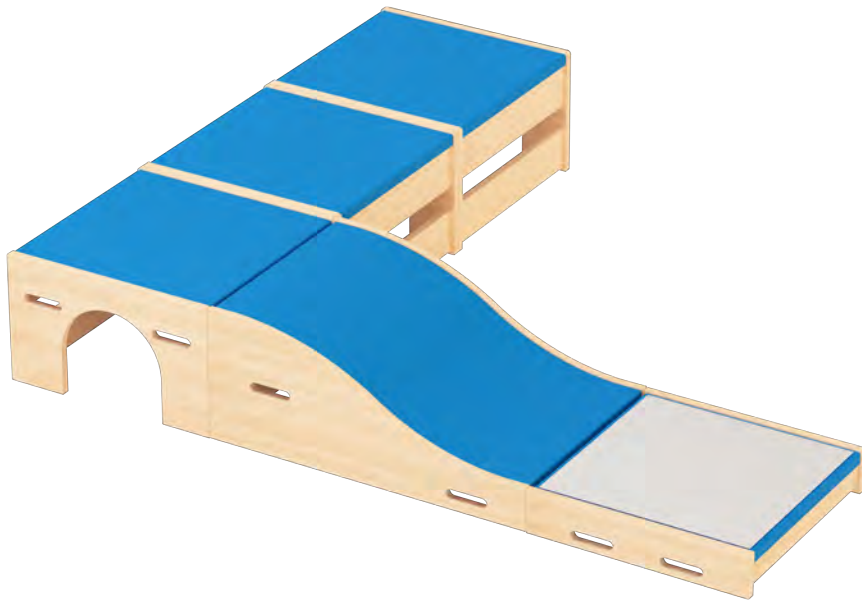

<p>50 x 50 x 20 cm 45970</p>	<p>50 x 50 x 20 cm 45971</p>	<p>75 x 50 x 30 cm 45972</p>
<p>50 x 50 x 30 cm 45973</p>	<p>50 x 50 x 10 cm 45976</p>	<p>50 x 37.5 x 10 cm 45975</p>
<p>50 x 50 x 10 cm 45977</p>		

Toddler

The toddler years are a time of great cognitive, emotional and social development. Toddler children from 1 to 4 years need to have their own classroom furniture that embraces their physical development at this age. We have designed in this section a variety of chairs and tables, which will suit your needs every time.





Toddler

Chairs

Tables



Size Chart

We design all of our furniture collection according to the European standards for 'chairs and tables for educational institutions' which was approved in January 2007. Children should always use the appropriate size of chairs or table to ensure good posture and prevent causing problems or distortions for them while growing. Ergonomic seating requires adjustable furniture to suits different body heights.

In this table you can choose the correct seat and table height suitable for the student age:

BS EN 1729 European standards for chairs and tables

Children`s ages	0 - 2 yrs		2 - 3 yrs	2 - 4 yrs	4 - 6 yrs	6 - 8 yrs	8 - 11 yrs
Chairs & Tables Symbol	C 01	C 02	C 0	C 1	C 2	C 3	C 4
Chairs seat height	13 cm	17 cm	21 cm	26 cm	31 cm	35 cm	38 cm
Tables height - Fixed legs	30 cm	36 cm	40 cm	46 cm	53 cm	59 cm	64 cm
	Infant/toddler chairs & tables Pages : 168-181			Preschool/elementary chairs & tables Pages : 12 - 97			



Toddler



Elegance Toddler Chair

This beautifully crafted armed chair would look great in any nursery or day care centre. Special sizes are made specifically for little ones to give them comfort and support. It is made of solid, top-quality lacquered beechwood and is built to last.

Availabile Colours

- Natural plywood
01-01
- Orange
07-01
- Green
06-01
- Blue
05-01
- yellow
09-01
- Red
08-01



Arm

- C01 **43211** 19 x 20 cm - H. 13 cm
- C02 **43212** 21 x 22.5 cm - H. 17 cm
- C0 **43206** 21 x 22.5 cm - H. 21 cm



Deluxe Toddler Chair

A natural armed chair that will last for generations. The ergonomically curved seat and backrest provide the most comfortable seating for little children. Its special size is made specifically for toddlers. It is made of solid, top-quality lacquered beechwood and plywood.

Availabile Colours

- Natural plywood
01-01
- Orange
07-01
- Green
06-01
- Blue
05-01
- yellow
09-01
- Red
08-01



Arm

- C01 **43217** 19 x 20 cm - H. 13 cm
- C02 **43218** 21 x 22.5 cm - H. 17 cm
- C0 **43265** 21 x 22.5 cm - H. 21 cm





Captain Toddler Chair

A classic style seating made from high quality solid beechwood with a recessed wooden seat base and a wrap-around seat back, providing back and side support for children. Suitable for growing toddlers who are starting to become more independent but still providing much needed security. Durable varnish in natural polished finish, robustly constructed for heavy usage and long lasting.



Metal bracket & solid massive beech leg



C01 45 x 40 cm - H. 13 cm
43513



C02 45 x 40 cm - H. 17 cm
43514



C0 45 x 40 cm - H. 21 cm
43515

Toddler

Chairs & Benches

These wooden chairs are the perfect choice for toddlers. Excellent for child-care centres, nurseries or children's rooms at home. It encourages your young ones to sit in a proper way. Designed with safe edges and manufactured from HQ beechwood and with a lacquered finish.

Kinder chairs and benches are available in 3 sizes. Toddler chair is available in 1 size.

Kinder Chair & Benches



- C01 43607 75 x 20 cm - H. 13 cm
- C02 43608 75 x 22.5 cm - H. 17 cm
- C0 43606 75 x 22.5 cm - H. 21 cm
- C1 43605 75 x 25 cm - H. 26 cm



- C01 43602 19 x 20 cm - H. 13 cm
- C02 43603 21 x 22.5 cm - H. 17 cm
- C0 43601 21 x 22.5 cm - H. 21 cm
- C1 43600 24 x 25 cm - H. 26 cm



Stool Stackable up to 4



Flip around Chair

This infant to toddler-sized chair is perfect for small children. The chair is light and children can reposition it themselves. The seat height is different when you turn it over, or can be used as a small independent desk. Oval holes on its sides facilitate handling. Chairs are made from laminated plywood. Benches are also available.

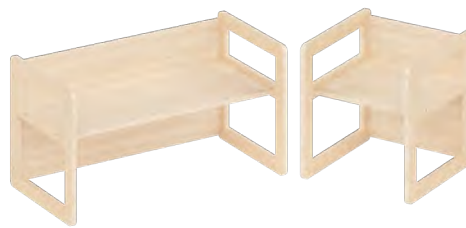

Chair	43340	30 x 32 cm - H.31 cm
Bench	43345	67 x 30 cm - H.31 cm

Chair



seat h 17
Chair 30 x 26 x 32 cm



Table 30 x 32 x 26 cm



Bench



seat h 21
Bench 63 X 31.2 X 32.8 cm



seat h 13



Table 63 X 31.2 X 32.8 cm

Tables



Big 73 X 42.8 X 41.2 cm

43340



Small 43 X 42.8 X 41.2 cm

43345



Toddler

Elegance Tables

These flexible movable creative tables combine contemporary looks, functionality as well as flexibility and encourage social behaviour, creativity and cooperation among students. It comes in a variety of unique shapes and sizes. Each shape and size has its merits and benefits, depending on the learning situation. Tables can be combined with each other or with other tables combining a multitude of layouts creating an attractive look. Tables are made of Medium-density fiberboard (MDF) covered by high-pressure laminate (HPL), with PVC edge banding. Legs are either fixed or adjustable to offer different heights, an advantage for mixed age groups.

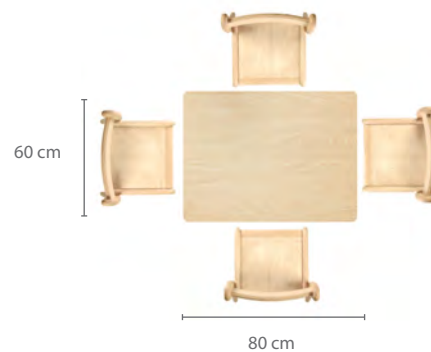
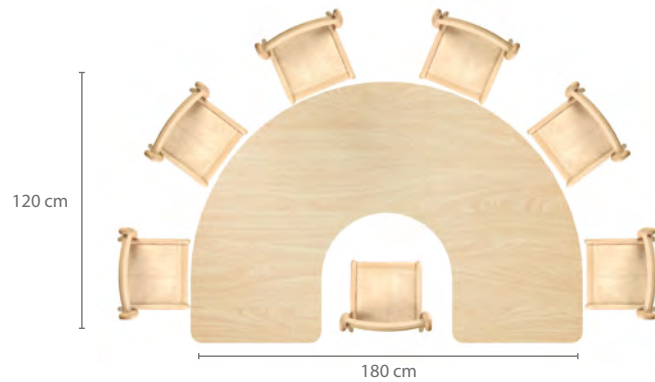





Stages & Symbol

- C01 - Toddler1 30 cm
- C02 - Toddler2 36 cm
- C0 - Nursery1 40 cm



Table Top Option 22 mm MDF Laminated HPL solid beech edges

 <p>Elegance Table 52 x 120 cm</p>	C 01	48020
	C 02	48021
	C 0	44201
 <p>Elegance Table 60 x 80 cm</p>	C 01	48022
	C 02	48023
	C 0	44321
 <p>Elegance Table 60 x 120 cm</p>	C 01	48024
	C 02	48025
	C 0	44331
 <p>Elegance Table 120 x 180 cm</p>	C 01	48026
	C 02	48027
	C 0	44670
 <p>Elegance Table ø 120 cm</p>	C 01	48028
	C 02	48029
	C 0	44410
 <p>Elegance Table 60 x 60 cm</p>	C 01	48030
	C 02	48031
	C 0	44690

Legs / Rails Colours



Natural plywood
01

Table - Top Colours



Woody
11



Beige
12

Toddler

Ultra Tables

These flexible movable creative tables combine contemporary looks, functionality as well as flexibility and encourage social behaviour, creativity and cooperation among students. It comes in a variety of unique shapes and sizes. Each shape and size has its merits and benefits, depending on the learning situation. Tables can be combined with each other or with other tables combining a multitude of layouts creating an attractive look. Tables are made of Medium-density fiberboard (MDF) covered by high-pressure laminate (HPL), with PVC edge banding. Legs are either fixed or adjustable to offer different heights, an advantage for mixed age groups.

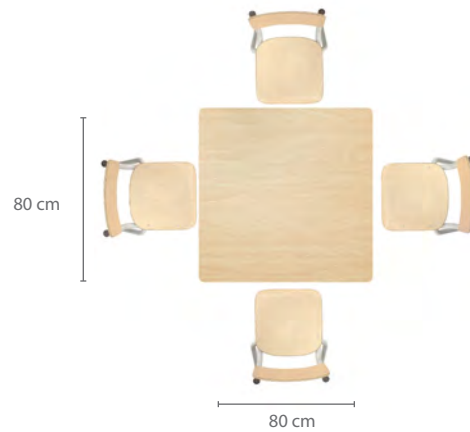
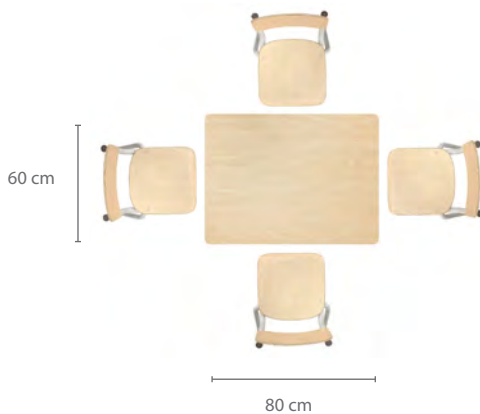
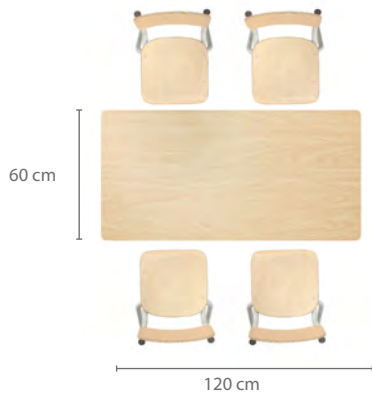

Stages & Symbol

- C01 - Toddler1 30 cm
- C02 - Toddler2 36 cm
- C0 - Nursery1 40 cm

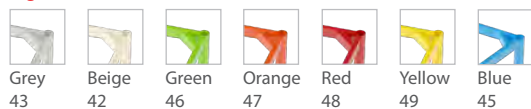

Table Top Option 22 mm MDF Laminated HPL solid beech edges

 Ultra Table 120x60 cm	C 01	44520
	C 02	44521
	C 0	44530
 Ultra Table 60x80 cm	C 01	44522
	C 02	44523
	C 0	47920
 Ultra Table ø120 cm	C 01	44524
	C 02	44525
	C 0	44542
 Ultra Table 80x80 cm	C 01	44526
	C 02	44527
	C 0	44650
 Ultra Table 60x60 cm	C 01	44528
	C 02	44529
	C 0	44611

● Please Select

Legs / Rails Colours



● Please Select

Table - Top Colours



Toddler

Kinder Tables

Robust solid tables that will last for generations. Kinder Tables come packed- flat for your convenience and they are easily assembled with the simple instructions provided. Tables come in 3 convenient heights and 4 functional shapes. Legs and rails are made of solid wood. Ideal for little children from one 1 to three 3 years. All tables can be produced in three options of tTable-tops as follows:

- Tabletop 22mm made from extremely strong medium density fibreboard (MDF) laminated with high pressure laminate (HPL). Edges made from solid beechwood with protective varnish. They are gently smoothed and lightly rounded to avoid any risk or injury.
- Tabletop 22mm made from extremely strong medium density fibreboard (MDF) laminated with high pressure laminate (HPL). Edges with protective varnish. They are gently smoothed and lightly rounded to avoid any risk or injury.
- Tabletop 22mm thickness made from massive solid bBeechwood (KD) – traditional wooden joints, using high quality European standard adhesive, (NAF) no added formaldehyde (NAF),. The tTop and eEdges painted with protective lacquer and varnish, with safe and gently and safety rounded edges.

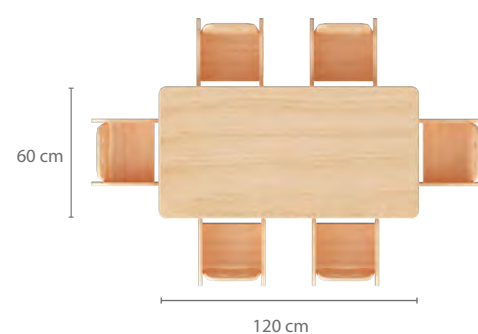
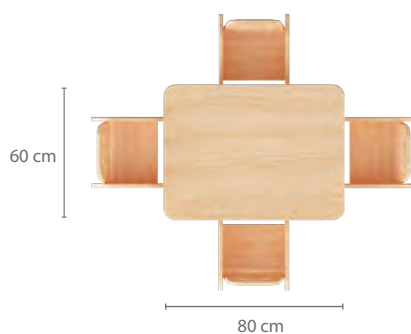
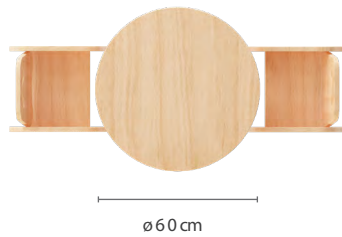



Table Top Option 22 mm MDF Laminated HPL solid beech edges







 kinder Table 80 x 60 cm	C 01	48063
	C 02	48064
	C 0	48065
 kinder Table 60 x 60 cm	C 01	48072
	C 02	48073
	C 0	48074
 kinder Table 80 x 80 cm	C 01	48050
	C 02	48051
	C 0	48052
 kinder Table 120 x 60 cm	C 01	48055
	C 02	48056
	C 0	48057
 kinder Table ø 60 cm	C 01	48081
	C 02	48082
	C 0	48083
 kinder Table ø 90 cm	C 01	48045
	C 02	48046
	C 0	48047

Table - Top Colours



Woody
11



Beige
12

Reading Centres

Reading centres provide a space for sharing, discussion, solitude and relaxation. The furniture and ambience need to reflect this to provide the perfect secure learning environment. Our reading centre furniture meets all these requirements. All units can be configured to your preferred layout design. We offer a truly functional system that allows growth with the needs of your organization.





Reading Centres

Mobile Book Browser Units

Each unit features easy-access bins for children to choose and pick books. Available in three 3 designs: two 2 bins, four 4 bins, four 4 bins with drawers. Supplied assembled.



35.6 x 45 x 37 cm **45152**



69.4 x 45 x 37 cm **45153**



Curved Storage Box Units

These smooth designed storage units are very helpful for reading corners. Its curved exterior and module design are ideal for making different corners depending on the space available. Supplied assembled.



91.8 x 36.9 x 81.6 cm

45150



Reading Centres

Double Sided Display Book Units

These units are double sided, which means you can display the books on either or both sides. There are 2 design options to choose from with drawers and without drawers. Units are suitable for books and magazines. Supplied assembled.



Available with Casters



80 x 40 x 100 cm

45157



80 x 40 x 60 cm

45158



Art Centres

The world around us is full of colours and shapes. Help children to appreciate their world and express their joy in a creative way. Our arts section aims to develop creativity, imagination, and a gives the children a solid grasp of colour and shapes.





Art Centres

Equipment trolley

This multi-function storage trolley is ideal for all organizing all materials and resources. It is equipped with shelves, plastic trays and wooden trays, which allows storage of art and crafts materials. Casters can be added to give the ability to move resources from area to area. Made of high quality MDF.



With or without casters **99697**
Height with casters + 12 cm



69 x 40 x 71 cm

64037



80 x 40 x 92 cm

64102

Island unit



80 x 40 x 71 cm

64104

Island unit



80 x 40 x 71 cm

64103



Art Centres

Easel

A top- quality easels that are perfect for art and& craft classrooms. They fold flat for compact easy storage, and they also come optionally with plastic drawers for organizing art supplies. It can be used from both sides. Heavy-duty lockable castoers are included for easy movement.



Double sided easel

41 x 5 x 95 cm

21505



Double Sided Metal Easel with Trays

108 x 42 x 140 cm

21520



Double Sided Wooden Easel with Trays

70 x 45 x 120 cm

21521



Drama Centres

Imagination, going shopping, having a tea party for a favourite toy are some of the best activities children can have. Some children have interpersonal intelligence, which means they are sensitive to others' moods, feelings, temperaments and motivations, and their ability to cooperate in order to work as part of a group. This section helps to enhance interpersonal intelligence for children who need to break down walls of shyness and help those who have it already to excel with it, as they role play different characters.





Drama Centres

Children Play Kitchen

Our natural look kitchen set will make your home corner the most attractive in town! In this kitchen set we have combined play value with the highest quality, durability and, of course, value for money. There are 3 units in this set (Cooker/oven - Sink / Washing Machine - Fridge). All units are constructed from quality lacquered beechwood, which has a tough protective finish. It is designed to withstand even the most boisterous environment.



35 x 40 x 85 cm **21625**



35 x 38.5 x 52 cm **21626**



35 x 38.5 x 52 cm **21627**



112.5 x 40 x 105 cm **21660**



Drama Centres

Role play Clothes Rack

This beautiful natural look child-size clothes rack will keep the children happy for hours, super role-playing fun! It can be folded flat for storage. Compatible with the iron set.



21571
L 55.3 X W 34 X H 55.3 cm



21570
Fun Pretend Clothes Rack
Size : 55.3 X 34 X 55.3 cm

Role play Iron Set

This natural looking ironing set has been specially designed to be true to life. Little ones adore role play and pretending and can this keep them happy for hours. It comes with a wooden iron and ironing board that can be folded flat for storage.



21566
Iron 16.4 x 10.3 x 10 cm
Iron table 82.5 x 28 x 55 cm



21565
Fun Pretend Iron Set
Iron Size : 16.4 x 10.3 x 10 cm
Iron table Size : 82.5 x 28 x 55 cm



Drama Centres

Children's lounge

This high-quality lounge setting is an attractive addition to preschool classrooms or role play areas. Frames are manufactured from natural solid wood. Back and seat cushions are made from high density fibre covered with either fabric or leather covering. It encourages social interaction for children as they sit on the lounge during play or when reading books. It is a timeless design that will create a warm and inviting atmosphere.





43906
Lounge sofa
Lounge chair
Lounge table



Lounge sofa
89 x 52 x 60 cm **43907**



Lounge chair
49 x 52 x 60 cm **43908**



Lounge table
60 x 45 x 40 cm **43909**

Available Colours.



Red
76



Mid Red
77



Dark Red
78



Ligth Purple
79



Purple
88



Dark Purple
89



Mid Blue
90



Blue
91



Dark Blue
92



Beige
93



Dark Beige
94



Dark-Brown
95



Gray
96



Dark Gray
97

Drama Centres

Fantasy dress-up unit

Children just love playing dress up, it is so much fun! This dress-up unit has 10 hooks for costumes, a top shelf for hats or smaller items, and 3 plastic transparent trays in the base. Heavy-duty castors included for mobility. Full-length acrylic mirrors on both ends. It is a timeless piece of furniture addition for any pre-schools or activity centres.

45820

Size : 103 x 45 x 120 cm



Activity Play Table

These tables are designed especially for play. The stand-up working height makes them perfect for playtime. Its colourful landscape mat was is built to last. Curved edges for safety. Transparent plastic drawers for easy storage for toys. It can be used from all sides for group play.

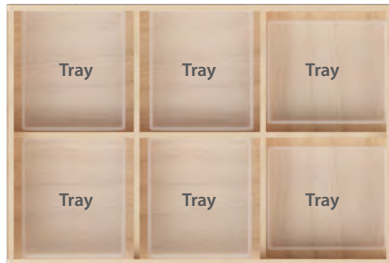

Plastic Trays



116 x 78 x 50 cm **45188**



75 x 75 x 34 cm **45189**



116 x 78 x 34 cm **45187**



75 x 75 x 50 cm **45190**

Edu Fun website

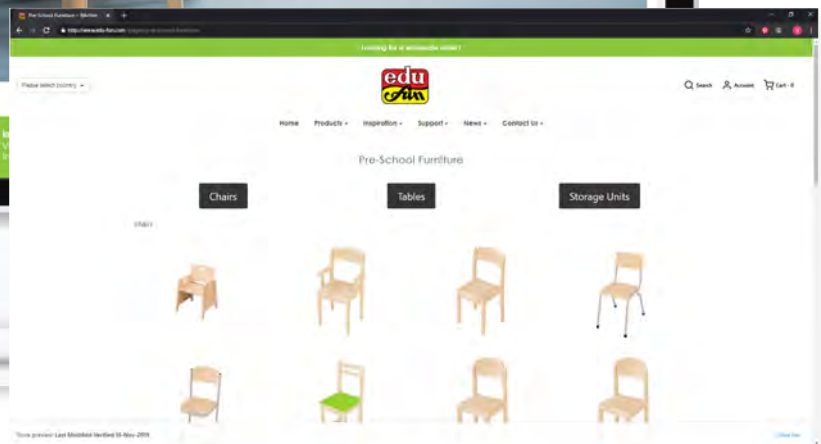
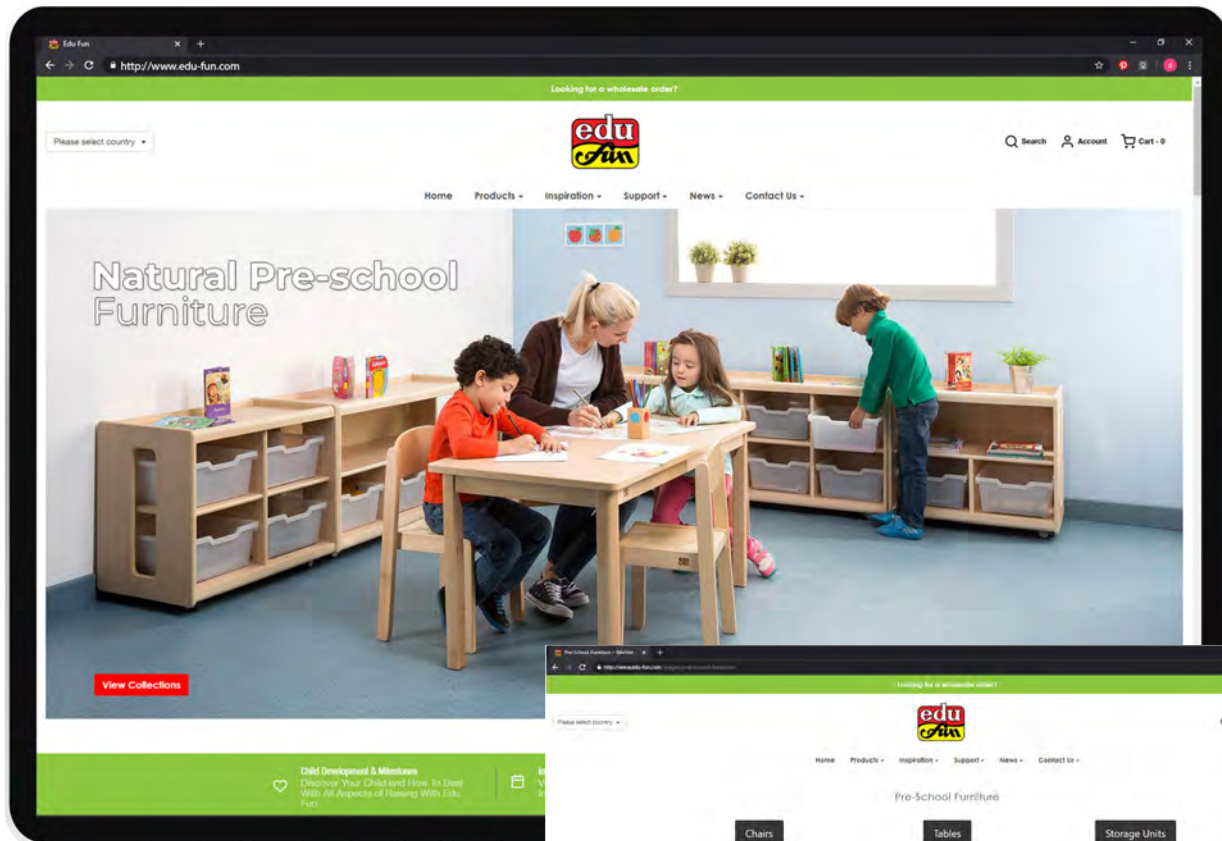

Visit our website
www.edu-fun.com





■ **Head Office**
Australia & Oceania Sales Office
Edu fun® Pty Ltd
Australia

- Marketing & Sales Office
- Warehouse

1 Envision Close , 19 Corporate terrace
 Pakenham, Victoria 3810,
 Australia
 Tel.: 1300-EDUFUN
 Tel: + 61 402 266 852
 Email: aus@edu-fun.com
 web: www.edu-fun.com.au

■ **Europe Sales Office**
Edu fun® GmbH
Deutschland

- Showroom & Outlet
- Marketing & Sales Office
- Warehouse

Neuried Ichenheim - Germany
 Rheinstrasse 7 - 77743 Neuried
 Tel.: +49 [0]7807 / 0000
 Fax: +49 [0]7807
 e-mail: info@edufun.de
 web: www.de.edu-fun.com

■ **& Edu fun® Middle East Sales Office**
Dubai -UAE

- Showroom & Outlet
- Marketing & Sales Office
- R&D Department
- Warehouse& workshop

No.1, ASAS Building, Maliha Rd
 Industrial Area 18, Sharjah, UAE
 Tel.: +971 6 556 8255, Fax: +971 6 556 8334
 Cell: +971 50462 2134,
 e-mail: uae@edu-fun.com
 web: www.ae.edu-fun.com

■ **MENA Region Sales Office**
Edu fun® MENA
Egypt

- Showroom & Outlet
- Production Facilities
- Technical & OEM Office
- Marketing & Sales Office
- Warehouse

No. 27 Mohammed Tawfik Diab
 Makram Ebied, Nasr City
 Cairo, Egypt
 Tel.: + 202 227 07 649
 Fax: + 202 227 07 571
 Email: egypt@edu-fun.com
 web: www.eg.edu-fun.com



**Head Office
Australia**

1 Envision Close , 19 Corporate terrace
Pakenham, Victoria 3810, Australia

Tel.: 1300-EDUFUN

Tel: + 61 402 266 852

Email: aus@edu-fun.com

web: www.edu-fun.com.au