



# Furniture for **Early Learning Spaces**



**Catalogue 2024 - 2025**

# CONTENTS



**Introduction** 04

**Harmony Line** 14

Elegance Tables 22

Chairs 40

- Deluxe - Elegance

**Prime Line** 46

Flexo Tables 50

Chairs 54

- Simple - New Simple

**Stool & Benches** 62

**Toddler** 68

Tables 72

Chairs 82

Soft seating 88



<b>Teacher Furniture</b>	<b>92</b>
Tables	94
Chairs	98
Soft seating	106
<b>Storage Units</b>	<b>110</b>
Ultimate N	118
<b>Reading Centres</b>	<b>132</b>
<b>Dividers</b>	<b>140</b>
<b>Soft Play</b>	<b>152</b>
Small Soft Play	154
Large Soft Play	156
<b>Soft Seating</b>	<b>160</b>
<b>Drama Centres</b>	<b>168</b>
Kitchen	170
Iron Set & Cloth Rack	174
Children's lounge	176



## Crafting Excellence

Edu Fun's 25-Year Journey in Premium Pre-School Furniture  
Welcome to the world of Edu Fun, where years of unwavering dedication and innovation have introduced quality products that helped shape better early learning environments. Our commitment to excellence drives us.

Born in 1996 in Nuremberg, Germany, Edu Fun set out with a mission to create thoughtfully designed, functional, and safe furniture for young learners. Rooted in European design standards and premium materials, our influence has expanded globally, incorporating unmatched craftsmanship into our overseas production.

Edu Fun has evolved into a globally recognized group of companies, operating from multiple locations and specializing in designing, producing, and exporting pre-school educational furniture and early learning resources

What Makes Edu Fun Stand Out for Your Early Learning Environment Needs:

- **Premium European Natural Materials:**  
Safety and durability are paramount. We use natural wood from Top-Quality European forests, meeting stringent safety standards and complying with European standards.
- **European Design Excellence:**  
Inspired by European aesthetics, our pieces harmonize elegance, simplicity, and functionality to foster an inspiring learning environment, adhering to European design standards.
- **Comprehensive Age Range:**  
Our products support diverse age groups, aiding every stage of early childhood development while conforming to European safety standards.
- **Flexible Furniture Solutions:**  
Our furniture seamlessly adapts to various spaces, room sizes, and age groups, offering unparalleled flexibility while complying with European safety and quality norms.
- **Tailored Solutions:**  
Customization options are available to precisely align with your specific needs, transforming educational spaces according to your vision while meeting European safety standards.
- **Expertise Designers and Craftsmen from Europe:**  
Our International Expertise Designers and Craftsmen bring European expertise and traditions to our manufacturing process, ensuring compliance with European standards throughout the production cycle.
- **Affordable Overseas Production:**  
Through a strategic partnership with an established overseas school furniture factory, we maintain competitive pricing without compromising quality, adhering to European safety and quality regulations.
- **Multi-Regional Distribution Centres**  
Edu Fun's product ranges are easily accessible through regional distribution centres and exclusive agents. The four main distribution centres, equipped with available stock, experienced sales teams, showrooms, and comprehensive after-sales services, are strategically located. Authorized agents in key markets further enhance the sales experience. Contact Edu Fun for the nearest distribution centres or authorized agents.

With over 25 years of experience, Edu Fun has earned trust as a reliable supplier of thousands of products in numerous international markets. Explore our extensive catalogue, connect with our team, and join us in crafting secure, captivating, and inspiring educational environments for young learners.

Thank you for considering Edu Fun. We eagerly await the opportunity to assist you in creating enhanced learning spaces.







1996



2024

## From Forest to Classroom

At EduFun®, we are proud to offer our customers the best products made of the highest quality materials. We exclusively use high-quality natural wood sourced from European forests, primarily solid beech wood and birch plywood, to create our furniture and learning resources. We oversee our wood sourcing and control the process from log preparation, wood treatment and kiln drying, ensuring a comprehensive approach to quality. We believe our commitment to quality and attention to detail differentiates us from our competitors. This enables us to provide competitive prices by managing the entire production process.







## Manufacturing

EduFun® has always been a designer and manufacturer of its diverse product range. We maintain complete control over our productions from the design stage to shipping. With Edu Fun's five production lines, we offer a wide range of products for early learning environments.

We have continually expanded our production lines to meet growing demand, concurrently expanding the collections within the EduFun® range to satisfy customer preferences. New state-of-the-art machines have been integrated into our production lines, ensuring quality and timely production.

EduFun® 5 Production Lines:

1. Solid Wood Production Line
2. Panel Board Production Line
3. Tube Bending Production Line
4. Upholstery Production Line
5. Learning Resources, Wooden Toys, and Puzzles Production Line.

With these production lines, EduFun® is able to provide a vast product range that caters to the trends and needs of early learning environments. Additionally, EduFun® offers OEM products tailored to our customers' designs and preferences.



## International Standards

### Products Standards

Our furniture collections comply with European standards for chairs and tables in educational institutions EN 1729. Edu Fun chairs and tables are made to accommodate different body heights, ensuring they are ergonomically designed for active children in their early years, promoting good posture and preventing problems or distortions as children grow. We are proud to meet the BS EN 1729 1&2 standards.

**BS EN 1729 1**

**BS EN 1729 2**

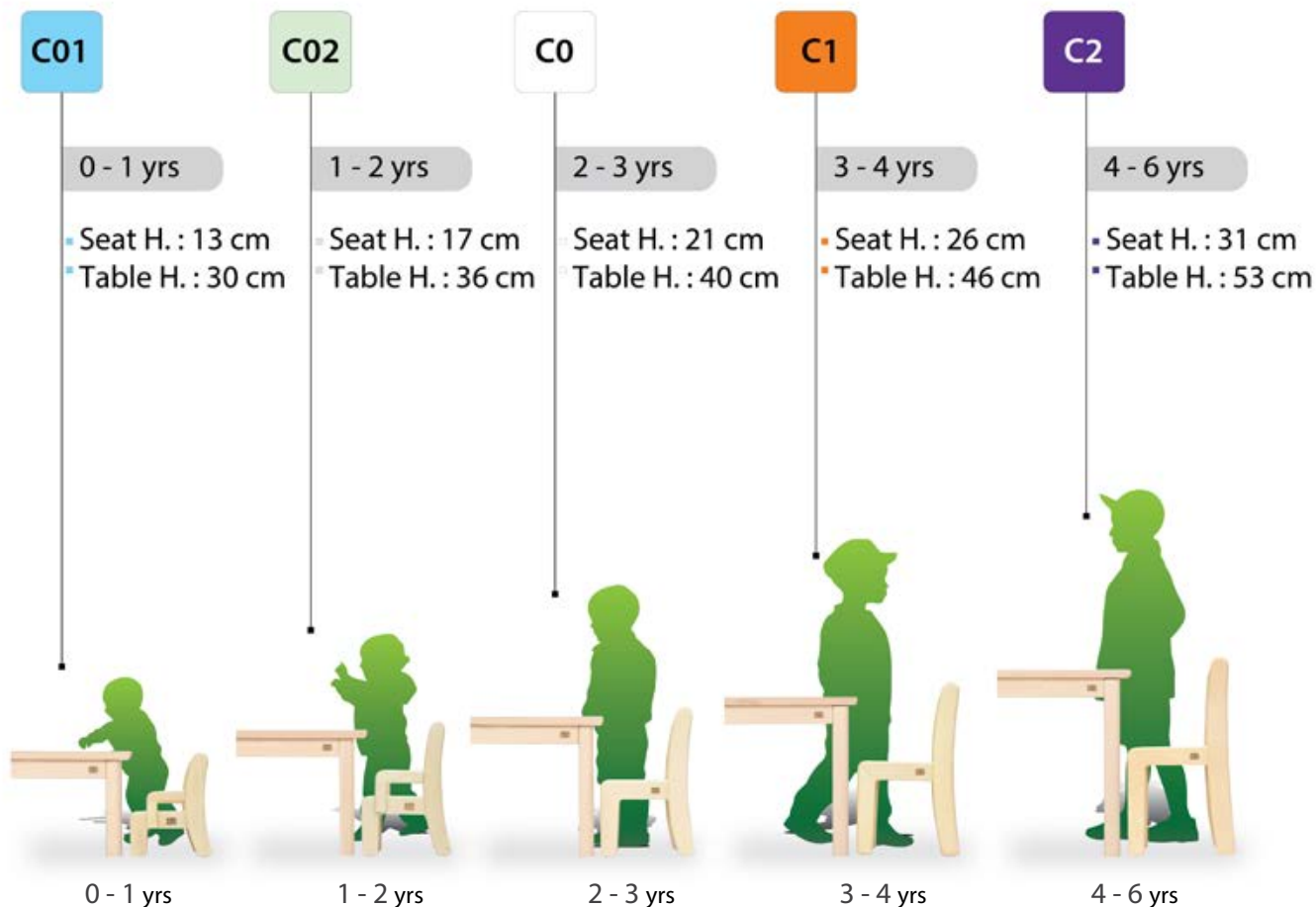
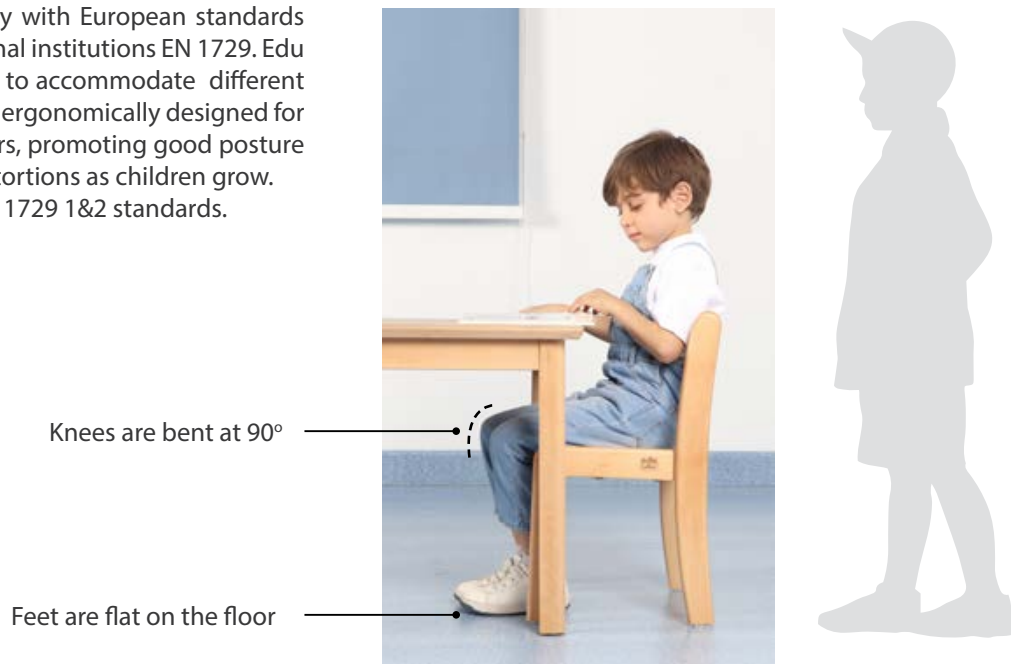





## International Standards

Quality, safety & environments standards  
 At EduFun®, we prioritize the health and safety of children, which is why we ensure that all of our products and production facilities meet the latest international standards for safety. Our products are certified to meet standards such as  
 BS EN 1729  
 ANSI/BIFMA  
 ISO 9001  
 ISO 14001  
 OHSAS 18001



**BS EN 1729**  
 For dimensions



ISO 9001  
 ISO 14001  
 OHSAS 18001

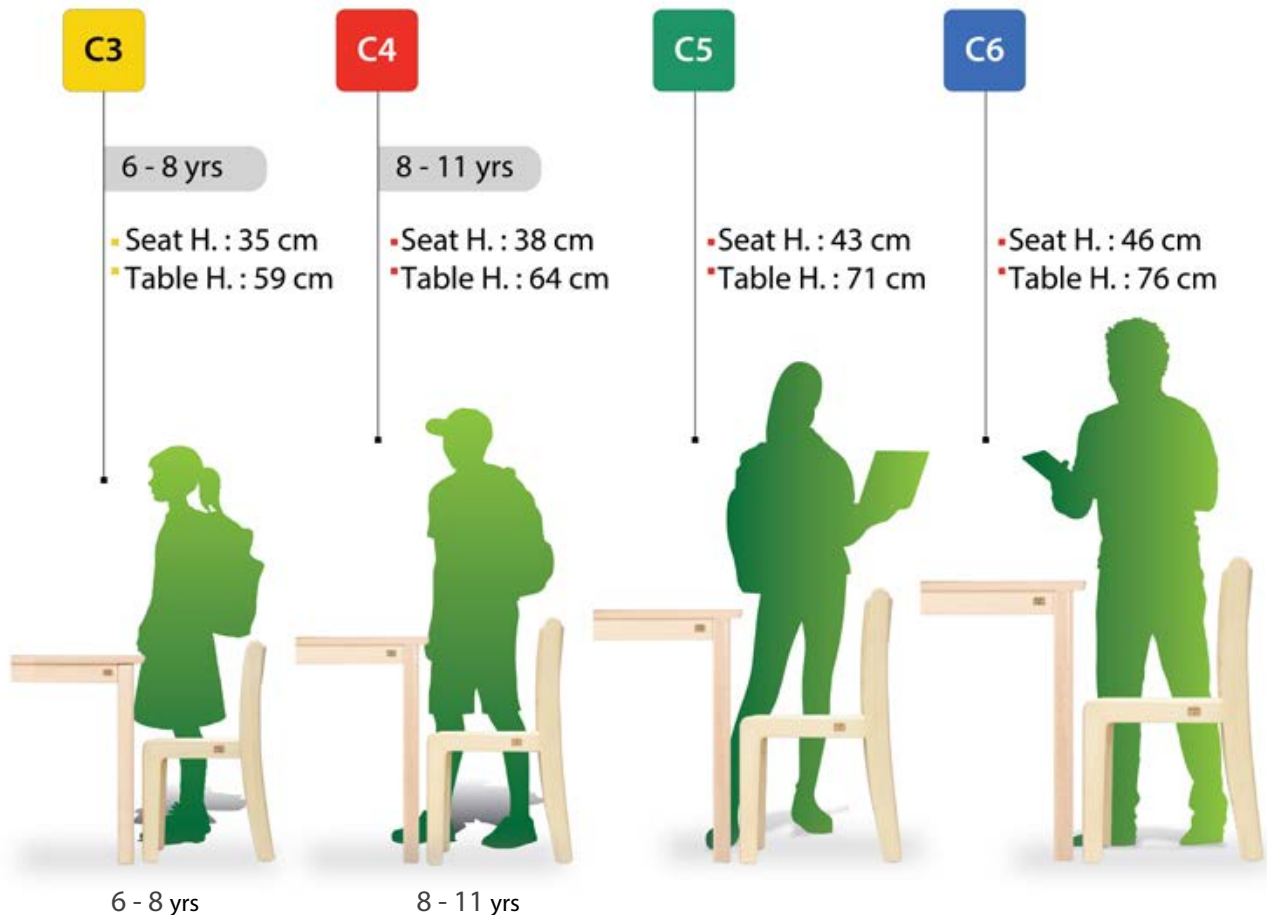

# Introduction

## Crafting Designs

EduFun® products ranges are created by our expert in-house research, design, and development team or in collaboration with renowned international design partners.

Our designers prioritize European Design Excellence, emphasizing elegance, simplicity, and functionality while ensuring strict compliance with international design regulations and safety standards.

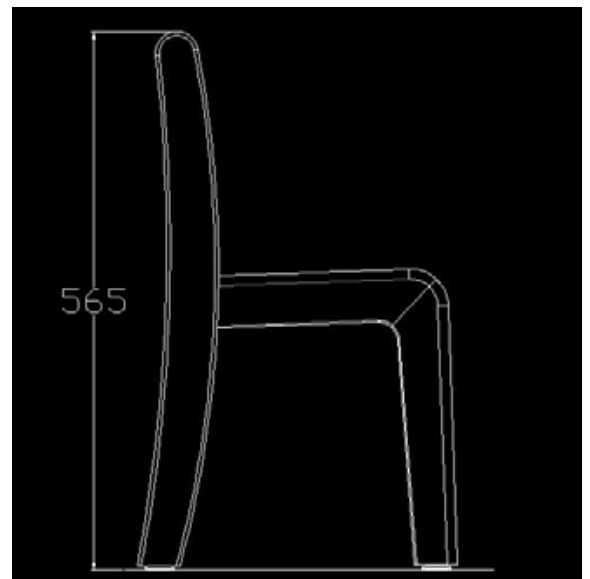
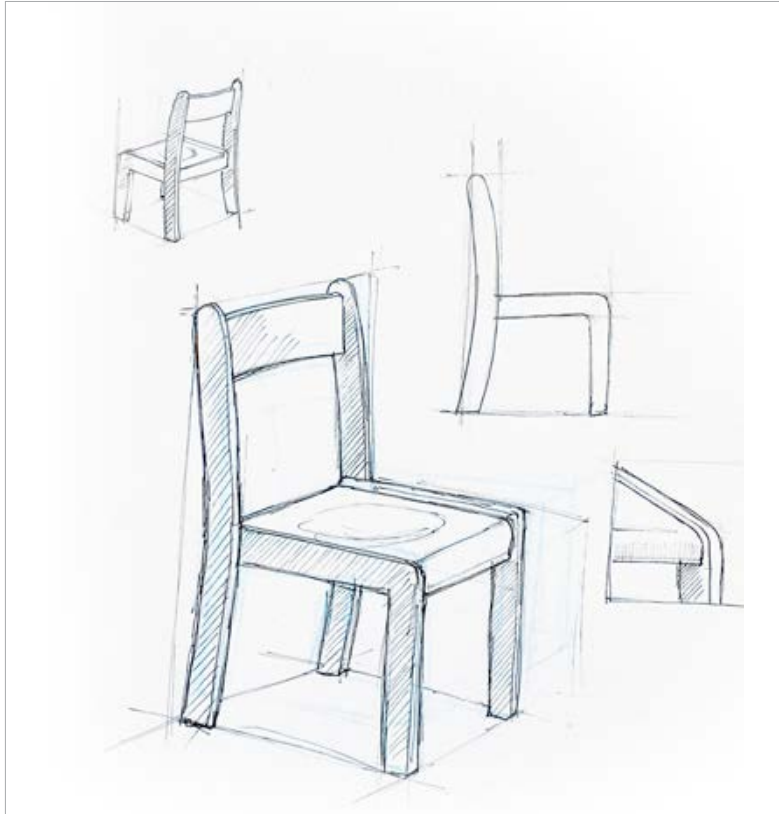

**Reyer Kras**  
Netherlands



**Andreas Bluth**  
Spain



**Peggy Bannenberg**  
Netherlands



**Emma Labahn**  
Germany

## Product Details

When designing and manufacturing Edu Fun product ranges, we pay meticulous attention to details with a focus on crafting excellence. A few examples include:

- Multi-height options for all age groups
- stackable design
- Ergonomic design
- Anti-tipping leg design
- Strong wood connections
- Safe round edges according to European standard
- Ready assembled, solid , strong no-screw products
- Plastic glides for leg protection





## Multi-Regional Distribution Centres

Edu Fun's product ranges are easily accessible through regional distribution centres and exclusive agents. The three main distribution centres are strategically located with available stock, experienced sales teams, showrooms and comprehensive customer service. Authorised agents in key markets further enhance the customer experience. Contact Edu Fun for the nearest distribution centres or authorised agents.

EduFun® Distributors:  
Europe & America  
Australia & Asia  
Middle East & Africa







## Harmony Line

### Natural European Beechwood

#### The Classic Natural European Wood Series:

- Ergonomically European designed series.
- Solid European beech wood chairs and table frames.
- Natural European birch plywood seat and back rest.

Our Harmony Line is designed with natural European beechwood and features ergonomically designed chairs and tables. The classic natural European wood series is constructed with solid European beechwood frames and natural European birch plywood seat and backrest. The Harmony Line offers a wide range of products that can help create a natural and efficient learning environment. With its modular design, the natural look of our furniture can be transformed into creative expressions, offering infinite arrangements and possibilities.

#### Tables:

- Tops are made from 22 mm thick MDF (Medium Density Fiberboard) and laminated with HPL (High Pressure Laminate) with high scratch and shock resistance surfaces.
- New designed solid wood edges, curved and rounded for safety, with no grooves when tables are grouped or combined.
- Varnished solid beech wood edges, curved and rounded for safety are available in wood grain and beige colors.
- Comes with a 5 year guarantee. Table frame made from varnished solid beechwood with rounded corners (according to European standards).
- Legs are fitted with glides to provide floor leveling and reduce noise. Legs come unassembled and can be easily fixed to the table tops frame using a strong metal fixing bracket.

#### Chairs:

- Frames are made from European beechwood.
- Seat and backrest are made from curved multilayered birch plywood.
- Comes assembled.
- Multi-stack chairs with a wide range of seat and backrests available in natural or colored range.
- Legs have a glide to protect floors and reduce noise.
- Strong enough to hold the weight of an adult.
- Comes with a 5 year guarantee.









We suggest the Elegance Table with the Elegance Chair or Deluxe Chair as the main choice in the harmony line. Any wooden chair - from our collection - can also be used with our Elegance Table. (Page 16 to 29).



● Elegance Table



● Deluxe Chair



● Elegance Chair

● Please Select  
Legs / Rails Colours



Natural plywood  
01

● Please Select  
Table - Top Colours



Woody  
11



Grey  
13



White  
14

Seat & back colours with wooden frame



● Natural plywood  
01-01





## Table combination

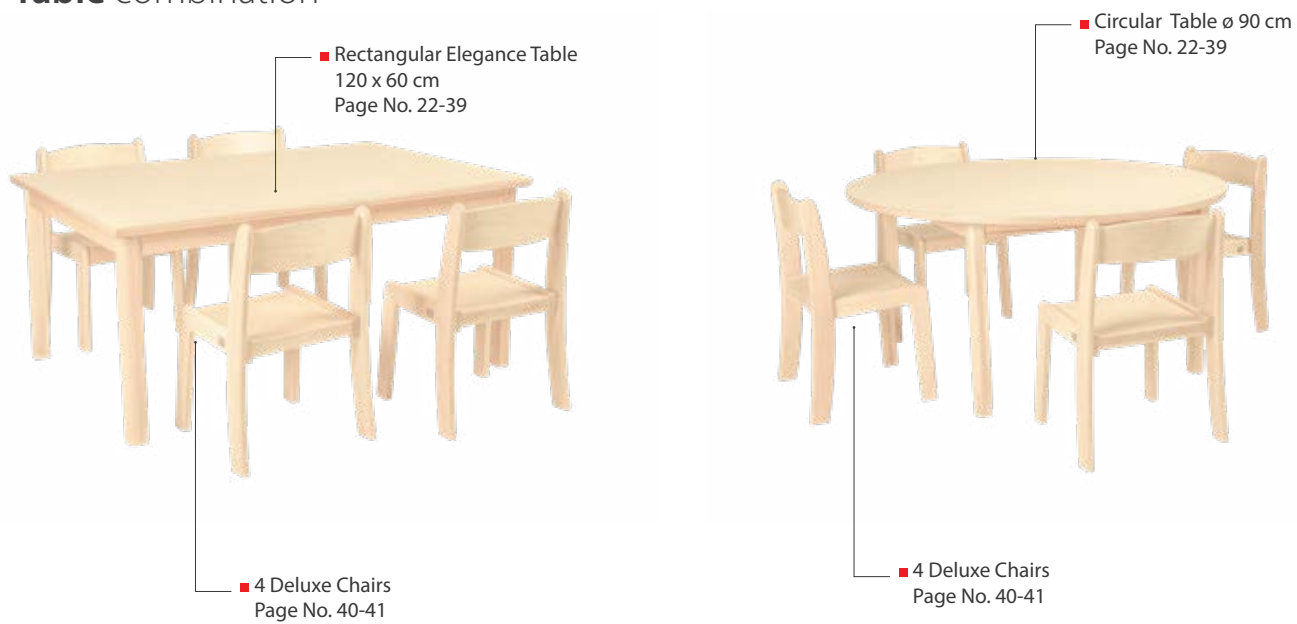

## Another shapes of Elegance Tables





## Elegance Tables

Our Elegance Table line is shipped in a flat-pack for your convenience. Assembly is simple with the included instructions. The finished product is solid, stable, and durable. The tables come in different heights and shapes, and are modular and can be arranged in various configurations. The legs are made from solid wood. Plastic glides or coasters can be added upon request. The table tops are 22mm thick, made from MDF and laminated with HPL. The edges are made from solid beechwood with a protective varnish, smoothed and lightly rounded for safety.

- Supplied unassembled



Table tops and legs are sold separately, allowing for flexibility and efficient inventory management. Any leg height can be paired with any tabletop shape.

## 22mm MDF Laminated with HPL Solid Beech Edges

Tabletops that are 22mm thick are made from extremely strong medium density fiberboard (MDF) that is stiff, knot-free, and has smooth edges. The tops are laminated with high-pressure laminate (HPL) using heat (80-90 Celsius) and pressure (250 kgs/m<sup>2</sup>). No added formaldehyde (NAF). Available in beige or white or gray wood-themed colors. Edges made from solid beechwood and coated with protective varnish, featuring smooth and rounded edges for safety.



A Special rounded Edge design without spacing when tables are grouped (shark nose Edges)

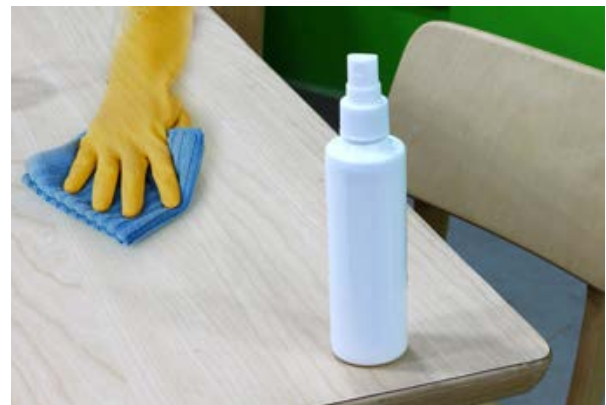

Easy to clean

## HPL vs. Melamine

High Pressure Laminate (HPL) is commonly referred to as HPL and is manufactured under 1,000 kg/m<sup>2</sup> of pressure, pressing down on 6 to 8 layers of kraft paper bonded with phenolic resin glue and topped by a polymer facing. It is used in applications such as bench-tops, joinery, wall paneling, lockers, and tables where scuff resistance is prominent and important.

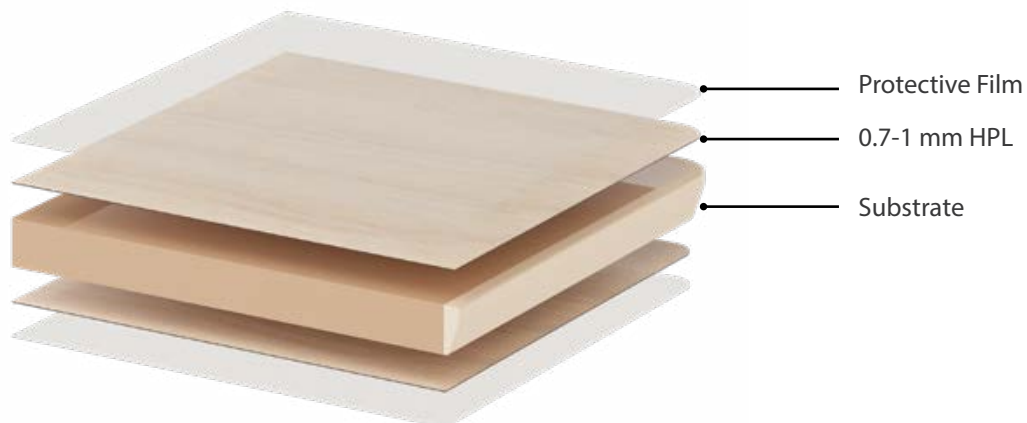

When you purchase HPL sheets, they are generally not attached to a substrate such as MDF or craft wood. Attaching it to a timber substrate is a separate process commonly referred to as “laying up the laminate”. For best results, it should be attached to a dense substrate, such as moisture-resistant Medium Density Fiberboard (MDF), and combined with ABET High-Pressure Laminates for the decorative surface. This results in the best possible finish with maximum durability.

# Harmony Line

## Elegance Tables

### Wooden Legs

There are 7 different heights for these wooden legs, which are convenient for children of different heights. The tables come packed flat for convenience and are easily assembled with the simple manual instructions provided.



Connection



Easy to assemble



Available with or without Casters



Glides



Rounded Edges

### Table Heights

- C4 64 cm
- C3 59 cm
- C2 53 cm
- C1 46 cm
- C0 40 cm
- C02 36 cm
- C01 30 cm







## Rectangular Elegance Table

160 x 80 cm



Table combination



● Please Select

Complete table	Table Component	C0	C1	C2	C3	C4
    Rectangular Table 160 x 80 cm	 Table -Top with wooden frame 160 x 80 cm	69933				
	 Elegance Table legs ( 4 legs set only)	69970	69971	69972	69973	69974
	 Elegance Table legs ( two w/ casters,two w/o casters )	69977	69978	69979	69980	69981

● Please Select  
Legs / Rails Colours

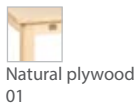

● Please Select  
Table - Top Colours



# Rectangular Elegance Table

120 x 80 cm



Table combination

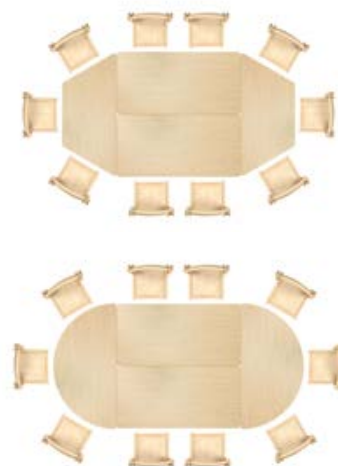

● Please Select

Complete table	Table Component	C0	C1	C2	C3	C4
    Rectangular Table 120 x 80 cm	 Table -Top with wooden frame 120 x 80 cm	69919				
	 Elegance Table legs ( 4 legs set only)	69970	69971	69972	69973	69974
	 Elegance Table legs ( two w/ casters,two w/o casters )	69977	69978	69979	69980	69981

● Please Select  
Legs / Rails Colours



Natural plywood  
01

● Please Select  
Table - Top Colours



Woody  
11



Grey  
13



White  
14



## Rectangular Elegance Table

120 x 60 cm



Table combination



● Please Select

Complete table	Table Component	C0	C1	C2	C3	C4
  Rectangular Table 120 x 60 cm	 Table -Top with wooden frame 120 x 60 cm	69921				
	 Elegance Table legs ( 4 legs set only)	69970	69971	69972	69973	69974
	 Elegance Table legs ( two w/ casters,two w/o casters )	69977	69978	69979	69980	69981

● Please Select  
Legs / Rails Colours

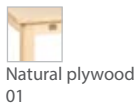

● Please Select  
Table - Top Colours



# Rectangular Elegance Table

80 x 60 cm



Table combination



● Please Select

Complete table	Table Component	C0	C1	C2	C3	C4
  Rectangular Table 80 x 60 cm	 Table -Top with wooden frame 80 x 60 cm	69920				
	 Elegance Table legs ( 4 legs set only)	69970	69971	69972	69973	69974
	 Elegance Table legs ( two w/ casters,two w/o casters )	69977	69978	69979	69980	69981

● Please Select  
Legs / Rails Colours



Natural plywood  
01

● Please Select  
Table - Top Colours



Woody  
11



Grey  
13



White  
14

## Trapezoidal Elegance Table

120 x 52 cm



Table combination



● Please Select

Complete table	Table Component	C0	C1	C2	C3	C4
    Trapezoidal Table 120 x 52 cm	  Table -Top with wooden frame 120 x 52 cm	69926				
	  Elegance Table legs ( 4 legs set only)	69970	69971	69972	69973	69974
	  Elegance Table legs ( two w/ casters,two w/o casters )	69977	69978	69979	69980	69981

● Please Select  
Legs / Rails Colours

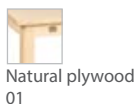

● Please Select  
Table - Top Colours







## U-Shape Elegance Table 180 x 120 cm



Table combination



● Please Select

Complete table	Table Component	C0	C1	C2	C3	C4
	<p>Table -Top with wooden frame 180 x 120 cm</p>	69927				
<p>U-Shape Table 180 x 120 cm</p>	<p>Elegance Table legs ( 6 legs set only)</p>	69800	69801	69802	69803	69804
	<p>Elegance Table legs ( four w/ casters,two w/o casters)</p>	69810	69811	69812	69813	69814

● Please Select  
Legs / Rails Colours

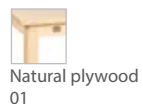

● Please Select  
Table - Top Colours

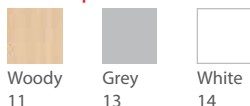

# U-Shape Elegance Table

150 x 100 cm



Table combination



● Please Select

Complete table	Table Component	C0	C1	C2	C3	C4
    U-Shape Table 150 x 120 cm	 Table -Top with wooden frame 150 x 100 cm	69931				
	 Elegance Table legs ( 6 legs set only)	69800	69801	69802	69803	69804
	 Elegance Table legs ( four w/ casters,two w/o casters )	69810	69811	69812	69813	69814

● Please Select  
Legs / Rails Colours

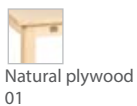

● Please Select  
Table - Top Colours













## Circular Elegance Table

ø 120 cm

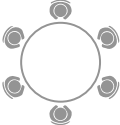

● Please Select

Complete table	Table Component	C0	C1	C2	C3	C4
  Circular Table ø 120 cm	 Table -Top with wooden frame ø 120 cm	69930				
	 6 Wooden legs	69800	69801	69802	69803	69804
	 4 Wooden legs & 2 Wooden legs With Casters	69810	69811	69812	69813	69814

● Please Select  
**Legs / Rails Colours**

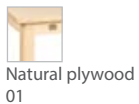

● Please Select  
**Table - Top Colours**





# Circular Elegance Table

ø 120 cm



● Please Select

Complete table	Table Component	C0	C1	C2	C3	C4
<p>Circular Table ø 120 cm</p>	<p>Table -Top with wooden frame ø 120 cm</p>	69922				
	<p>Elegance Table legs (4 legs set only)</p>	69970	69971	69972	69973	69974
	<p>Elegance Table legs (two w/ casters, two w/o casters)</p>	69977	69978	69979	69980	69981

● Please Select  
Legs / Rails Colours



Natural plywood  
01

● Please Select  
Table - Top Colours



Woody  
11



Grey  
13



White  
14

# Harmony Line

## Circular Elegance Table

ø 90 cm



● Please Select

Complete table	Table Component	C0	C1	C2	C3	C4
 Circular Table ø 90 cm	 Table -Top with wooden frame ø 90 cm	69923				
	 Elegance Table legs ( 4 legs set only)	69970	69971	69972	69973	69974
	 Elegance Table legs ( two w/ casters,two w/o casters )	69977	69978	69979	69980	69981

● Please Select  
Legs / Rails Colours

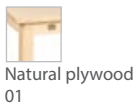

● Please Select  
Table - Top Colours

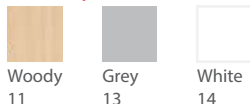

# Smi-Circular Elegance Table





120 x 60 cm



Table combination



● Please Select

Complete table	Table Component	C0	C1	C2	C3	C4
    SMI-Circular Table 120 x 60 cm	 Table -Top with wooden frame 120 x 60 cm	69924				
	 Elegance Table legs ( 4 legs set only)	69970	69971	69972	69973	69974
	 Elegance Table legs ( two w/ casters,two w/o casters )	69977	69978	69979	69980	69981

● Please Select  
Legs / Rails Colours



Natural plywood  
01

● Please Select  
Table - Top Colours



Woody  
11



Grey  
13



White  
14







## Square Elegance Table 80 x 80 cm

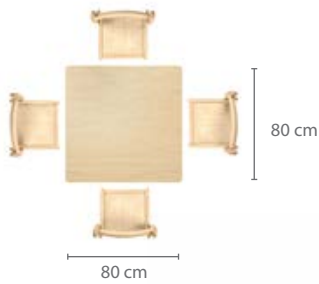





Table combination



● Please Select

Complete table	Table Component	C0	C1	C2	C3	C4
    Square Table 80 x 80 cm	 Table -Top with wooden frame 80 x 80 cm	69928				
	 Elegance Table legs ( 4 legs set only)	69970	69971	69972	69973	69974
	 Elegance Table legs ( two w/ casters,two w/o casters )	69977	69978	69979	69980	69981

● Please Select  
Legs / Rails Colours

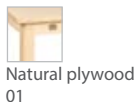

● Please Select  
Table - Top Colours



# Square Elegance Table

60 x 60 cm

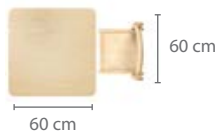





Table combination



● Please Select

Complete table	Table Component	C0	C1	C2	C3	C4
 Square Table 60 x 60 cm	 Table -Top with wooden frame 60 x 60 cm	69929				
	 Elegance Table legs ( two w/ casters,two w/o casters )	69970	69971	69972	69973	69974
	 Elegance Table legs ( two w/ casters,two w/o casters )	69977	69978	69979	69980	69981

● Please Select  
Legs / Rails Colours



Natural plywood  
01

● Please Select  
Table - Top Colours



Woody  
11



Grey  
13



White  
14



# Harmony Line

## Deluxe Chair

An ergonomic chair that will last for generations. This chair is made of solid, top-quality lacquered beechwood and plywood. There are five different heights to accommodate children of different ages. The chairs can be stacked to save space and are available with arms.



Ergonomic seat



Ergonomic backrest



Soft Edges



Arm



Protective Glides

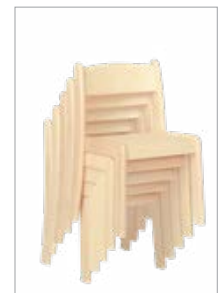

Stackable



Chairs & Tables	Seats Size	Chairs Code	Recommended Tables Height
<b>C0</b>	21 x 22.5 cm - H. 21 cm	<b>43304</b>	40 cm
<b>C1</b>	24 x 25 cm - H. 26 cm	<b>43303</b>	46 cm
<b>C2</b>	28 x 28 cm - H. 31 cm	<b>43302</b>	53 cm
<b>C3</b>	32 x 32 cm - H. 35 cm	<b>43301</b>	59 cm
<b>C4</b>	34 x 34 cm - H. 38 cm	<b>43300</b>	64 cm



● Natural plywood  
01-01

Chairs & Tables	Seats Size	Chairs Code	Recommended Tables Height
<b>C0</b>	21 x 22.5 cm - H. 21 cm	<b>43305</b>	40 cm
<b>C1</b>	24 x 25 cm - H. 26 cm	<b>43306</b>	46 cm
<b>C2</b>	28 x 28 cm - H. 31 cm	<b>43307</b>	53 cm
<b>C3</b>	32 x 32 cm - H. 35 cm	<b>43308</b>	59 cm
<b>C4</b>	34 x 34 cm - H. 38 cm	<b>43309</b>	64 cm



● Natural plywood  
01-01

with separated arm rest



How to order ——— Chair Code - Chair Seat & back colours with wooden frame Code — **43270 - 07 - 01**

## Elegance Chair

These beautifully crafted, stackable chairs would look great in any classroom. Each chair is made of solid, top-quality, lacquered beechwood and is built to last. Five convenient seat heights are available to correspond with our Elegance tables. Also the chairs are available with arms.



Ergonomic seat



Ergonomic backrest



Soft Edges



Protective Glides



Arm

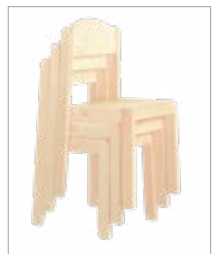

Stackable up to 4

Chairs & Tables	Seats Size	Chairs Code	Recommended Tables Height
<b>C0</b>	21 x 22.5 cm - H. 21 cm	<b>43201</b>	40 cm
<b>C1</b>	24 x 25 cm - H. 26 cm	<b>43202</b>	46 cm
<b>C2</b>	28 x 28 cm - H. 31 cm	<b>43203</b>	53 cm
<b>C3</b>	32 x 32 cm - H. 35 cm	<b>43204</b>	59 cm
<b>C4</b>	34 x 34 cm - H. 38 cm	<b>43205</b>	64 cm



● Natural plywood  
01-01

Chairs & Tables	Seats Size	Chairs Code	Recommended Tables Height
<b>C0</b>	21 x 22.5 cm - H. 21 cm	<b>43206</b>	40 cm
<b>C1</b>	24 x 25 cm - H. 26 cm	<b>43207</b>	46 cm
<b>C2</b>	28 x 28 cm - H. 31 cm	<b>43208</b>	53 cm
<b>C3</b>	32 x 32 cm - H. 35 cm	<b>43209</b>	59 cm
<b>C4</b>	34 x 34 cm - H. 38 cm	<b>43210</b>	64 cm

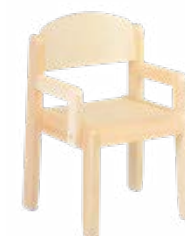

● Natural plywood  
01-01

with separated arm rest



How to order ——— Chair Code - Chair Seat & back colours with wooden frame Code — **43270 - 07 - 01**



## Classroom **Fit-Outs**

We offer custom-designed room plans to fit your needs. Our team of experts will turn your vision into functional and inspiring learning spaces. Use our Harmony Line furniture pieces to create integrated kindergarten classrooms with these ideas.

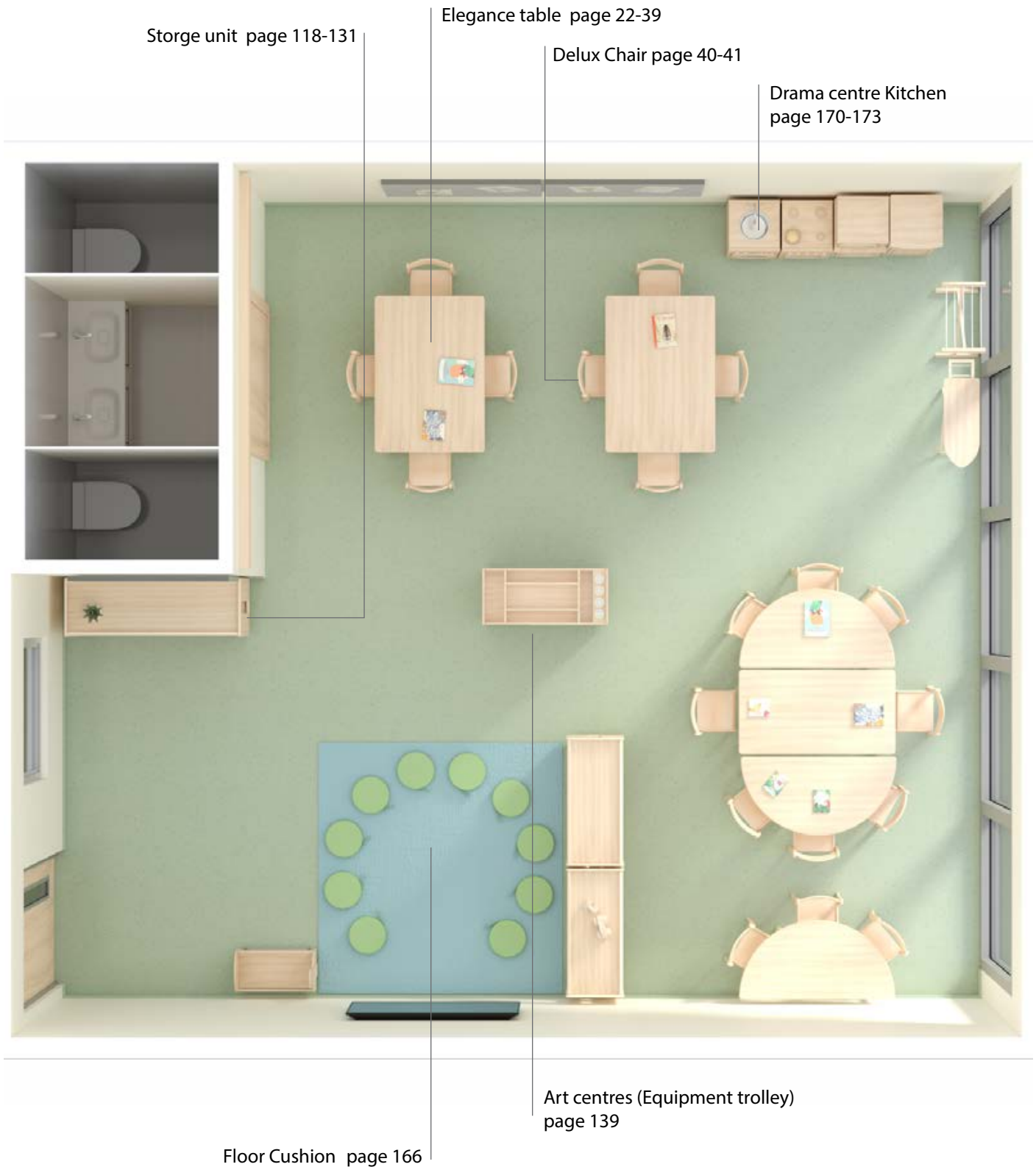



## Prime Line

### The Metal / Wood Series

Grand line is the ideal choice for encouraging creativity and cooperation among children. The construction and materials used ensures that they will remain durable in their everyday use. It gives you the flexibility to create many classroom outfits that satisfy all tastes. It is ergonomically designed for active children in their early years to gently encourage healthy posture. The modular designs offer infinite arrangements, and infinite possibilities. Multi adjustable metal/wooden tables & chairs. Chairs with natural birch plywood seat and back rest. Frames made of rigged metal tubes.

#### Tables:

##### Tops made from:

- 22 mm thick MDF (Medium Density Fibreboard), laminated with HPL (high pressure laminate)
- Tabletops are available in wood grain and beige colour, with high scratch and shock resistant surfaces.
- Newly designed solid wood edges are curved and rounded for safety. No grooves when tables are grouped together or combined.

##### Table legs made from:

- Adjustable metal/ wood table legs, with newly designed construction.
- Legs are fitted with glides to protect floors; floor leveling and reduce noise.
- Legs come separate and can fit to any tabletop size and design. They are easy and quick to assemble and fix using metal threaded insert and screws.
- Table tops legs are adjustable up to 5 heights.
- 5 years guarantee.

#### Chairs:

- Frames made from rigged metal tubes with strong scratch-resistant epoxy paints.
- Seat and backrest made from ergonomically curved multi-layered birch plywood.
- Special leg design provides stability.
- Metal frames are fitted with glides to protect floors and reduce noise.
- Multi stack chairs.
- Comes assembled.
- Very strong and can hold the weight of an adult.
- 5 years guarantee.









## Flexo Tables

These flexible movable creative tables combine contemporary look, functionality, as well as flexibility that encourages social behaviour, creativity and cooperation among students. It comes in a variety of unique shapes and sizes. Each shape and size have its merits and benefits, depending on the learning situation. Tables can be combined with each other or with other tables, combining a multitude of layouts creating an attractive look. Tables are made of Medium-density fibreboard (MDF) covered by high-pressure laminate (HPL). Legs are either fixed or adjustable to offer different heights, an advantage for mixed- age groups.



Easy to clean



As everyone has his/her own choices, we have enabled you to choose your table just as you like! Choose the table- top material and then decide if you want a fixed or adjustable leg. Also you can decide if you want coasters (in two legs) or glides.



=



## 28mm MDF Laminated HPL solid beech edges

Tabletops 28mm thickness are made from extremely strong medium density fibreboard (MDF) insulation, which is stiff, has no knots and has fine edges. The tops are also laminated with high pressure lamination HPL (under heat [80-90 Celsius] and pressure [250 kgs/m<sup>2</sup>]). No added formaldehyde (NAF). Ivory colour or beige wood theme. Edges made from solid beechwood painted with protective varnish, with safe and gently and rounded edges. A special rounded edge design without spacing when tables are grouped (shark nose edges).



A Special rounded Edge design without spacing when tables are grouped (shark nose Edges)

## Wood/Metal legs

These legs can be adjusted according to children different heights. Metal adjustable leg can be used from (C0 - C4) stage. It is ideal for mixed age classrooms.



Available with or without Lockable Casters



Metal insert & Adjustable PP glide



Metal tube welded to bracket angel

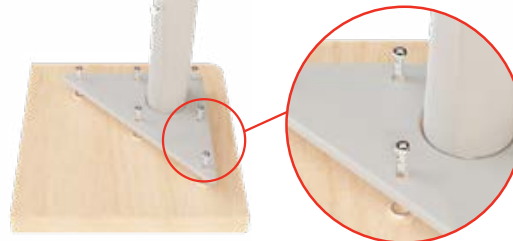

Metal insert & hex heads screws

## Adjustable Leg Heights

**C4** 64 cm

**C3** 59 cm

**C2** 53 cm

**C1** 46 cm

**C0** 40 cm

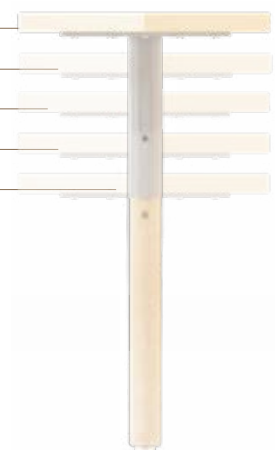

\* Number of legs & Casters are upon table shape

## Rectangular Flexo Table

120 x 60 cm

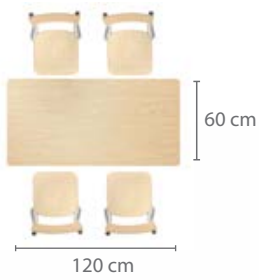

Table combination



● Please Select

Complete table	Table Component	C0	C1	C2	C3	C4
	<p>Table-Top 120 x 60 cm</p>					
<p>Rectangular Table 120 x 60 cm</p>	<p>4 Metal &amp; Wood Legs</p>					
	<p>2 Metal &amp; Wood Legs &amp; 2 Metal &amp; Wood Legs With Casters</p>					

● Please Select  
Legs / Rails Colours



Grey  
43

● Please Select  
Table - Top Colours



Woody  
11



Grey  
13



White  
14

# Rectangular Flexo Table

160 x 80 cm

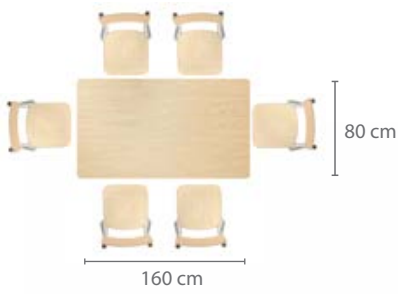



Table combination



● Please Select

Complete table	Table Component	C0	C1	C2	C3	C4
 	 Table -Top 160 x 80 cm					
	 4 Metal & Wood Legs					
Rectangular Table 160 x 80 cm	 2 Metal & Wood Legs & 2 Metal & Wood Legs With Casters					

● Please Select  
Legs / Rails Colours



● Please Select  
Table - Top Colours





## Square Flexo Table 80 x 80 cm

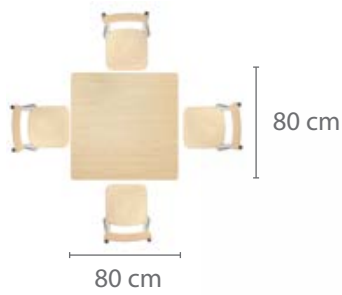
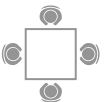





Table combination



● Please Select

Complete table	Table Component	C0	C1	C2	C3	C4
    Square Table 80 x 80 cm	 Table -Top 80 x 80 cm					
	 4 Metal &Wood Legs					
	 2 Metal &Wood Legs & 2 Metal &Wood Legs With Casters					

● Please Select  
Legs / Rails Colours



Grey  
43

● Please Select  
Table - Top Colours



Woody  
11



Grey  
13



White  
14

# U-Shape Flexo Table

180 x 120 cm



Table combination



● Please Select

Complete table	Table Component	C0	C1	C2	C3	C4
	 Table -Top 180 x 120 cm					
	 6 Metal & Wood Legs					
U-Shape Table 180 x 120 cm	 4 Metal & Wood Legs & 2 Metal & Wood Legs With Casters					

● Please Select  
Legs / Rails Colours



Grey  
43

● Please Select  
Table - Top Colours



Woody  
11



Grey  
13







White  
14

## Circular Flexo Table

ø 120 cm

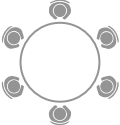

• Please Select

Complete table	Table Component	C0	C1	C2	C3	C4
    Circular Table ø 120 cm	 Table -Top ø 120 cm					
	 4 Metal & Wood Legs					
	 2 Metal & Wood Legs & 2 Metal & Wood Legs With Casters					

• Please Select  
Legs / Rails Colours



Grey  
43

• Please Select  
Table - Top Colours



Woody  
11



Grey  
13



White  
14





## Simple Chair

Sturdy, durable, and light chairs, constructed with superior-formed metal pipes. Seat and backrest are made from environmental-friendly plywood for comfortable seating. These chairs are stackable or can be placed on tabletops, allowing for easy classroom cleaning.



Curved Birch plywood seat & backrest



Plastic Cap



Stackable up to 4



Chairs & Tables	Chairs Size	Chairs Code	Recommended Tables Height
<b>C0</b>	21 x 22.5 cm - H. 21 cm	<b>48423</b>	40 cm
<b>C1</b>	24 x 25 cm - H. 26 cm	<b>48424</b>	46 cm
<b>C2</b>	28 x 28 cm - H. 31 cm	<b>43505</b>	53 cm
<b>C3</b>	32 x 32 cm - H. 35 cm	<b>43506</b>	59 cm
<b>C4</b>	34 x 34 cm - H. 38 cm	<b>48425</b>	64 cm



### Chairs - Metal Frame Colours



● Gray  
01-43



## New Simple Chair

A little twist made in the design to bring this simple yet catchy chair to you. Constructed with superior-formed metal pipes. Seat and back made from environmental-friendly plywood for comfortable seating. These chairs are stackable or can be placed on tabletops, allowing for easy classroom cleaning.



Curved Birch plywood seat & backrest



Plastic Cap



Stackable up to 4



Chairs & Tables	Seats Size	Chairs Code	Recommended Tables Height
<b>C0</b>	21 x 22.5 cm - H. 21 cm	<b>48475</b>	40 cm
<b>C1</b>	24 x 25 cm - H. 26 cm	<b>48476</b>	46 cm
<b>C2</b>	28 x 28 cm - H. 31 cm	<b>48477</b>	53 cm
<b>C3</b>	32 x 32 cm - H. 35 cm	<b>48478</b>	59 cm
<b>C4</b>	34 x 34 cm - H. 38 cm	<b>48479</b>	64 cm



### Chairs - Metal Frame Colours



● Gray  
01-43





## Classroom **Fit-Outs**

We offer custom-designed room plans to fit your needs. Our team of experts will turn your vision into functional and inspiring learning spaces. Use our Harmony Line furniture pieces to create integrated kindergarten classrooms with these ideas.

Storage unit page 118-131

Simple / New simple Chair  
page 56-59



Floor Cushion 160-161

Art centres (Equipment trolley)  
page 139



# Stool & Benches

Our versatile collection of stools and benches provide ample space in any learning environment. Comfortable yet practical, they are suitable for various needs and gentle on the floor with plastic glides. Their strong construction ensures stability and support.











# Stool & Benches

## Stool Table

A new product to complement our stools. Made with solid beechwood legs using finger jointed traditional carpentry and a high-quality adhesive. The top is made of multilayer plywood laminated HPL for easy cleaning and durability.



● Please Select

Complete table	Table Component	C0	C1	C2	C3	C4
 <p>Stool Table ø 60 cm</p>	 <p>Table -Top with wooden frame ø 60 cm</p>  <p>4 Wooden legs</p>	43010	43011	43012	43013	43014

● Please Select  
Legs / Rails Colours



Natural plywood  
01

● Please Select  
Table - Top Colours



Woody  
11

## Stool

A high-quality stool made of solid beechwood frame and plywood seat. The legs have double dowel connections for maximum stability. The curved design eliminates corners where little ones can get caught. Easy to assemble for storage, with neutral tones that match many of our tables. Plastic glides prevent marks or divots on the floor, even after years of use.



**C0** ø 22.5 cm  
H. 21 cm  
43020

**C1** ø 25 cm  
H. 26 cm  
43021

**C2** ø 25 cm  
H. 31 cm  
43022

**C3** ø 30 cm  
H. 35 cm  
43023

**C4** ø 30 cm  
H. 38 cm  
43024



# Stool & Benches

## Deluxe Bench

This bench is made of a solid beechwood frame with a laminated plywood seat. It is designed with safety in mind and has no sharp corners. The neutral tone matches many tables and its plastic legs with dowels are gentle on the floor. Its construction provides strength, stability, and support.



C0	75 x 22.5 cm - H. 21 cm	<a href="#">43282</a>
C1	75 x 25 cm - H. 26 cm	<a href="#">43286</a>
C2	75 x 28 cm - H. 31 cm	<a href="#">43287</a>
C3	75 x 32 cm - H. 35 cm	<a href="#">43288</a>
C4	75 x 34 cm - H. 38 cm	<a href="#">43289</a>

## Elegance Bench

This stool and bench are made of solid beechwood with a laminated plywood seat. The neutral tone makes it a good match for many tables. It is gentle on floors, with plastic legs with dowels that glide even after years of use. Its construction ensures strength, stability, and support.



### Elegance Bench

C0	75 x 22.5 cm - H. 21 cm	<a href="#">43030</a>
C1	75 x 25 cm - H. 26 cm	<a href="#">43031</a>
C2	75 x 28 cm - H. 31 cm	<a href="#">43032</a>
C3	75 x 32 cm - H. 35 cm	<a href="#">43033</a>
C4	75 x 34 cm - H. 38 cm	<a href="#">43034</a>







# Toddler

The toddler years are a time of significant cognitive, emotional, and social development. Toddlers aged 0 to 3 years need furniture that supports their physical development. We offer a variety of chairs and tables to meet your needs in this section.



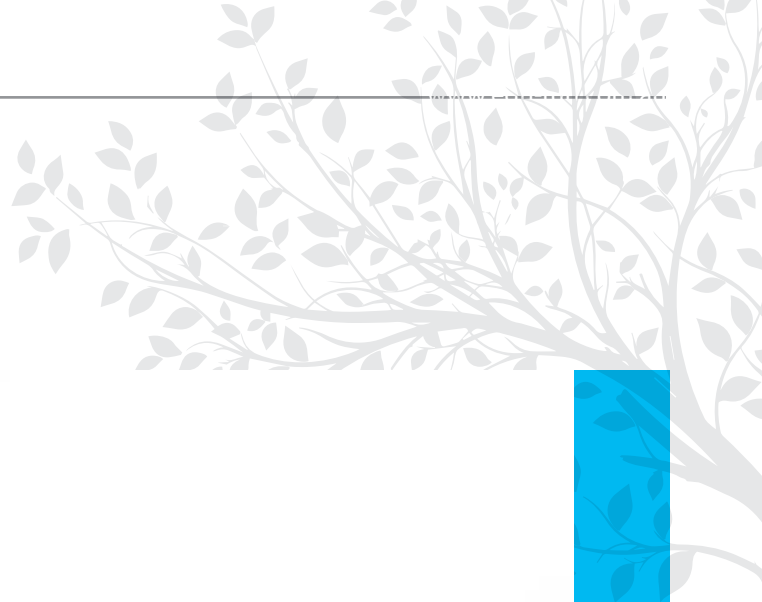

Tables

Chairs

Soft Seating





## Size Chart

We design our furniture collection according to the European standards for “Chairs and Tables for Educational Institutions,” which were approved in January 2007. Children should always use the appropriate size of chairs and tables to maintain good posture and avoid any potential problems or distortions during growth. Adjustable furniture is necessary to accommodate different body heights and provide ergonomic seating.

**BS EN 1729** European standards for chairs and tables

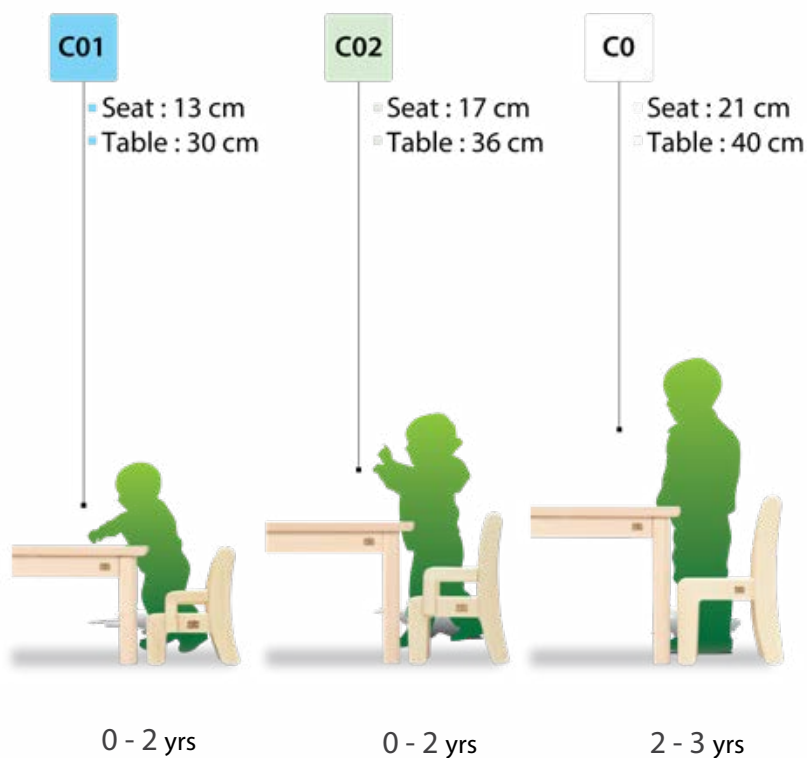



# Toddler

## Elegance Tables



Our Elegance Table line is shipped in a flat-pack for your convenience. Assembly is simple with the included instructions. The finished product is solid, stable, and durable. The tables come in different heights and shapes, and are modular and can be arranged in various configurations. The legs are made from solid wood. Plastic glides or coasters can be added upon request. The table tops are 22mm thick, made from MDF and laminated with HPL. The edges are made from solid beechwood with a protective varnish, smoothed and lightly rounded for safety.

### Rectangular Elegance Table

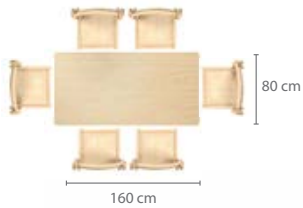
160 x 80 cm



● Please Select





Complete table	Table Component	C01	C02	C0
 Table-Top with wooden frame 160 x 80 cm   Rectangular Table 160 x 80 cm	 Table-Top with wooden frame 160 x 80 cm	69933		
	 Elegance Table legs (4 legs set only)	69968	69969	69970

### Rectangular Elegance Table

120 x 80 cm



● Please Select

Complete table	Table Component	C01	C02	C0
 Table-Top with wooden frame 120 x 80 cm   Rectangular Table 120 x 80 cm	 Table-Top with wooden frame 120 x 80 cm	69919		
	 Elegance Table legs (4 legs set only)	69968	69969	69970

● Please Select  
Legs / Rails Colours

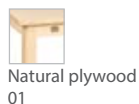

● Please Select  
Table - Top Colours



## Rectangular Elegance Table 120 x 60 cm

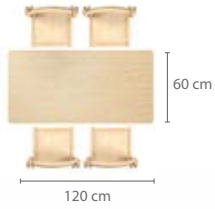

● Please Select

Complete table	Table Component	C01	C02	C0
  Rectangular Table 120 x 60 cm	 Table -Top with wooden frame 120 x 60 cm	69921		
	 Elegance Table legs (4 legs set only)	69968	69969	69970

## Rectangular Elegance Table 80 x 60 cm



● Please Select

Complete table	Table Component	C01	C02	C0
  Rectangular Table 80 x 60 cm	 Table -Top with wooden frame 80 x 60 cm	69920		
	 Elegance Table legs (4 legs set only)	69968	69969	69970

● Please Select  
Legs / Rails Colours



Natural plywood  
01

● Please Select  
Table - Top Colours



Woody  
11



Grey  
13



White  
14

## Square Elegance Table

80 x 80 cm

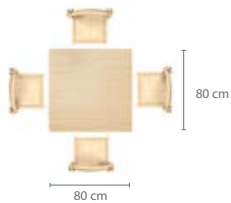

● Please Select

Complete table	Table Component	C01	C02	C0
 Rectangular Table 80 x 80 cm	 Table -Top with wooden frame 80 x 80 cm	69928		
	 Elegance Table legs (4 legs set only)	69968	69969	69970

## Square Elegance Table

60 x 60 cm



● Please Select

Complete table	Table Component	C01	C02	C0
 Rectangular Table 60 x 60 cm	 Table -Top with wooden frame 60 x 60 cm	69929		
	 Elegance Table legs (4 legs set only)	69968	69969	69970

● Please Select  
Legs / Rails Colours

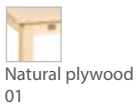

● Please Select  
Table - Top Colours





## Trapezoidal Elegance Table

120 x 52 cm



● Please Select

Complete table	Table Component	C01	C02	C0
  Trapezoidal Table 120 x 52 cm	 Table -Top with wooden frame 120 x 52 cm	69926		
	 Elegance Table legs (4 legs set only)	69968	69969	69970

● Please Select  
Legs / Rails Colours



Natural plywood  
01

● Please Select  
Table - Top Colours



Woody  
11



Grey  
13



White  
14



## U-Shape Elegance Table

180 x 120 cm

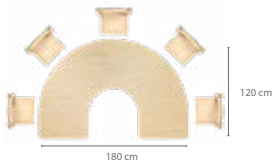

● Please Select





Complete table	Table Component	C01	C02	C0
  U-Shape Table 180 x 120 cm	 Table-Top with wooden frame 180 x 120 cm	69927		
	 Elegance Table legs (6 legs set only)	69807	69808	69800

## U-Shape Elegance Table

150 x 100 cm



● Please Select

Complete table	Table Component	C01	C02	C0
  U-Shape Table 150 x 100 cm	 Table-Top with wooden frame 150 x 100 cm	69931		
	 Elegance Table legs (6 legs set only)	69807	69808	69800

● Please Select  
Legs / Rails Colours

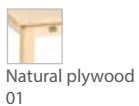

● Please Select  
Table - Top Colours

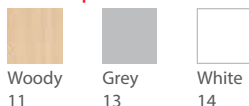



## Circular Elegance Table

ø 120 cm

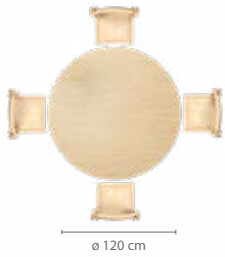

ø 120 cm



● Please Select

Complete table	Table Component	C01	C02	C0
 Table -Top with wooden frame ø 120 cm   Circular Table ø 120 cm	 Table -Top with wooden frame ø 120 cm	69922		
	 Elegance Table legs (4 legs set only)	69968	69969	69970

## Circular Elegance Table





ø 120 cm



ø 120 cm

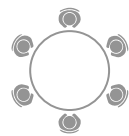

● Please Select

Complete table	Table Component	C01	C02	C0
 Table -Top with wooden frame ø 120 cm   Circular Table ø 120 cm	 Table -Top with wooden frame ø 120 cm	69930		
	 Elegance Table legs (4 legs set only)	69807	69808	69800

● Please Select  
Legs / Rails Colours

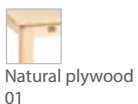

● Please Select  
Table - Top Colours





## Circular Elegance Table

ø 90 cm



● Please Select

Complete table	Table Component	C01	C02	C0
  Table-Top with wooden frame ø 90 cm	 Elegance Table legs (4 legs set only)	69923		
Circular Table ø 90 cm		69968	69969	69970

## Smi-Circular Elegance Table

120 x 60 cm



● Please Select

Complete table	Table Component	C01	C02	C0
  Table-Top with wooden frame 120 x 60 cm	 Elegance Table legs (4 legs set only)	69924		
Circular Table 120 x 60 cm		69968	69969	69970

● Please Select  
Legs / Rails Colours



Natural plywood  
01

● Please Select  
Table - Top Colours



Woody  
11



Grey  
13



White  
14



# Toddler

## Kinder Tables

Robust solid tables designed to last for generations. Kinder Tables are packed flat for your convenience and can be easily assembled with the included instructions. The tables come in 3 convenient heights and 4 functional shapes, with legs made of solid wood. Ideal for young children from 1 to 3 years old.

- Tabletop 28mm made from extremely strong MDF (medium density fiberboard) laminated with HPL (high pressure laminate). Edges are made from solid beechwood with a protective varnish and are smoothly rounded to avoid any injury risks.

### Circular Kinder Table

ø 60 cm



• Please Select

Complete table	Table Component	C01	C02	C0
  Table-Top with wooden frame ø 60 cm		69952		
Circular Table ø 60 cm	 Elegance Table legs (4 legs set only)	69990	69991	69992

### Circular Kinder Table

ø 90 cm



• Please Select

Complete table	Table Component	C01	C02	C0
  Table-Top with wooden frame ø 90 cm		69953		
Circular Table ø 90 cm	 Elegance Table legs (4 legs set only)	69990	69991	69992

• Please Select  
Legs / Rails Colours



Beige  
42

• Please Select  
Table - Top Colours



Woody  
11



Grey  
13



White  
14

## Rectangular Kinder Table

80 x 60 cm



● Please Select





Complete table	Table Component	C01	C02	C0
  Rectangular Table 80 x 60 cm	 Table -Top with wooden frame 80 x 60 cm	69950		
	 Elegance Table legs (4 legs set only)	69990	69991	69992

## Square Kinder Table

60 x 60 cm



● Please Select

Complete table	Table Component	C01	C02	C0
  Square Kinder Table 60 x 60 cm	 Table -Top with wooden frame 60 x 60 cm	69951		
	 Elegance Table legs (4 legs set only)	69990	69991	69992

● Please Select  
Legs / Rails Colours



● Please Select  
Table - Top Colours





## Elegance Toddler Chair

This beautifully crafted armed chair would be a great addition to any nursery or daycare center. It is specially made in smaller sizes to provide comfort and support to little ones. The chair is constructed from solid, top-quality lacquered beechwood and is built to last.

Availabile Colours \_\_\_\_\_

● Natural plywood  
01-01



Arm

- C01 43211 19 x 20 cm - H. 13 cm
- C02 43212 21 x 22.5 cm - H. 17 cm
- C0 43206 21 x 22.5 cm - H. 21 cm

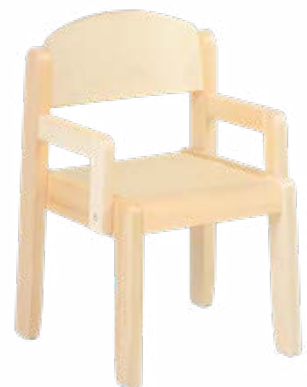

## Deluxe Toddler Chair

This natural armed chair is designed to last for generations. The ergonomically curved seat and backrest provide the most comfortable seating for young children. The chair is specially made for toddlers. It is constructed from solid, top-quality lacquered beechwood and plywood.

Availabile Colours \_\_\_\_\_

● Natural plywood  
01-01



Arm

- C01 43217 19 x 20 cm - H. 13 cm
- C02 43218 21 x 22.5 cm - H. 17 cm
- C0 43305 21 x 22.5 cm - H. 21 cm





## Captain Toddler Chair

This classic-style seating is made from high-quality solid beechwood. It features a recessed wooden seat base and a wrap-around seat back that provides back and side support for children. It is suitable for growing toddlers who are becoming more independent while still providing security. The chair is robustly constructed for heavy usage and has a durable natural polished varnish finish.



Metal bracket & solid massive beech leg



**C01** 45 x 40 cm - H. 13 cm  
43513



**C02** 45 x 40 cm - H. 17 cm  
43514



**C0** 45 x 40 cm - H. 21 cm  
43515



## Reversible cube chair

A chair that can grow with your toddler, just flip it to change the height. It can be repositioned by little ones as a result to its lightweight. It can be used as a small table. Benches are also available. Chair sides are made from kiln dry beach wood. Seat and back rest are made from plywood.



Chair	43342	31x 31.2 cm - H.32.8 cm
Bench	43347	63 x31.2 cm - H.32.8 cm

### Chair



seat h 17  
Chair 31 x 31.2 x 32.8 cm



seat h 13



Table 32.8 x 32.8 x 31.2 cm

### Bench



seat h 21  
Bench 63 x31.2 x 32.8 cm



seat h 13

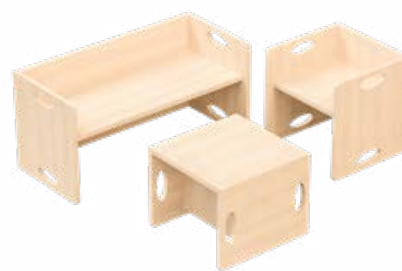

Table 63 x 32.8 x 31.2 cm



## Flip around Chair

This infant to toddler-sized chair is perfect for small children. The chair is light and children can reposition it themselves. The seat height is different when you turn it over, or can be used as a small independent desk. Oval holes on its sides facilitate handling. Chairs are made from laminated plywood. Benches are also available.



Chair	43340	30 x 32 cm - H.31 cm
Bench	43345	67 x 30 cm - H.31 cm

### Chair



seat h 21  
Chair 30 x 26 x 32 cm



seat h 13  
Chair 30 x 26 x 32 cm



Table 30 x 32 x 26 cm

### Bench



seat h 21  
Bench 67 x 26 x 32 cm



seat h 13  
Bench 67 x 26 x 32 cm



Table 67 x 32 x 26 cm



## Chairs & Benches

These wooden chairs and benches are the perfect choice for toddlers and can be used in child-care centers, nurseries, or children's rooms at home. They encourage proper sitting posture in young children. The chairs and benches are designed with safe edges and are made from high-quality beechwood with a lacquered finish. Kinder chairs and benches are available in three sizes.

## Kinder Chair & Benches



- C01 43607 75 x 20 cm - H. 13 cm
- C02 43608 75 x 22.5 cm - H. 17 cm
- C0 43606 75 x 22.5 cm - H. 21 cm



- C01 43602 19 x 20 cm - H. 13 cm
- C02 43603 21 x 22.5 cm - H. 17 cm
- C0 43601 21 x 22.5 cm - H. 21 cm



Stool Stackable up to 4

Sizes from C1 to C4 are available according to request

- C1 43611
- C2 43612
- C3 43613
- C4 43614

## Sit-Me-Up Floor seat

With our soft and sturdy support seat, little ones can practice sitting up and building muscle control. The inviting U-shaped design has a wide, sturdy base and a firm, comfortable surface for resting. The seat is made of easy-to-clean artificial leather and is designed to last.



61 x 46 x 17 cm - 43912





## Flex-Space Lounge

The Flex-Space Lounge is a modular seating solution that is easy to arrange and rearrange to meet your classroom needs. It accommodates up to two students with a padded seat and seat back for extra comfort and support.



Chairs & Tables	Seats Size	Chairs Code
<b>C02</b>	80 x 35 cm - H. 17 cm	<b>43925</b>
<b>C0</b>	80 x 37 cm - H. 21 cm	<b>43926</b>

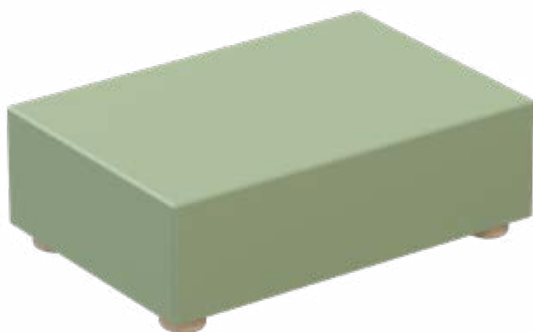

Chairs & Tables	Seats Size	Chairs Code
<b>C02</b>	80 x 35 cm - H. 17 cm	<b>43940</b>
<b>C0</b>	80 x 37 cm - H. 21 cm	<b>43941</b>

Available Colours



Beige  
52



Brown  
60



yellow  
59



Orange  
57



Red  
58



Gray  
53



Light Blue  
54



Blue  
35



Light Green  
61



Green  
56



Chairs & Tables	Seats Size	Chairs Code
<b>C02</b>	80 x 35 cm - H. 17 cm	<b>43950</b>
<b>C0</b>	80 x 37 cm - H. 21 cm	<b>43951</b>



Chairs & Tables	Seats Size	Chairs Code
<b>C02</b>	80 x 35 cm - H. 17 cm	<b>43960</b>
<b>C0</b>	80 x 37 cm - H. 21 cm	<b>43961</b>

Available Colours:









# Teacher Furniture

An excellent choice for teachers and child care providers Here we offer furniture which is designed to keep adults comfortable while they interact with the class at their level. With an adult-sized seat and backrest, chairs offer the appropriate room and support for adults to sit comfortably. Also stools - with special heights- are available.

Chairs & Tables	Chairs Height	Tables Height
<b>C5</b>	43 cm	71 cm
<b>C6</b>	46 cm	76 cm

- Also available Low Chair Height 35 cm



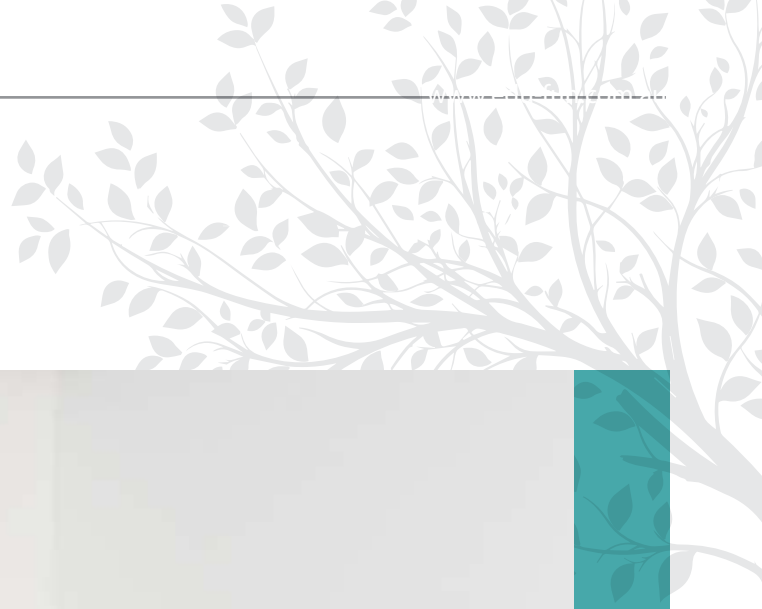

## Elegance Tables





Our Elegance Tables for teachers are designed specially for them. It can be shipped in a flat-pack and assembly is simple with the included instructions. Tables are solid, stable, and durable. The legs are made from solid wood. Plastic glides or coasters can be added upon request. The table tops are 22mm thick, made from MDF and laminated with HPL. The edges are made from solid beech wood with a protective varnish, smoothed and lightly rounded.

### Rectangular Elegance Table

120 x 60 cm

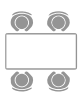

● Please Select



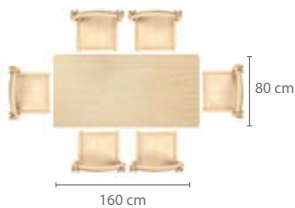

Complete table	Table Component	C5	C6
	 Table -Top with wooden frame 120 x 60 cm	69921	
 Rectangular Table 120 x 60 cm	 Elegance Table legs (4 legs set only)	69975	69976
	 Elegance Table legs (two w/ casters, two w/o casters)	69982	69983

### Rectangular Elegance Table

160 x 80 cm

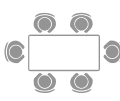

● Please Select

Complete table	Table Component	C5	C6
	 Table -Top with wooden frame 160 x 80 cm	69933	
 Rectangular Table 160 x 80 cm	 Elegance Table legs (4 legs set only)	69975	69976
	 Elegance Table legs (two w/ casters, two w/o casters)	69982	69983

● Please Select  
Legs / Rails Colours

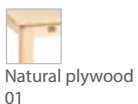

● Please Select  
Table - Top Colours



## Rectangular Elegance Table

120 x 80 cm



● Please Select

Complete table	Table Component	C5	C6
    Rectangular Table 120 x 80 cm	 Table -Top with wooden frame 120 x 80 cm	69919	
	 Elegance Table legs (4 legs set only)	69975	69976
	 Elegance Table legs (two w/ casters, two w/o casters)	69982	69983

## Rectangular Elegance Table

80 x 60 cm

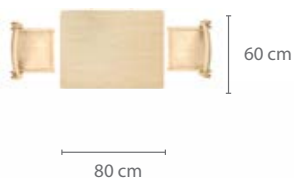

● Please Select

Complete table	Table Component	C5	C6
    Rectangular Table 80 x 60 cm	 Table -Top with wooden frame 80 x 60 cm	69920	
	 Elegance Table legs (4 legs set only)	69975	69976
	 Elegance Table legs (two w/ casters, two w/o casters)	69982	69983

● Please Select  
Legs / Rails Colours



Natural plywood  
01

● Please Select  
Table - Top Colours



Woody  
11



Grey  
13



White  
14



## Circular Elegance Table

ø 120 cm



● Please Select

Complete table	Table Component	C5	C6
	 Table -Top with wooden frame ø 120 cm	69922	
	 Elegance Table legs (4 legs set only)	69975	69976
Rectangular Table ø 120 cm	 Elegance Table legs (two w/ casters, two w/o casters)	69982	69983

## Circular Elegance Table

ø 120 cm



● Please Select

Complete table	Table Component	C5	C6
	 Table -Top with wooden frame ø 120 cm	69930	
	 Elegance Table legs (4 legs set only)	69805	69806
Rectangular Table ø 120 cm	 Elegance Table legs (two w/ casters, two w/o casters)	69815	69816

● Please Select  
Legs / Rails Colours

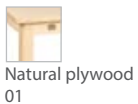

● Please Select  
Table - Top Colours



## Square Elegance Table

80 x 80 cm

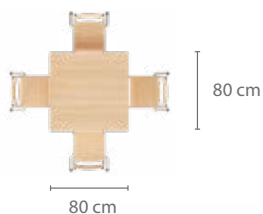

● Please Select

Complete table	Table Component	C5	C6
	<p>Table-Top with wooden frame 80 x 80 cm</p>	69928	
<p>Rectangular Table 80 x 80 cm</p>	<p>Elegance Table legs (4 legs set only)</p>	69975	69976
	<p>Elegance Table legs (two w/ casters, two w/o casters)</p>	69982	69983

● Please Select  
Legs / Rails Colours



Natural plywood  
01

● Please Select  
Table - Top Colours



Woody  
11



Grey  
13



White  
14

# Teacher Furniture

## Deluxe Teacher Chair

The Deluxe chair's wooden frame is made of kiln-dried beech wood and is varnished. The backrest and seat are constructed from multilayer birch plywood. With an adult-sized seat and backrest, this chair offers the appropriate room and support for adults to sit comfortably. The legs are equipped with plastic glides to protect floors, reduce noise, and prevent water and humidity from penetrating the wood.

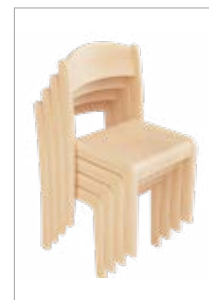

Stackable up to 4



Chairs & Tables	Seats Size	Chairs Code
<b>C5</b>	38 x 40 cm - H. 43 cm	<b>43310</b>
<b>C6</b>	40 x 42 cm - H. 46 cm	<b>43311</b>

### Available Seats & backs Colours

- Natural plywood  
01-01

## Deluxe Teacher - **Low** Chair

Ergonomically designed chairs built to last for generations. Each chair is constructed from solid, top-quality lacquered beech wood and plywood. Featuring a curved seat and backrest for added comfort. The 35 cm seat height is designed to allow teachers to interact with children at an ideal level whether that is for reading, drawing, feeding or other activities. Adult seat width for maximum comfort.



40 x 42 cm - H. 35 cm

**43281**



## Simple Teacher Chair

The simple chair frame is constructed with durable metal pipes. With an adult-sized seat and backrest, this chair offers the appropriate room and support for adults to sit comfortably. The seat and backrest are made from multi-layer plywood. The chairs can be stacked up to four for space-saving purposes. The angled legs provide stability and prevent tipping. The legs are fitted with plastic glides to protect floors and reduce noise.



Stackable up to 4



Chairs & Tables	Seats Size	Chairs Code
<b>C5</b>	40 x 42 cm - H. 43 cm	<b>43314</b>
<b>C6</b>	40 x 42 cm - H. 46 cm	<b>43315</b>

Available frame Colours \_\_\_\_\_

● Gray  
01-43

## Simple Teacher - **Low** Chair

Sturdy, durable, and lightweight chairs. Constructed with superior formed metal pipes and an environmentally-friendly plywood seat and back for comfortable seating. Chairs are stackable and sit securely on tabletops, making it easy to clean the room. The 35 cm seat height is designed to allow teachers to interact with children at an ideal level whether that is for reading, drawing, feeding or other activities. Adult seat width for maximum comfort.



40 x 42 cm - H. 35 cm

**48428**







# Teacher Furniture

## New **Simple** Teacher Chair

A little twist made in the design to bring this simple yet catchy chair to you. Constructed with superior-formed metal pipes. With an adult-sized seat and backrest, this chair offers the appropriate room and support for adults to sit comfortably. Seat and back made from environmental-friendly plywood for comfortable seating. These chairs are stackable or can be placed on tabletops, allowing for easy classroom cleaning.



Stackable up to 4



Chairs & Tables	Seats Size	Chairs Code
<b>C5</b>	40 x 42 cm - H. 43 cm	<b>43318</b>
<b>C6</b>	40 x 42 cm - H. 46 cm	<b>43319</b>

Available frame Colours \_\_\_\_\_

● Gray  
01-43

## New **Simple** Teacher - **Low** Chair

Sturdy, durable, and lightweight chairs. Constructed with superior formed metal pipes and an environmentally-friendly plywood seat and back for comfortable seating. Chairs are stackable and sit securely on tabletops, making it easy to clean the room. The 35 cm seat height is designed to allow teachers to interact with children at an ideal level whether that is for reading, drawing, feeding or other activities. Adult seat width for maximum comfort.



40 x 42 cm - H. 35 cm

**48429**

## Stool Chair - Teacher

A high-quality stool made of solid beechwood frame and plywood seat. The legs have double dowel connections for maximum stability, with a curved design that eliminates corners where little ones can get caught. Easy to assemble for storage, with neutral tones that match many of our tables. Plastic glides prevent marks or divots on the floor, even after years of use.



Chairs & Tables	Seats Size	Chairs Code
<b>C5</b>	ø 35 cm - H. 43 cm	<b>43025</b>
<b>C6</b>	ø 35 cm - H. 46 cm	<b>43026</b>

### Avalibale Seats Colours

- Natural plywood  
01-01

## Stool Low Chair - Teacher

Sturdy, durable, and lightweight chairs. Constructed with superior formed metal pipes and an environmentally-friendly plywood seat and back for comfortable seating. Chairs are stackable and sit securely on tabletops, making it easy to clean the classroom.



ø 30 cm - H. 35 cm

**43027**







# Teacher Furniture

## Curves - Soft Seating

Our line of Soft seating, Curves, brings reading corners, open spaces, and reception areas to life. Six shapes fit together like puzzle pieces to create 3D masterpieces, and can be arranged into different formations for a modern look in your interior.



		
Curves Soft Seating Circle (Ottomans)	Curves Soft Seating Semi Circle (Ottomans)	Curves Soft Seating Bites (Ottomans)
C5 H. 43 cm - ø 45 cm - <b>43570</b>	C5 H. 43 cm - ø 45 cm - <b>43573</b>	C5 H. 43 cm - ø 45 cm - <b>43571</b>
C6 H. 46 cm - ø 45 cm - <b>43580</b>	C6 H. 46 cm - ø 45 cm - <b>43583</b>	C6 H. 46 cm - ø 45 cm - <b>43581</b>
		
Curves Soft Seating Infinity (Ottomans)	Curves Soft Seating Corner (Ottomans)	Curves Soft Seating Big Circle (Ottomans)
C5 H. 43 cm - 90 x 45 cm - <b>43572</b>	C5 H. 43 cm - 95 x 57cm - <b>43579</b>	C5 H. 43 cm - ø 60 cm - <b>43575</b>
C6 H. 46 cm - 90 x 45 cm - <b>43582</b>	C6 H. 46 cm - 95 x 60 cm - <b>43589</b>	C6 H. 46 cm - ø 60 cm - <b>43585</b>

Available Colours:



## Flex-Space Lounge

The Flex-Space Lounge is a modular seating solution that is easy to arrange and rearrange to meet your needs. It accommodates up to two teachers with or without a padded seat and seat back for extra comfort.



Chairs & Tables	Seats Size	Chairs Code
<b>C5</b>	120 x 57 cm - H. 43 cm	<b>43576</b>
<b>C6</b>	120 x 60 cm - H. 46 cm	<b>43586</b>

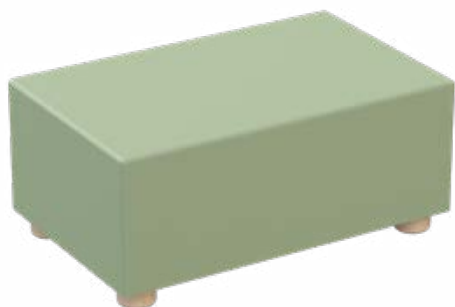

Chairs & Tables	Seats Size	Chairs Code
<b>C5</b>	120 x 57 cm - H. 43 cm	<b>43577</b>
<b>C6</b>	120 x 60 cm - H. 46 cm	<b>43587</b>



Chairs & Tables	Seats Size	Chairs Code
<b>C5</b>	95 x 62 cm - H. 43 cm	<b>43578</b>
<b>C6</b>	95 x 65 cm - H. 46 cm	<b>43588</b>







# Storage Units

Our versatile storage systems keep preschool educational spaces functional and tidy. With modern styling, our storage is available in natural or colorful themes to match the creative educational environment and can be configured to meet your layout requirements. Our range has been designed to separate spaces for different activities and to match with our table and chair systems. Available in various sizes and colors.









# Storage Units

## Ultimate N Storage Units

The Ultimate Unit is made from 18mm-thick strong Medium-Density Fiberboard (MDF). It is laminated with High-Pressure Lamination (HPL) on both sides for added durability and protection. The edges and rails are made of solid beech wood with a rounded profile for improved aesthetic appeal. All edges and corners are rounded in accordance with international safety standards and coated with a protective varnish to ensure its longevity. It has four castors, two of which are lockable and two are non-lockable.



Curvy edges for more safety.



Solid beech Profile.



Heavy-duty lockable castors



See Through storage units



Wall storage units



# Storage Units

## Ultimate N Storage Units wide range of width & height

Wall storage units



See Through storage units



Wall storage units

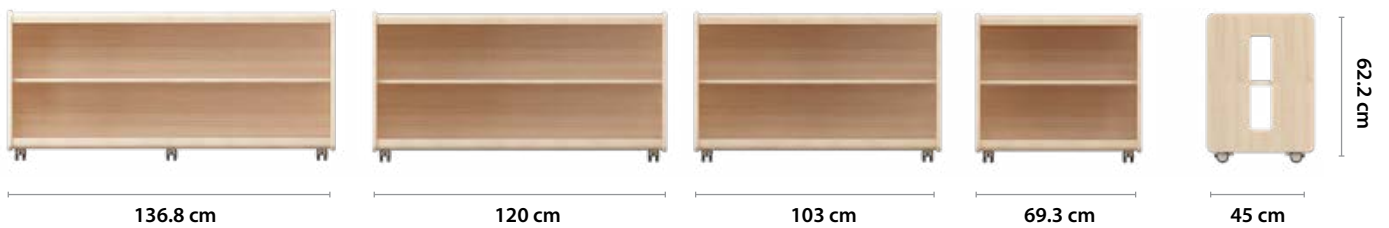

See Through storage units



Wall storage units





## Ultimate N Curved Storage Units

Quarter storage units

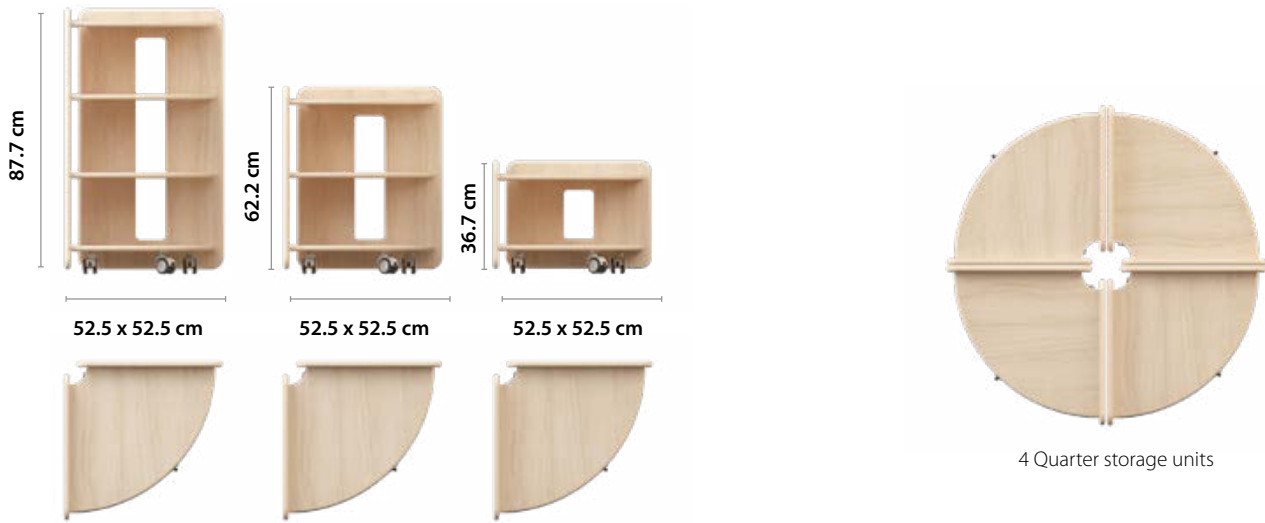

Quarter storage units

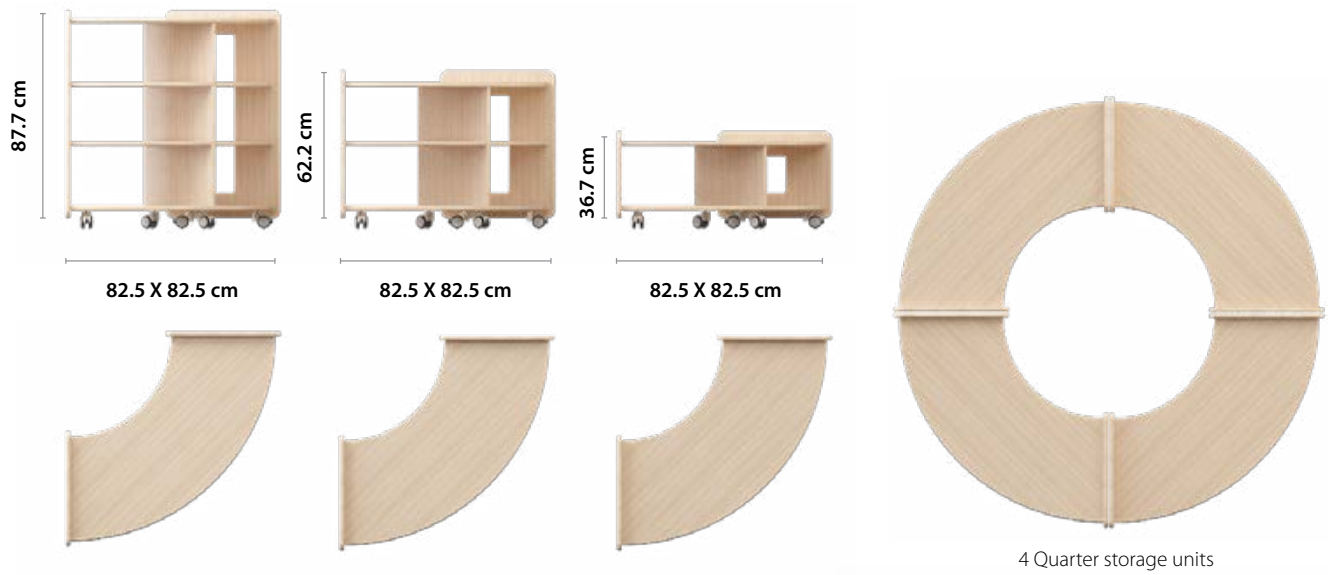

Semi Quarter storage units





# Storage Units

## Classroom **Fit-Outs**

We offer custom-designed room plans tailored to your needs. Our team of experts can turn your vision into functional and inspirational learning spaces. Use our Ultimate N Storage units to create integrated Kindergarten classrooms.





## Ultimate N Storage Units Combination

Curved Ultimate N Storage Units  
Size : 82.5 x 82.5 x 62.2 cm

Curved Ultimate N Storage Units  
Size : 55.7 x 55.7 x 62.2 cm

Ultimate N  
Storage Units  
Size : 136.8 x 45 x 62.2 cm

Ultimate N  
Storage Units  
Size : 103 x 45 x 62.2 cm

Curved Ultimate N Storage Units  
Size : 52.5 x 52.5 x 62.2 cm

Ultimate N Storage Units  
Size : 120 x 45 x 62.2 cm



## Ultimate N Storage Units

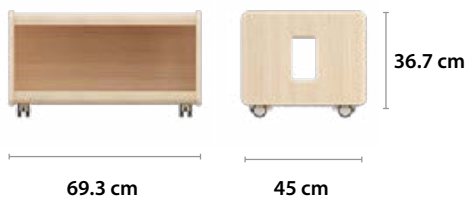

**45481**



**45489**

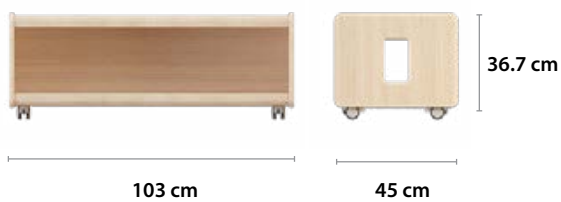

Units Colour



Wood  
01



**45482**

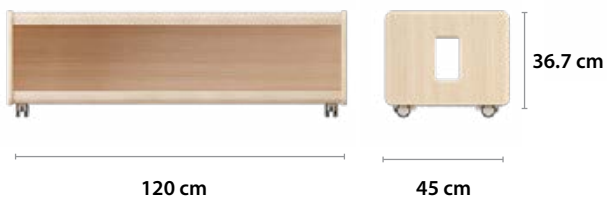

36.7 cm

120 cm

45 cm



**45483**



36.7 cm

136.8 cm

45 cm

Units Colour



Wood  
01



## Ultimate N Storage Units See Through

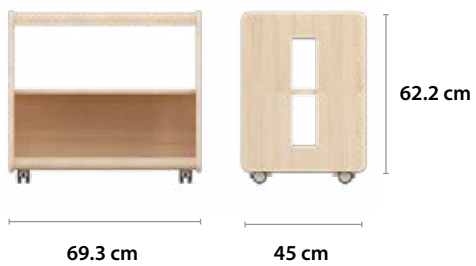

**45490**

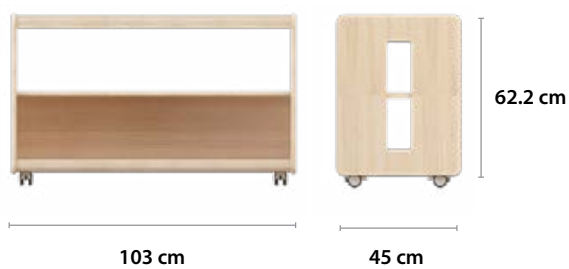

**45494**



## Ultimate N Storage Units



**45491**

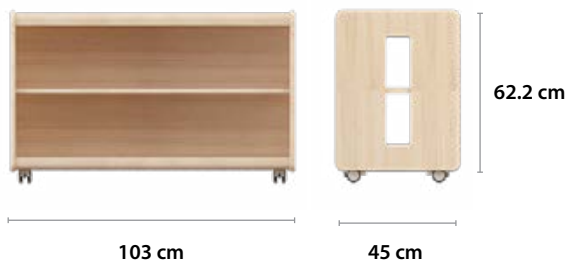

**45495**





## Ultimate N Storage Units See Through





## Ultimate N Storage Units



**45692**



**45493**



120 cm



45 cm

87.7 cm



**45693**



136.8 cm



45 cm

87.7 cm



**45694**



## Ultimate N Storage Units Curved - 1/8 Circle



**45416**



**45417**



**45418**

Units Colour



Wood  
01

## Ultimate N Storage Units Curved-Corner unit



**45426**



**45421**



**45427**

Units Colour



Wood  
01

## Ultimate N Storage Units Curved - 1/4 Circle



**45413**



**45414**



**45415**

Units Colour



Wood  
01





# Reading Centres

Reading centers provide a space for sharing, discussion, solitude, and relaxation. The furniture and ambiance need to reflect this to create a secure learning environment. Our reading center furniture meets all of these requirements and can be configured to your preferred layout design. We offer a functional system that can grow with the needs of your organization.





## Double Sided Display Book Units

This unit is double-sided, which means you can display books on both sides. It is suitable for storing books and magazines and come fully assembled. It has four castors.



Available with Casters

80 x 40 x 100 cm

**45157**





## Curved Storage Box Units

These smooth, well-designed storage units are ideal for reading corners. Their curved exterior and modular design make it possible to create different corners to suit the available space. These units come fully assembled.



91.8 x 36.9 x 81.6 cm

**45150**





## Mobile Book Browser Unit

The Ultimate book display Unit is made from 18mm-thick strong Medium-Density Fiberboard (MDF). It is laminated with High-Pressure Lamination (HPL) on both sides for added durability and protection. and its edges and rails are made of solid beech wood with a rounded profile for improved aesthetic appeal. All edges and corners are rounded in accordance with international safety standards and coated with a protective varnish to ensure its longevity. The High-Pressure Lamination (HPL) on bottom covers the solid beech wood edges, preventing water and humidity from penetrating the MDF core. It has four castors, two of which are lockable and two are non-lockable.



70 x 45 x 62.2 cm **45010**



70 x 45 x 88 cm **45009**



# Reading Centres

## Pyramid Display units

This 2/3 shelves solid beech timber shelving units are so versatile, that not only it can be used as a functional storage unit but also as a room divider with 360-degree access. Shelves are 15 mm Plywood Double wall thickness.



100 x 44 x 81 cm

**45000**



120 x 44 x 108 cm

**45001**





## Art trolley

In our art trolley you can store a lot of paper, paints and brushes. It is an ideal unit for setting up an inspiring space to spark creative little learners. It can be positioned against a wall or can be used to create an island with our other storage units. This solid unit is made from 18mm-thick strong Medium-Density Fiberboard (MDF). It is laminated with High-Pressure Lamination (HPL) on both sides for added durability and protection. It has four castors, two of which are lockable and two are non-lockable.

reduce sag. The unit also features our patented glide-and-tilt tray runner system which allows you to store all your art and craft supplies.



97 x 45 x 88 cm

**45011**



97 x 45 x 78 cm

**45012**



97 x 45 x 60 cm

**45013**



# Room Dividers

Our high-quality, durable, and functional modular room dividers made of beechwood are ideal for dividing large rooms into separate play areas. They are perfect for organizing classroom spaces and creating a variety of spaces for activities such as playing, reading, drawing, etc. Children can also have fun writing on the whiteboard or coloring on the transparent surface. The frame is made of high-quality beechwood.



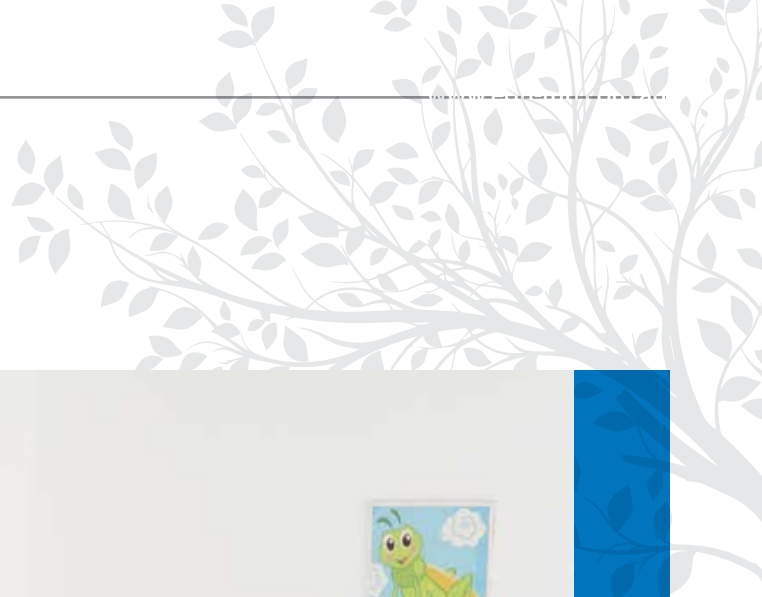

## Room Dividers Units

Classroom spaces should be flexible and can be created with modular panels and shelving units to divide rooms, define spaces, and establish boundaries. The panels can serve more than just as dividers. Transparent panels provide a connection with children while they play. You can add visual motivation or display artwork by attaching mirrors, clear covers, or cork covers to the panels.



Storage Units &  
Dividers Wooden  
Connectors part (A)  
**45867**

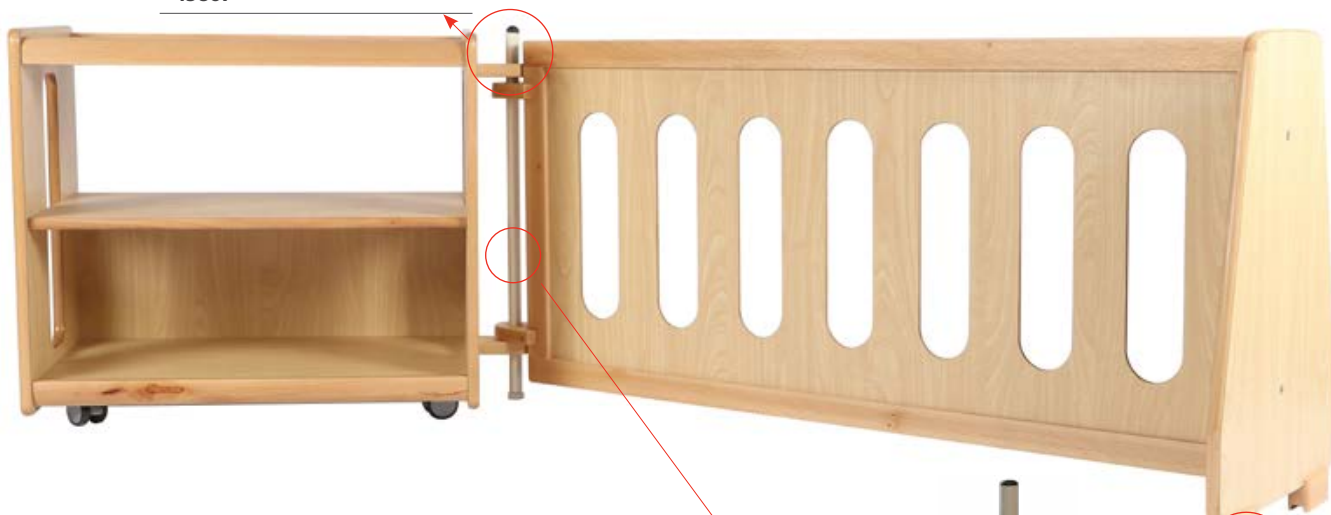

Round Metal Tube Axis

H 30 cm	H 56 Cm	H 84 cm
<b>45892</b>	<b>45893</b>	<b>45894</b>

Dividers  
Wooden foot  
**45869**



Panels options



Sides/Winges

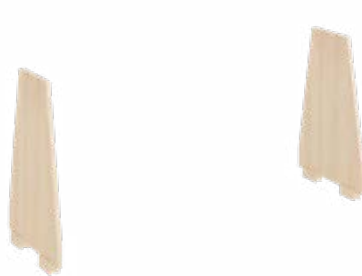

Room dividers units Size & Hight

				82.5 cm
				57 cm
				31.5 cm
87 cm		127 cm		



# Room Dividers

## Dividers Solid Panels

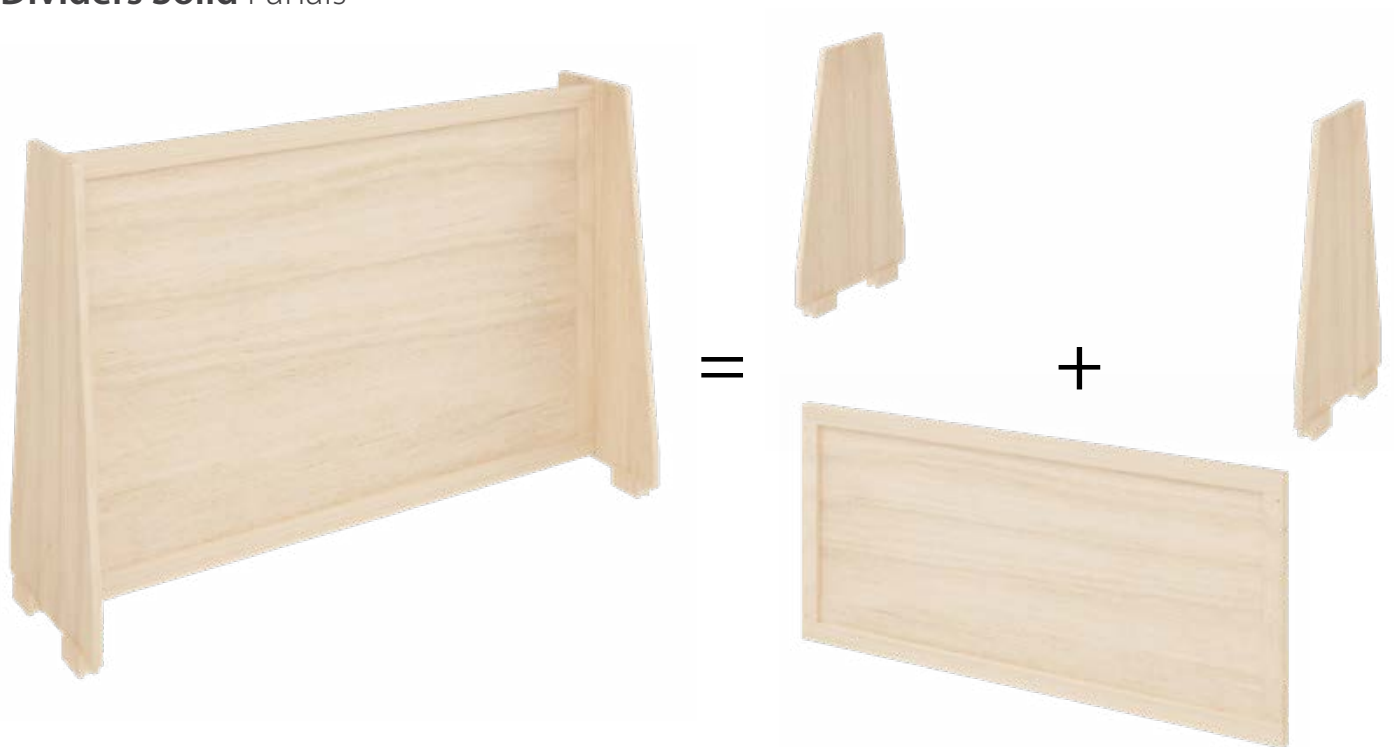

panels W 87 cm*	panels W 127 cm*	Dividers / Wings (set of two)
 W 87 cm x H 31.5 cm   <b>45870</b>	 W 127 cm x H 31.5 cm   <b>45873</b>	 W 40 cm x H 33.7 cm   <b>45895</b>
 W 87 cm x H 57 cm   <b>45871</b>	 W 127 cm x H 57 cm   <b>45874</b>	 W 40 cm x H 59 cm   <b>45896</b>
 W 87 cm x H 82.5 cm   <b>45872</b>	 W 127 cm x H 82.5 cm   <b>45875</b>	 W 40 cm x H 84.7 cm   <b>45897</b>

\* Sides are not included

## Dividers See-Through Panels



panels W 87 cm*		panels W 127 cm*		Dividers / Wings (set of two)	
—		—		—	
W 87 cm x H 57 cm	<b>45876</b>	W 127 cm x H 57 cm	<b>45878</b>	W 40 cm x H 59 cm	<b>45896</b>
W 87 cm x H 82.5 cm	<b>45877</b>	W 127 cm x H 82.5 cm	<b>45879</b>	W 40 cm x H 84.7 cm	<b>45897</b>

\* Sides are not included













# Room Dividers

## Dividers Acrylic/Clear Panels



panels W 87 cm*	panels W 127 cm*	Dividers / Wings (set of two)
		
W 87 cm x H 31.5 cm   <b>45880</b>	W 127 cm x H 31.5 cm   <b>45882</b>	W 40 cm x H 33.7 cm   <b>45895</b>
		
W 87 cm x H 57 cm   <b>45881</b>	W 127 cm x H 57 cm   <b>45883</b>	W 40 cm x H 59 cm   <b>45896</b>
—	—	—

\* Sides are not included

## Dividers Mirror Panels



=



+







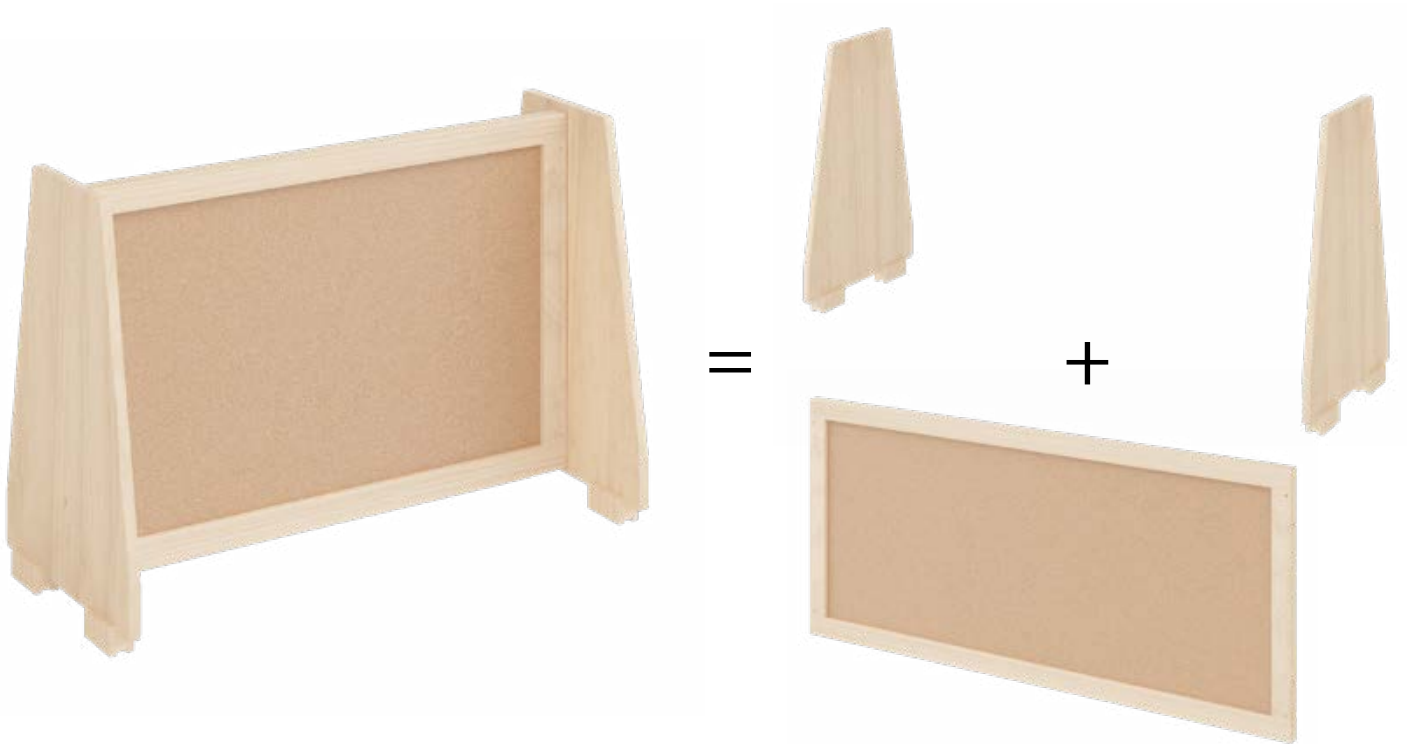

panels W 87 cm*		panels W 127 cm*		Dividers / Wings (set of two)	
					
W 87 cm x H 31.5 cm	<b>45884</b>	W 127 cm x H 31.5 cm	<b>45886</b>	W 40 cm x H 33.7 cm	<b>45895</b>
					
W 87 cm x H 57 cm	<b>45885</b>	W 127 cm x H 57 cm	<b>45887</b>	W 40 cm x H 59 cm	<b>45896</b>
—		—		—	

\* Sides are not included

# Room Dividers

## Dividers Cork Panels



panels W 87 cm*	panels W 127 cm*	Dividers / Wings (set of two)
		
W 87 cm x H 31.5 cm   <b>45888</b>	W 127 cm x H 31.5 cm   <b>45890</b>	W 40 cm x H 33.7 cm   <b>45895</b>
		
W 87 cm x H 57 cm   <b>45889</b>	W 127 cm x H 57 cm   <b>45891</b>	W 40 cm x H 59 cm   <b>45896</b>
—	—	—

\* Sides are not included





# Soft Play

Studies show that active play benefits a child's physical, mental, social, and emotional development. Soft play corners provide a safe and comprehensive way for children to develop. Our collection of soft play pieces offers children a safer place to play and provides endless hours of fun and joy.



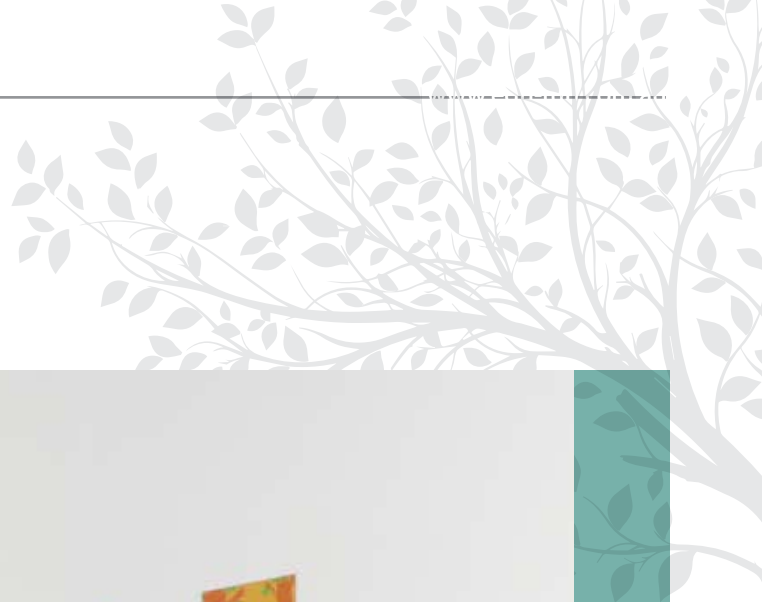

## Multi Activity Soft Play - Small

Young children will have fun with these geometric shapes. The edges of each shape invite another shape to nestle, encouraging interactive play. The warm natural colors promote relaxation and concentration. Made of high-density foam and covered in leather, they are easy to clean with soap and water. Recommended for ages 0 to 3 years.

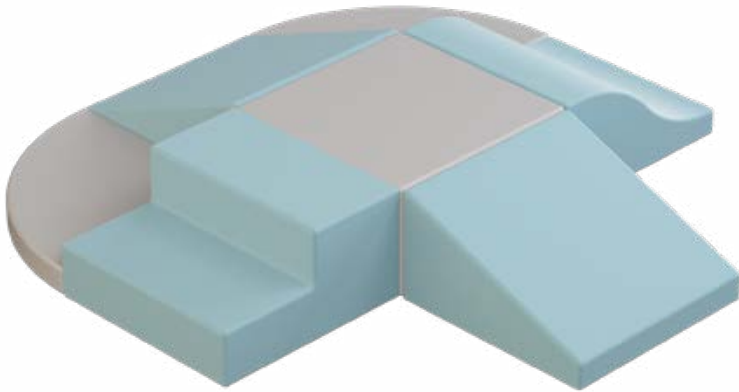

 <p>Soft Play small Quadrant Corner</p>	 <p>Soft Play small Square</p>
<p>50 x 50 x 6.5 cm <b>45995</b></p>	<p>50 x 50 x 25 cm <b>45990</b></p>

 <p>Soft Play small Slide</p>	 <p>Soft Play small Ladder</p>	 <p>Soft Play small Gentle Curve</p>
<p>50 x 50 x 25 cm <b>45993</b></p>	<p>50 x 50 x 25 cm <b>45992</b></p>	<p>50 x 50 x 25 cm <b>45994</b></p>

Available Colours



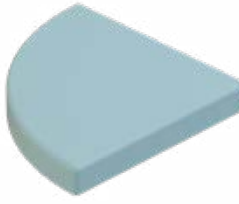
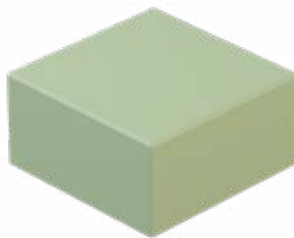

 <p>Soft Play small Quadrant Corner</p>	 <p>Soft Play small Square</p>
<p>40 x 40 x 10 cm <b>45792</b></p>	<p>40 x 40 x 20 cm <b>45793</b></p>

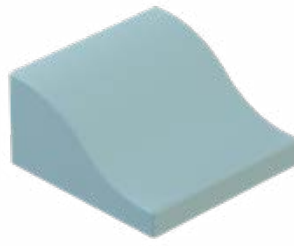
 <p>Soft Play small Slide</p>	 <p>Soft Play small Ladder</p>	 <p>Soft Play small Gentle Curve</p>
<p>40 x 40 x 20 cm <b>45794</b></p>	<p>40 x 40 x 20 cm <b>45795</b></p>	<p>40 x 40 x 20 cm <b>45796</b></p>



Available Colours:







## Multi Activity Soft Play - Large

Children will have fun with these geometric shapes. The edges of each shape invite another shape to nestle, encouraging interactive play. The warm natural colors promote relaxation and concentration. Made of high-density foam and covered in leather, they are easy to clean with soap and water. Recommended for ages 3 to 6 years.

	
Semi-Circular Mat	Soft Play Tunnel
100 x 100 x 12.5 cm <b>45986</b>	50 x 50 x 50 cm <b>45988</b>

		
Soft Play Slide	Soft Play Ladder	Soft Play Gentle Wave
100 x 50 x 50 cm <b>45980</b>	100 x 50 x 50 cm <b>45981</b>	100 x 50 x 50 cm <b>45982</b>

		
Soft Play Two waves	Soft Play Square	Soft Play Quadrant Corner
100 x 50 x 50 cm <b>45983</b>	50 x 50 x 50 cm <b>45984</b>	50 x 50 x 25 cm <b>45985</b>

Available Colours

									
Beige 52	Brown 60	yellow 59	Orange 57	Red 58	Gray 53	Light Blue 54	Blue 35	Light Green 61	Green 56

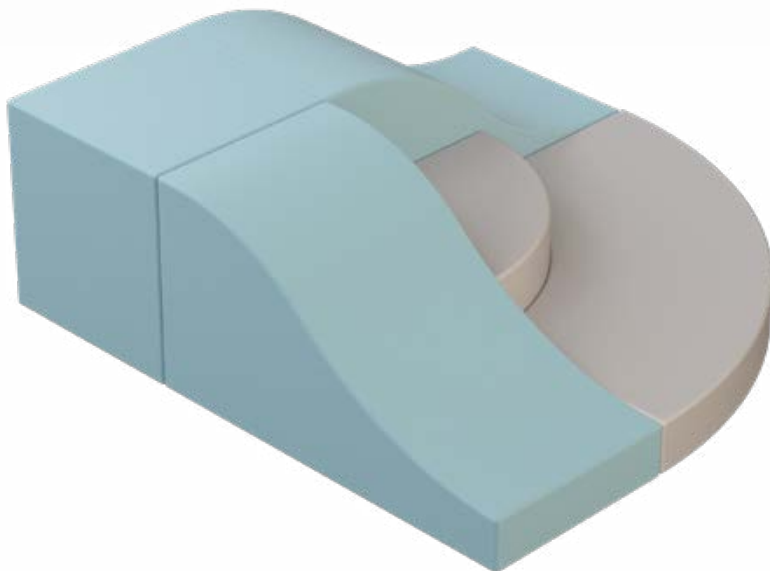
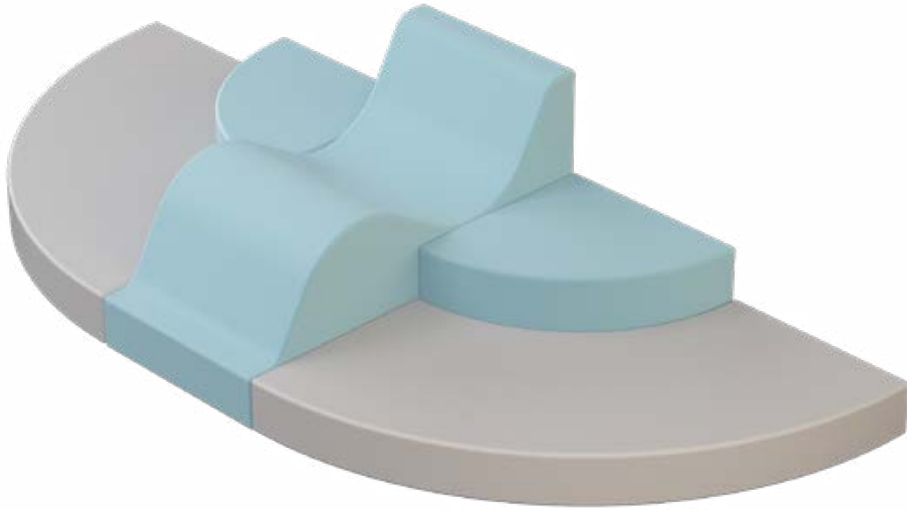



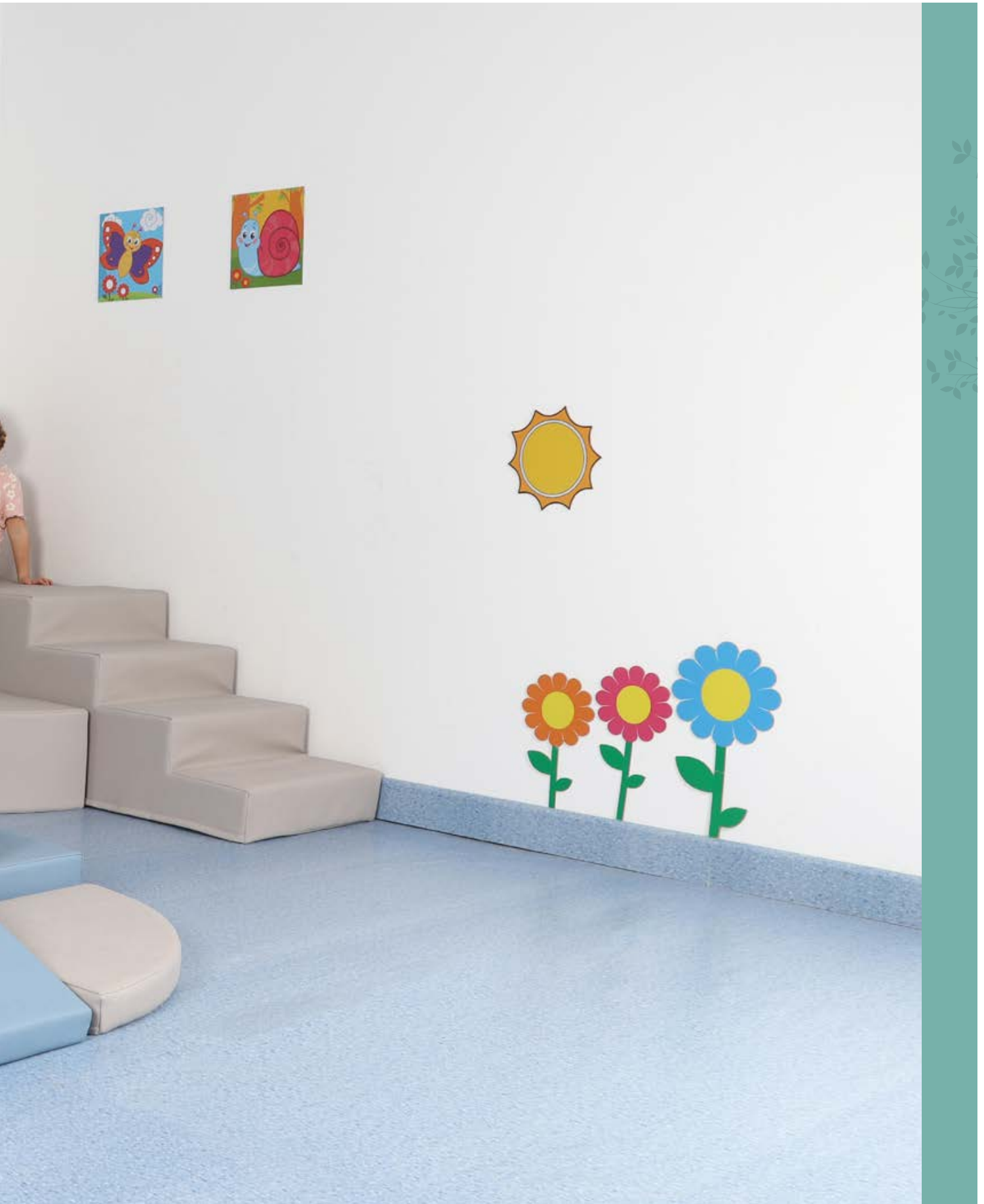



# Soft Seating

Our attractive soft seating collection is ideal for inspirational learning areas. It can be used in many ways in any learning environment. Studies show that children learn better in activity-based spaces. Available in a range of fabric and leather options to suit your needs.





# Soft Seating

## Curves - Soft Seating

Our line of pre-school and school seating, Curves, brings little reading corners, open spaces, and reception areas to life. Different shapes fit together like puzzle pieces to create 3D masterpieces, and can be arranged into different formations for a modern look in your interior.



Curves Soft Seating Circle (Ottomans)

Chairs & Tables	Seats Size	Chairs Code
<b>C2</b>	ø 45 - H. 31 cm	<b>43530</b>
<b>C3</b>	ø 45 - H. 35 cm	<b>43540</b>
<b>C4</b>	ø 45 - H. 38 cm	<b>43560</b>



Curves Soft Seating Semi Circle (Ottomans)

Chairs & Tables	Seats Size	Chairs Code
<b>C2</b>	ø 45 - H. 31 cm	<b>43533</b>
<b>C3</b>	ø 45 - H. 35 cm	<b>43543</b>
<b>C4</b>	ø 45 - H. 38 cm	<b>43563</b>



Curves Soft Seating Bites (Ottomans)

Chairs & Tables	Seats Size	Chairs Code
<b>C2</b>	ø 45 - H. 31 cm	<b>43531</b>
<b>C3</b>	ø 45 - H. 35 cm	<b>43541</b>
<b>C4</b>	ø 45 - H. 38 cm	<b>43561</b>

Available Colours





Curves Soft Seating Infinity (Ottomans )

Chairs & Tables	Seats Size	Chairs Code
<b>C2</b>	90 x 45 cm - H. 31 cm	<b>43532</b>
<b>C3</b>	90 x 45 cm - H. 35 cm	<b>43542</b>
<b>C4</b>	90 x 45 cm - H. 38 cm	<b>43562</b>



Curves Soft Seating Big Circle (Ottomans )

Chairs & Tables	Seats Size	Chairs Code
<b>C2</b>	ø 60 - H. 31 cm	<b>43535</b>
<b>C3</b>	ø 60 - H. 35 cm	<b>43545</b>
<b>C4</b>	ø 60 - H. 38 cm	<b>43565</b>

Available Colours





# Soft Seating

## Flex-Space Lounge

The Flex-Space Lounge is a modular seating solution that is easy to arrange and rearrange to meet your classroom needs. It accommodates up to two students. Available with or without a padded seat and seat back for extra comfort and support.



Chairs & Tables	Seats Size	Chairs Code
<b>C0</b>	80 x 37 cm - H. 21 cm	<b>43926</b>
<b>C1</b>	80 x 42 cm - H. 26 cm	<b>43927</b>
<b>C2</b>	80 x 47 cm - H. 31 cm	<b>43928</b>
<b>C3</b>	80 x 50 cm - H. 35 cm	<b>43929</b>
<b>C4</b>	80 x 50 cm - H. 38 cm	<b>43930</b>

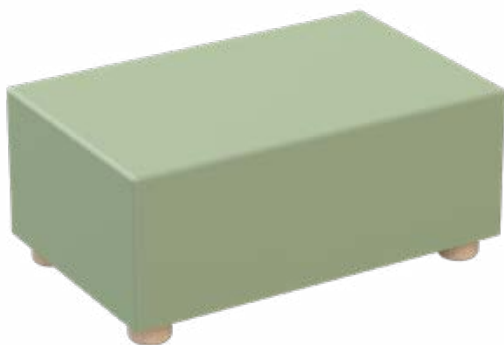

Chairs & Tables	Seats Size	Chairs Code
<b>C0</b>	80 x 37 cm - H. 21 cm	<b>43941</b>
<b>C1</b>	80 x 42 cm - H. 26 cm	<b>43942</b>
<b>C2</b>	80 x 47 cm - H. 31 cm	<b>43943</b>
<b>C3</b>	80 x 50 cm - H. 35 cm	<b>43944</b>
<b>C4</b>	80 x 50 cm - H. 38 cm	<b>43945</b>

Available Colours

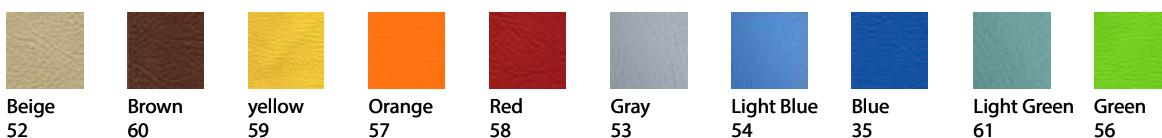

## Flex-Space curved Lounge

The Flex-Space Curved Lounge is a modular seating solution that is easy to arrange and rearrange to meet your classroom needs. It accommodates up to two students. Available with or without a padded seat and seat back for extra comfort and support.



Chairs & Tables	Seats Size	Chairs Code
<b>C0</b>	80 x 37 cm - H. 21 cm	<b>43951</b>
<b>C1</b>	80 x 42 cm - H. 26 cm	<b>43952</b>
<b>C2</b>	80 x 47 cm - H. 31 cm	<b>43953</b>
<b>C3</b>	80 x 50 cm - H. 35 cm	<b>43954</b>
<b>C4</b>	80 x 50 cm - H. 38 cm	<b>43955</b>



Chairs & Tables	Seats Size	Chairs Code
<b>C0</b>	80 x 37 cm - H. 21 cm	<b>43961</b>
<b>C1</b>	80 x 42 cm - H. 26 cm	<b>43962</b>
<b>C2</b>	80 x 47 cm - H. 31 cm	<b>43963</b>
<b>C3</b>	80 x 50 cm - H. 35 cm	<b>43964</b>
<b>C4</b>	80 x 50 cm - H. 38 cm	<b>43965</b>

Available Colours:



# Soft Seating

Our soft cushions are the perfect choice for modern learning. They allow children to sit comfortably and concentrate better. They can be used in reading corners or for sitting and reading their favorite books. They are also compatible with our Elegance and Ultra (C01: C0) tables for various activities and ages.



Circle  
H.7.5 cm - ø 30 cm - [43551](#)  
H.7.5 cm - ø 40 cm - [43550](#)



Available Colours



Beige  
52



Brown  
60



yellow  
59



Orange  
57



Red  
58



Gray  
53



Light Blue  
54



Blue  
35



Light Green  
61



Green  
56



## Cushion Trolley

Cushion Stand made from MDF laminated with melamine on both sides, with edges painted, has four castors, two lockable and two non-lockable. Designed for 12 cushions.



Trolley  
76 x 34 x 65.5 cm - [43556](#)  
76 x 44 x 65.5 cm - [43557](#)



# Drama Centres

Imagination, going shopping, having a tea party for a favorite toy - these are some of the best activities for children. Some children have interpersonal intelligence, meaning they are sensitive to others' moods, feelings, temperaments, and motivations, and have the ability to cooperate in order to work as a part of a group. This section enhances interpersonal intelligence for children who need to break down walls of shyness and helps those who already have it to excel, as they role-play different characters.



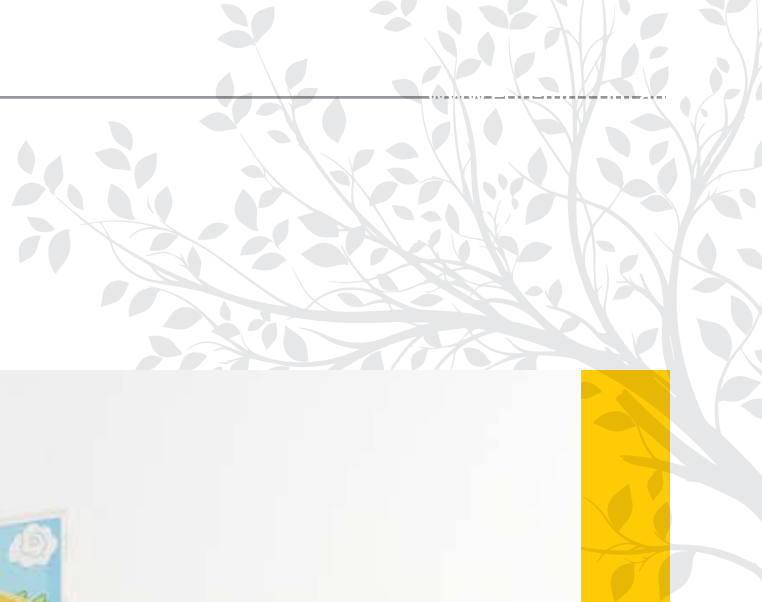

## Children Play **Kitchen**

Our natural-looking kitchen set will make your home corner the most attractive in town! We have combined play value with the highest quality, durability, and value for money in this kitchen set. There are three units in this set (cooker/oven, sink/washing machine, and fridge). All units are constructed from quality lacquered beechwood, which has a tough protective finish, and are designed to withstand even the most boisterous environment.



Children Play Kitchen  
Microwave  
30 x 40 x 40 cm **21804**



Children Play Kitchen  
model unit  
60 x 40 x 40 cm **21803**



Children Play Kitchen Fridge  
85 x 40 x 40 cm **21800**



Children Play Kitchen Cooker  
/ oven  
60 x 40 x 40 cm **21801**



Children Play Kitchen Sink /  
Washing Machine  
60 x 40 x 40 cm **21802**



Children Play Kitchen  
Microwave  
25 x 35 x 30 cm **21704**



Children Play Kitchen  
model unit  
47 x 35 x 35 cm **21703**



Children Play Kitchen Fridge  
85 x 35 x 35 cm **21700**



Children Play Kitchen Cooker  
/ oven  
47 x 35 x 35 cm **21701**



Children Play Kitchen Sink /  
Washing Machine  
47 x 35 x 35 cm **21702**







## Fun Pretend **Clothes Rack**

This beautiful natural-looking child-size clothes rack will keep children entertained for hours with role-playing fun! It can be folded flat for easy storage and is compatible with the Role Play Iron Set.



**21571**  
L 55.3 X W 34 X H 55.3 cm

## Fun Pretend **Iron Set**

This realistic-looking ironing set has been designed to provide hours of imaginative play. It comes with a wooden iron and an ironing board that can be folded flat for storage.



**21566**  
Iron 16.4 x 10.3 x 10 cm  
Iron table 82.5 x 28 x 55 cm





## Children's lounge

This high-quality lounge set is a stylish addition to preschool classrooms or role-playing areas. The frames are made from solid natural wood and the back and seat cushions are covered with either fabric or leather. The lounge encourages social interaction among children during play or while reading books. Its timeless design creates a warm and inviting atmosphere.





**43906**  
Lounge sofa  
Lounge chair  
Lounge table



Lounge chair  
49 x 50 x 60 cm **43908**



Lounge sofa  
89 x 50 x 60 cm **43907**



Lounge table  
60 x 45 x 40 cm **43909**

Available Colours







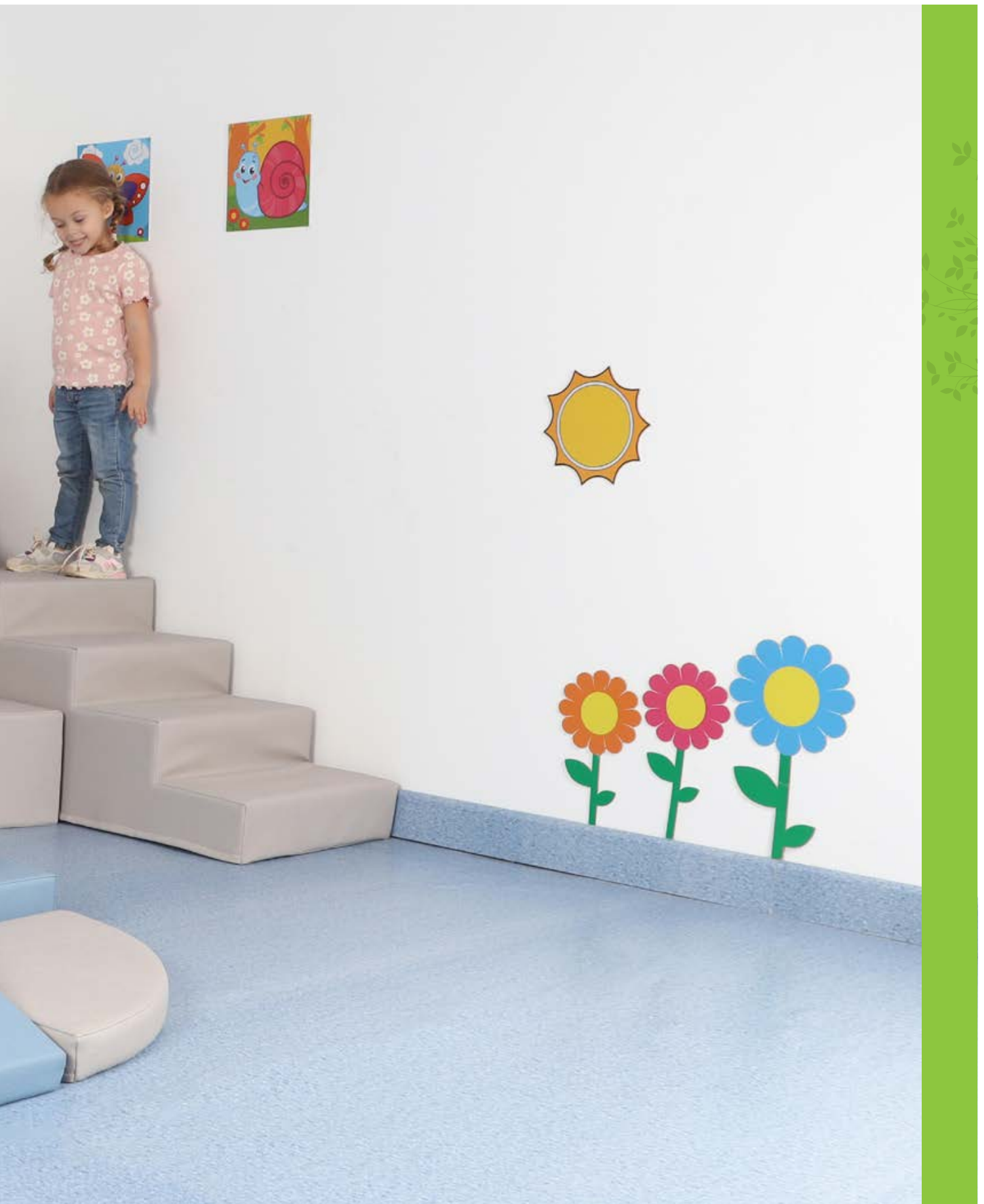





### **Europe & America**

Edu Fun® GmbH  
Rheinstrasse 7 - 77743 Neuried  
Tel.: +49 7807-989315-0  
e-mail: [info@edufun.de](mailto:info@edufun.de)  
web: [www.edufun.de](http://www.edufun.de)

---

### **Australia & Asia**

1 Envision Close , 19 Corporate terrace  
Pakenham, Victoria 3810, Australia  
Tel: + 61 402 266 852  
Email: [sales@edu-fun.com.au](mailto:sales@edu-fun.com.au)  
web: [www.edu-fun.com.au](http://www.edu-fun.com.au)

---

### **Middle East & Africa**

Rukn Al Taleem School Furniture Trading LLC  
Dubai -UAE  
Bader Mohamed Al Maleim Building- Showroom  
No.5  
Behind Al Maliha Street Industrial Area 18 Sharjah  
Tel: +(971) 6767 6216  
Cell: +(971) 56 112 4184  
e-mail: [marketing.uae@edu-fun.com](mailto:marketing.uae@edu-fun.com)  
web: [www.ae.edu-fun.com](http://www.ae.edu-fun.com)