



2017
Educational
Wooden Toys





We are delighted to introduce our 2017 range providing children around the world with toys that stimulate their imagination, increase their knowledge and enhance their mental and physical development.

We believe that a toy should not only be for playing but it is an important tool in the development of a child's self confidence, intelligence and creativity. Our toys are designed by specialists' who understand child development and how toys can stimulate that development at each stage of a child growth.

We use only the best, natural, high quality materials which include European beech wood and German paints and varnishes. All the different stages in making and packaging our high quality products are carried out in our own factories.

EDUFUN has been expanding lately. We have Subsidiaries companies in Australia and KSA beside Dubai and Egypt. Our products are available in more than 25 countries through our Distributes.

Icons



Product Age



Product Code



Product Size



Number of Pieces

Contents



About Edu-Fun	4
Infant & Toddlers	12
Educational Toys	34
Letters & Numbers	72
Dramatic Play	82
Visual Index	88

The leap

Edu-Fun celebrated the opening of its showrooms and offices In September 2016 in **Dubai, UAE**. All international and regional export offices, sales and marketing together with our head offices will be moved to the new location with the beginning of year 2017.

Edu-Fun group is restructuring its activities to keep pace with the growing markets to become a leading regional and an international player.

Dubai as an international business and logistics hub was our perfect choice to move our head quarter, international & regional sales and marketing activities to it. We are sure that with this step we will provide our customers with better and distinguished services.

Our new **Saudi Arabia** show room will open during the early months of 2017 and it is targeting the huge **Saudi Arabia** educational market with the growing demands of public and private schools.

Also **Egypt`s** sales and marketing office serving the African and Mediterranean markets will have a new look starting year 2107. The attached showroom is a unique turning point concept for the schooling market. (Please refer to the last page for information on our head office and branches.)



Production

Since We - **Edu-Fun** - have the first production seed in year 1991 in Egypt, we have expanded our production lines to cope with the expanding demand of our products and provide wide collection of Edu Fun range. New CNC machine centers and painting lines are added for quality and speed development.

We are able to develop new product range by the execution of OEM products with our two factories and four production lines (solid wood, panel board, tube bending, wooden toys and puzzle).



Factory 1991



Lower price... Best quality

Edu-fun keeps expanding its production facilities in **Egypt** in order to balance the fast development and changing of world economy with the devaluation of the Egyptian pound during year 2016. As labor intensive products, Edu fun factories become very competitive with its high labor cost and in the same time one of the cheapest in the world.

Shocking to know is that the price of year 2017 is almost **%50 less**; it is competitive in a challenging way to find that quality with great specification in such low price.

Annual Employee Wages |2010/2011 USD

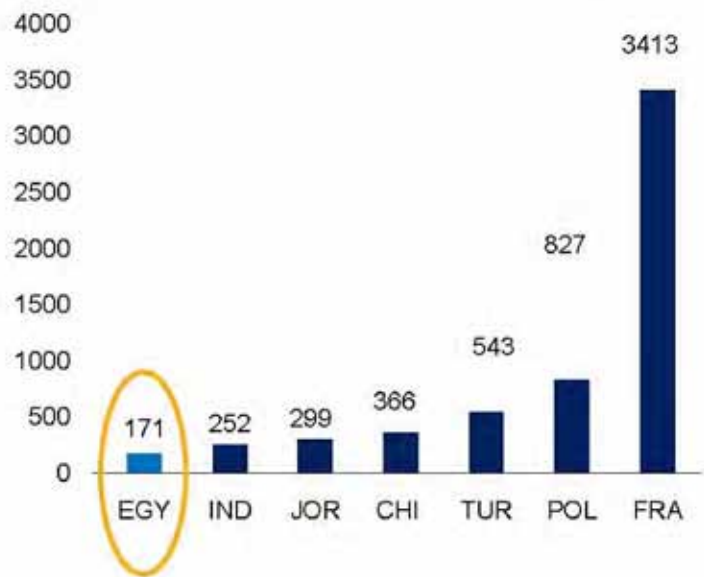

Unique location

Egypt's unique location and the advantage of being near to Europe with shipping time of **7 days maximum** and flying time of **4 hours maximum** gives **Edu-fun** factories in **Egypt** the privilege over their opponents at east Asia and China factories. This can save lots of time, money and create new opportunities.

Transportation Cost of 20 ft container to Europe in USD 2010

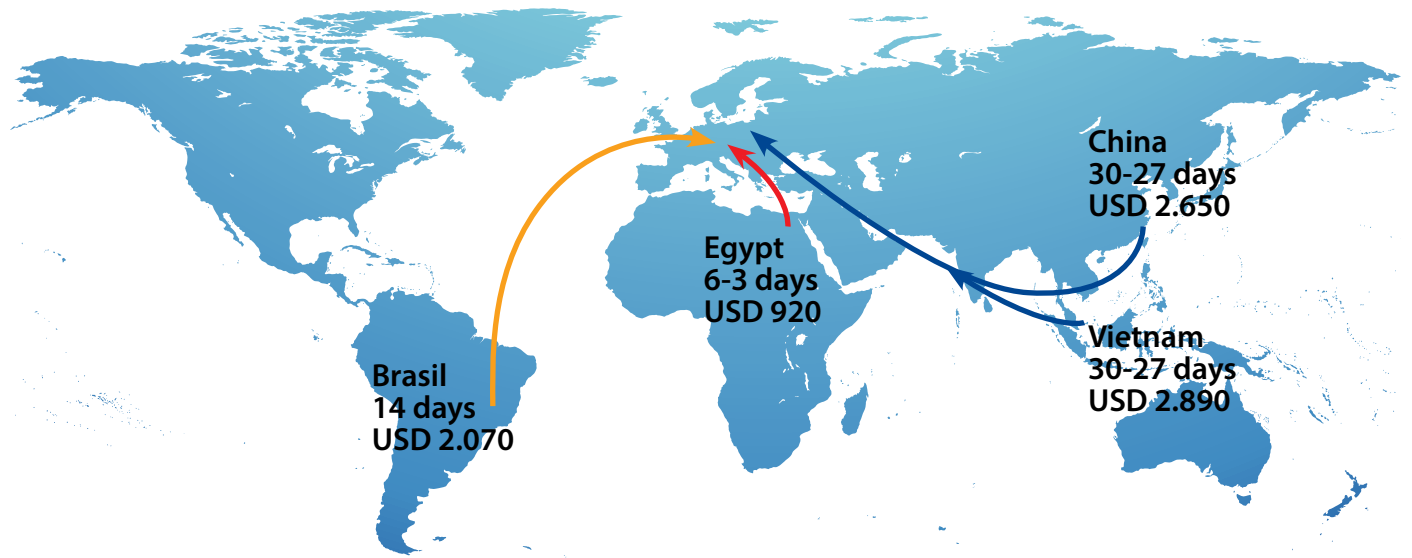
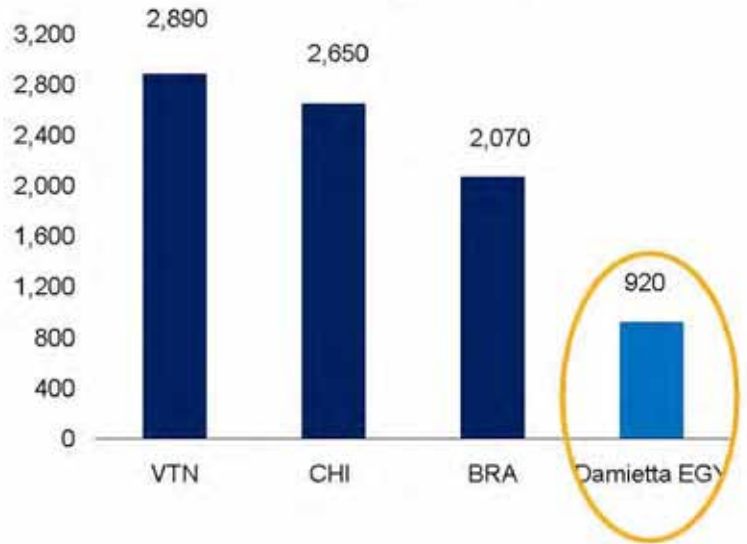

European material & standards

Edu-fun was the first factory in the world to import European materials such as (beech wood, plywood, paints) then process, manufacture and send them back to the European market and the case remains as it is. On the other hand, other countries using local cheaper options.

All of our products and production facilities are certified with international and Europe standers.



EN 71



ISO 9001
ISO 14001
OHSAS 18001



CE Edu-fun is a brand that guarantees compliance with the CE toys safety standards.



Wood is a natural bio degradable material that is most suitable material for children from the first months. All our products are designed and manufactured from the highest wood material from plantations for sustainable use. We also use non-toxic paints and lacquers.



Product is manufactured by European Materials.

Design & Manufactured by



Light Colored Beech Wood



In House Design



International
Standards
EN 71
CE

Non-Toxic Paints

Soft Edges

Safety Lacker
for Protection

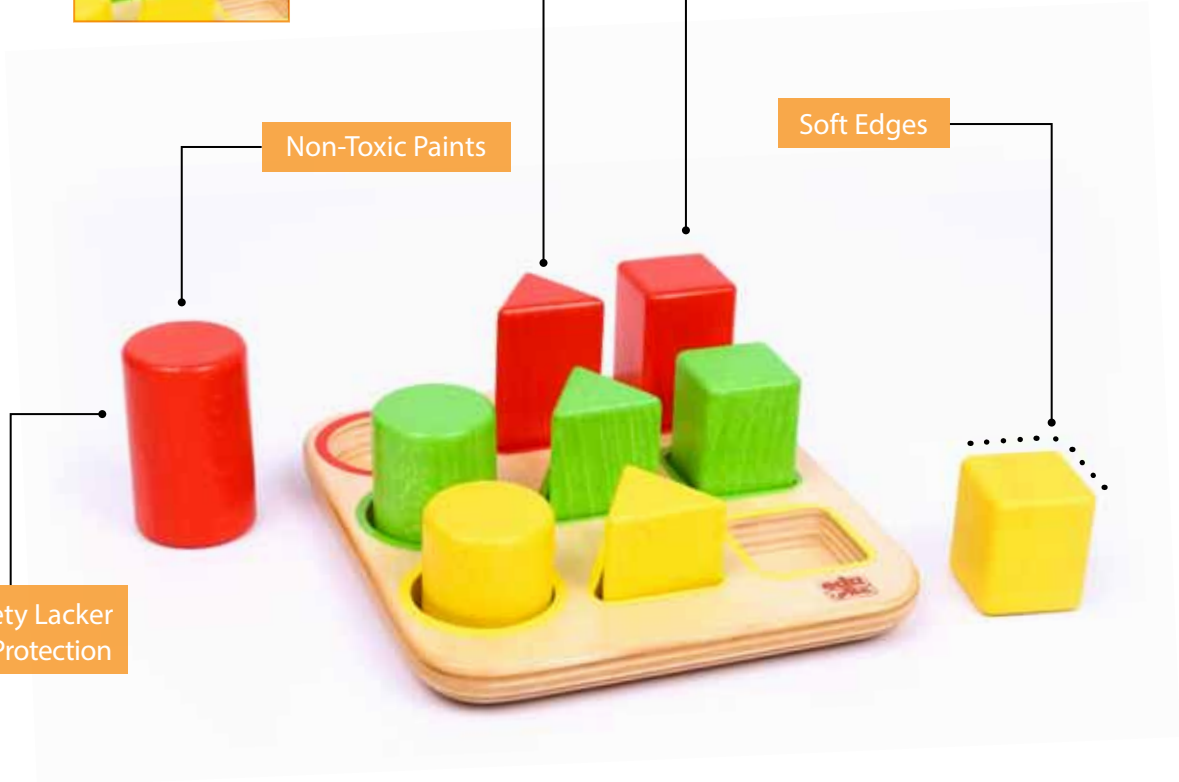

Handcraft Puzzle

Non-toxic Silk Screen
Directly on wood



Europe Origin Light
Colored Natural Wood

New products

We are proud to introduce 200 new products to our exiting range in 2017.

As a result of the smooth collaboration of international designers and our professional in house designers and engineers, we have new ranges in furniture and wooden toys, and finally our new Montessori collection.

Edu-fun, In the Celebration of 25 years of existence in the international market, thanks her current and new clients and promises to continue developing and improving to remain as it is as, the top manufacturer in the region.

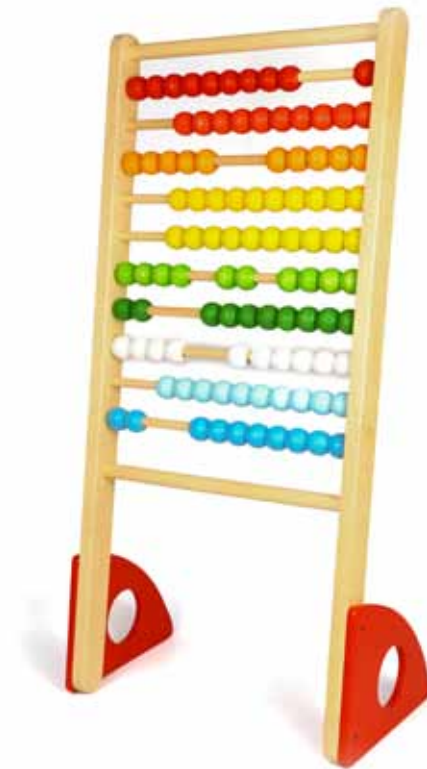

How to order

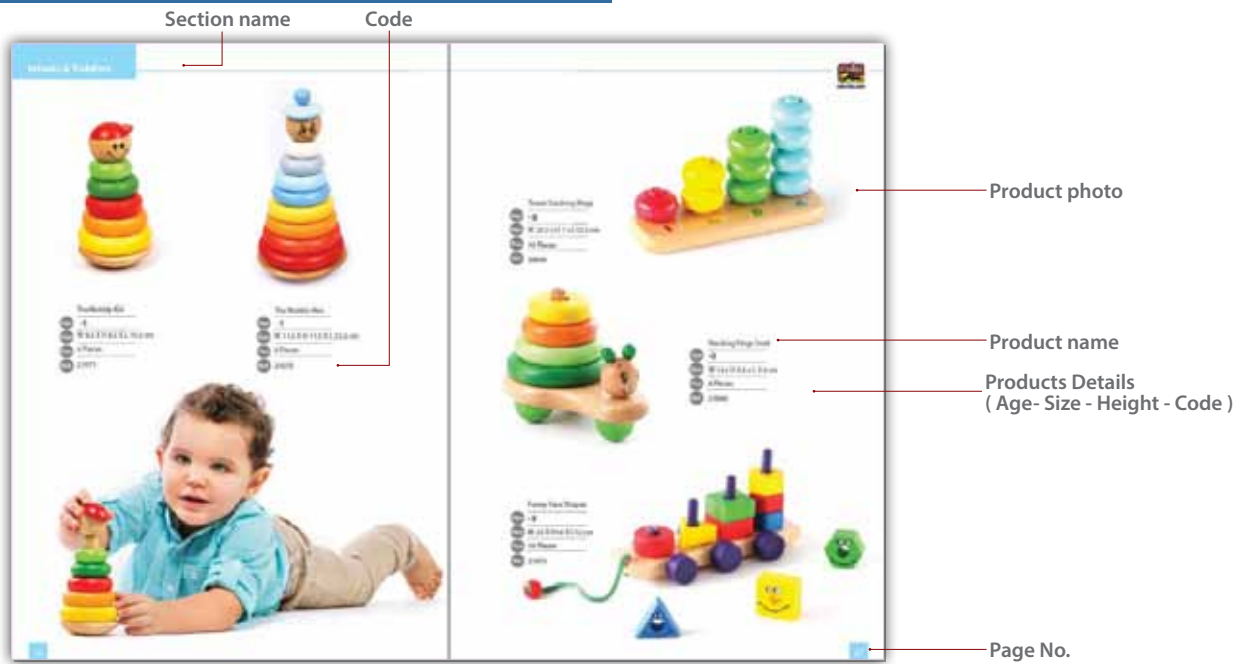

www.edu-fun.com

to know more about our services and projects, please visit us on: www.edu-fun.com



Infants & Toddlers

From the very beginning of life, children's curiosity is insatiable. They want to see, touch, taste and explore everything around them. What better than providing them with the tools to guide them in a safe, enjoyable way. We at Edu-Fun have the educational toys that are suitable to keep even the busiest of minds and hands satisfied as they explore their world.







Mini Building Blocks-Colored

- Age **+1**
- Size Basic Block Module : 3.5 cm
- Pcs 16 Pieces + 6 Pattrons
- Ref. 31311



Mini Building Blocks-Wooden

- Age **+1**
- Size Basic Block Module : 3.5 cm
- Pcs 16 Pieces
- Ref. 31310





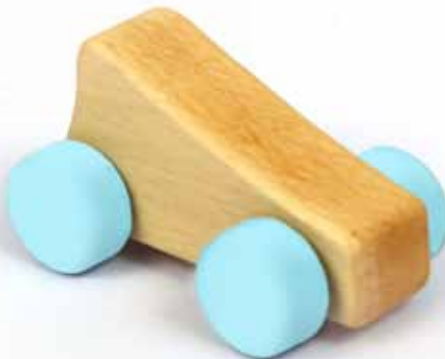

My Tiny Little Car

Age

+1

Size

W 7 X H 4 X L 4.6 cm

Ref.

22140





Crocodile



Bunny

Toddler Cute Animal Car

Age

+1

Size

W 7 X H 8.6 X L 4.8 cm

Ref.

Crocodile 22196 / Bunny 22197
Tiger 22195 / Cow 22198
Puppy 22199



Tiger



Cow



Puppy



Train



Van

Colored Cool Cars

Age +1

Size W 9.4 x 8.1 x 4.1 cm

Ref. Train 22192 / Van 22191 / Car 22190
Truck 22194 / School bus 22193



Car



Truck



School bus



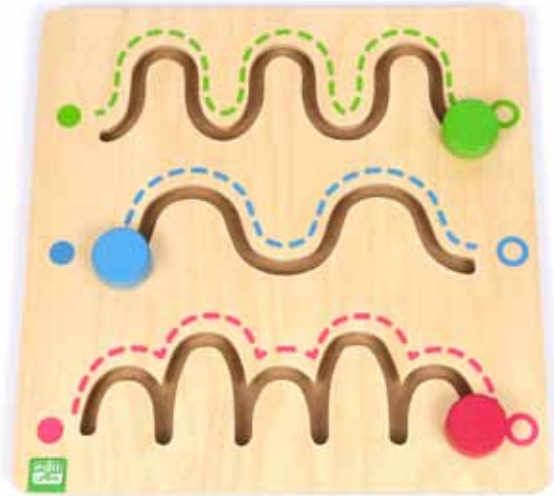

Lev 1



Lev 2



Lev 3



Toddler Tracking Board

Age +2

Size W 30 X H 30 X L 2 cm

Ref. (Lev 1) 21034 / (Lev 2) 21036
(Lev 3) 21038





Bird



Cat



Golden fish



Hen



Turtle



Rabbit



Parrot



Sheep

Playing With my ...

Age

+2

Size

W 21.3 x H 21.3 x L 0.9 cm

Pcs

4 Pieces

Ref.

Bird 11300 / Cat 11305 /
Hen 11310 / Golden Fish 11315
Trutle 11320 / Parrot 11325 /
Rabbit 11330 / Sheep 11335



The Wobbly Kid

- Age **+1**
- Size W 8.2 X H 8.2 X L 15.5 cm
- Pcs 6 Pieces
- Ref. 21071



The Wobbly Man

- Age **+1**
- Size W 11.5 X H 11.5 X L 23.5 cm
- Pcs 9 Pieces
- Ref. 21070



Tower Stacking Rings

- Age **+2**
- Size W 20.2 x H 7 x L 12.3 cm
- Pcs 10 Pieces
- Ref. 20040



Stacking Rings Snail

- Age **+1**
- Size W 14 x H 8.8 x L 9.4 cm
- Pcs 4 Pieces
- Ref. 21046

Funny Face Shapes

- Age **+2**
- Size W 23 X H 10 X L 12 cm
- Pcs 10 Pieces
- Ref. 21075





Shape Sorting Box

Age

+1½

Size

W 20.5 X H 12.8 X L 10 cm

Pcs

10 Pieces

Ref.

22085



Shapes Small Truck

Age

+1

Size

W 15 x H 12.4 x L 9.4 cm

Pcs

3 Pieces

Ref.

22071



Toddlers Grading Shapes

- Age **+ 2**
- Size W 14 x H 15.2 x L 6 cm
- Pcs 9 Pieces
- Ref. 21165



Junior 3D game

- Age **+ 2**
- Size W 18 x H 18 x L 4.8 cm
- Pcs 11 Pieces
- Ref. 10801



Screw Heads A

- Age +1½
- Size W 16 X H 6.5 X L 7.7 cm
- Pcs 6 Pieces
- Ref. 13020



Screw Heads B

- Age +1½
- Size W 16 X H 6.5 X L 7.7 cm
- Pcs 6 Pieces
- Ref. 13025



Nut & Bolt Butterfly

- Age +2½
- Size W 25.7 X H 25 X L 4 cm
- Pcs 10 Pieces
- Ref. 13000



Nut & Bolt Tree

- Age +2½
- Size W 25.7 X H 25 X L 4 cm
- Pcs 10 Pieces
- Ref. 13005





Surprise Window (Circles)

- Age +1
- Size W 32.5 x H 12.5 x L 3.3 cm
- Pcs 3 Pieces
- Ref. 10581



Surprise Window (Shapes)

- Age +1
- Size W 32.5 x H 12.5 x L 3.3 cm
- Pcs 3 Pieces
- Ref. 10576



Funny Circular Sorter

- Age +1
- Size W 25 x H 25 x L 2.9 cm
- Pcs 5 Pieces
- Ref. 21111



Funny Shapes Board

- Age +1
- Size W 25 x H 25 x L 2.9 cm
- Pcs 5 Pieces
- Ref. 21116



Star



Chick



Ladybird



Rabbit



Frog

Discover Who's Bigger ?

Age

+2

Size

30 x 8 x 1 cm

Pcs

4 Pieces

Ref.

Star 10524 / Chick 10520

Ladybird 10521/ Rabbit 10522

Frog 10523

Educational Toys

The early Pre-school years before formal education are the most formative for children. Their little minds are wide open and ready to accept any knowledge and information that they are subjected to. Edu-Fun believes that enhancing and advancing children's development during these crucial years is essential to build up strong foundation for a life-time of learning success. Edu-Fun has designed products for both pre-school and older children to help them explore and discover their world.





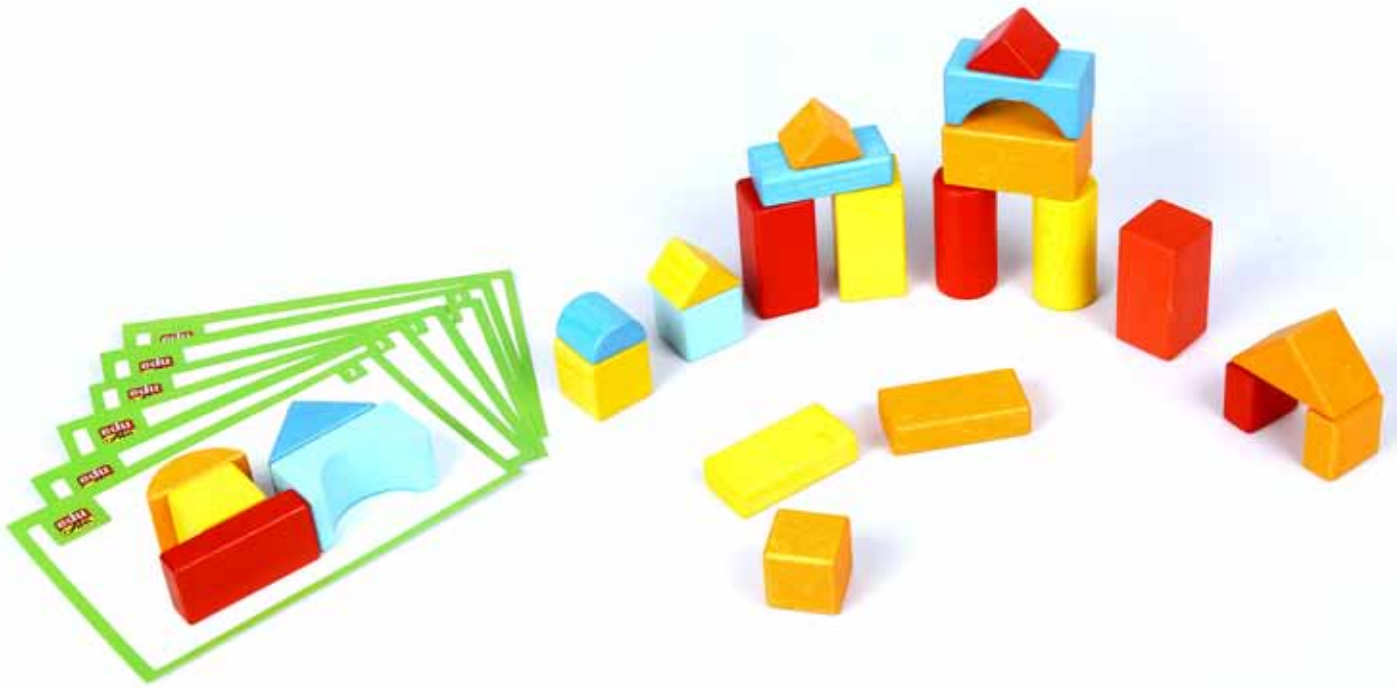

Basic Building Blocks-Colored

- Age +2½
- Size W 20.5 X H 12.8 X L 10 cm
- Pcs 25 Pieces + 6 patterns
- Ref. 31313



Basic Building Blocks-Wooden

- Age +2½
- Size W 20.5 X H 12.8 X L 10 cm
- Pcs 25 Pieces
- Ref. 31312



Large Building Blocks-Wooden

- Age +2½
- Size Basic Block Module : 3.5 cm
- Pcs 50 Pieces
- Ref. 31314









Large Building Blocks-Colored





- Age +2½
- Size Basic Block Module : 3.5 cm
- Pcs 50 Pieces
- Ref. 31315



Large Hollow Blocks

- Age **+5**
- Size Basic Block Module : 14 cm
- Pcs 17 pieces
- Ref. 31320

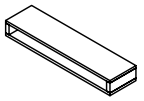
Large Hollow Blocks		
Shapes	Quantity	Size
	4	56 x 14 x 1.2 cm
	2	112 x 14 x 1.2 cm
	2	28 x 14 x 14 cm
	5	28 x 28 x 14 cm
	2	56 x 28 x 14 cm
	2	56 x 28 x 14 cm
Total	17	

Mini Hollow Blocks		
Shapes	Quantity	Size
	10	14 x 14 x 7 cm
	6	28 x 14 x 7 cm
	4	56 x 14 x 7 cm
	4	28 x 14 x 7 cm
Total	24	



Mini Hollow Blocks

Age

+3

Size

Basic Block Module : 7 cm

Pcs

24 pieces

Ref.

31322

* This Combi storage unit can accommodate our Large Hollow Blocks for organized, space saving and mobile storage.
Code **45520**





Colored window blocks

- Age **+3**
- Size Basic Block Module : 3.5 cm
- Pcs 24 pieces / Wooden Box
- Ref. 31325





Mirror Window Blocks

Age

+3

Size

Basic Block Module : 3.5 cm

Pcs

16 pieces / Wooden Box

Ref.

31330





Wild Animals



Farm Animals



Mealtime



Vegetables



Fruits

Insert Boards

Age

+3

Size

W 32.5 x H 20 x L 1.8 cm

Pcs

8 Pieces

Ref.

Wild Animals 10025 / Farm Animals
10020 Mealtime 10015 / Vegetables
10005 / Fruits 10000





Building Up Body Parts Puzzles (Girl)

- Age **+3**
- Size W 36.5 X H 25 X L 0.9 cm
- Pcs 21 Pieces
- Ref. 11530 (2 layers) / 11580 (3 layers)

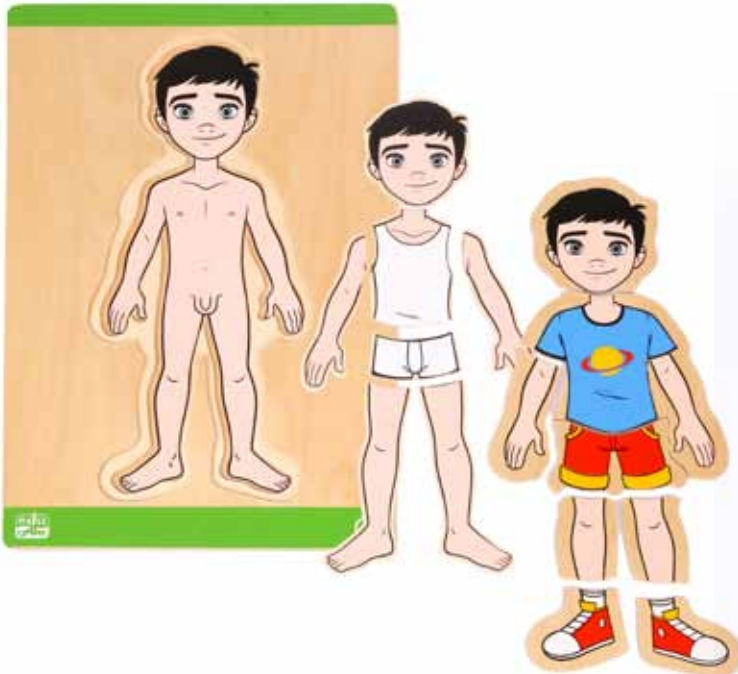

Building Up Body Parts Puzzles (Boy)

- Age **+3**
- Size W 36.5 X H 25 X L 0.9 cm
- Pcs 21 Pieces
- Ref. 11510 (2 layers) / 11525 (3 layers)



Know Your Face Puzzles Girl / Boy

- Age **+3**
- Size W 25 X H 25 X L 0.9 cm
- Pcs 8 Pieces
- Ref. **Girl 11540 / Boy 11535**





Sorting Box

Age

+3

Size

W 40 x H 12 x L 7.4 cm

Pcs

60 Pieces + 6 rulers

Ref.

31100





Small Sorting Box

Age **+3**

Size W 25 x H 12 x L 7.4 cm

Pcs 24 Pieces + 4 rulers

Ref. 31125





Shape sorting box

Age

+3

Size

W 25 x H 12 x L 7 cm

Pcs

16 Pieces + 8 rulers

Ref.

31135





Classification Box

- Age + 4
- Size W 25 x H 12 x L 7 cm
- Pcs 84 Pieces
- Ref. 31130



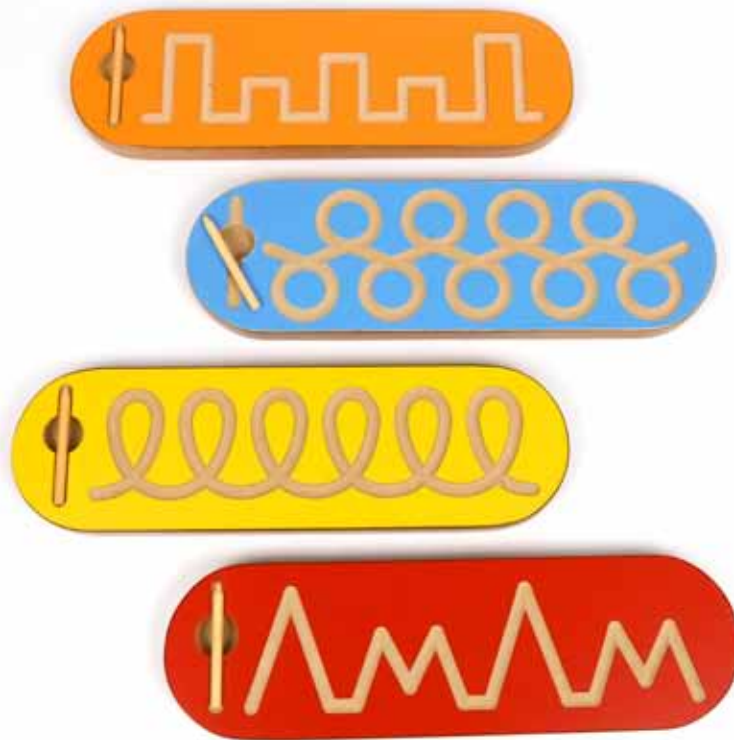

Pre-Writing Board Set

Age

+3

Size

W 33 x H 10 x L 1.8 cm

Ref.

21030





Follow the fish

- Age + 3½
- Size W 30 x H 30 x L 4 cm
- Pcs 12 Patterns
- Ref. 21025



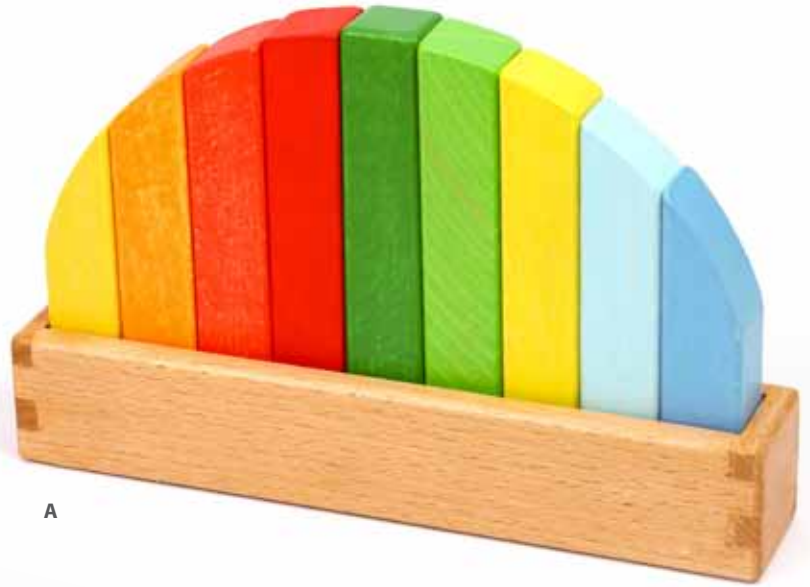

A

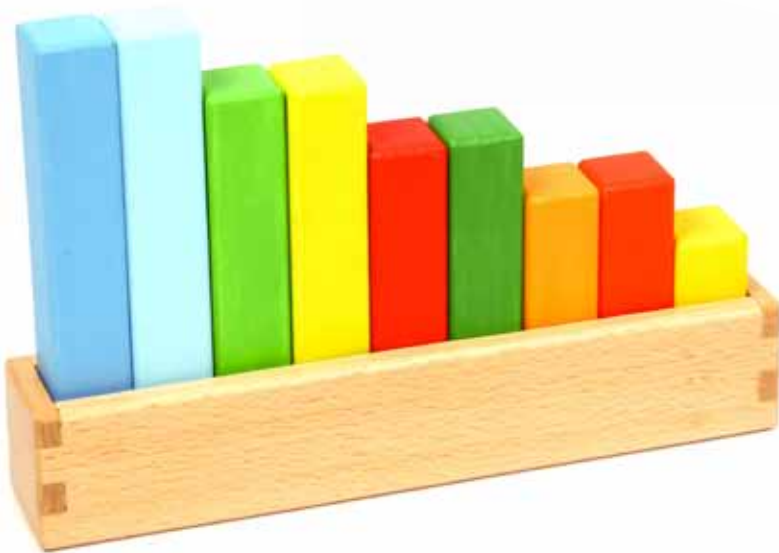

B



C

Which is the Tallest .. ?

Age

+3

Size

W 22.5 x H 14 x L 4.4 cm

Pcs

12 Pieces

Ref.

A 31250 / B 31255
C 31260



Popcorn Balance Game

- Age +4
- Size W 12.5 x H 6 x L 2 cm
- Pcs 21 Pieces
- Ref. 22405





Geometrical peg Grading Board

Age

+3

Size

W 21.5 x H 21.5 x L 8.5 cm

Pcs

16 Pieces

Ref.

21155





Shape Matching Board

Age

+ 4

Size

W 21.5 x H 21.5 x L 3.5 cm

Pcs

18 Pieces

Ref.

21105



Geometric Fractions

Age

+ 4

Size

W 32 x H 9.5 x L 4 cm

Pcs

10 Pieces

Ref.

21100



Colored Big Blocks

- Age **+3**
- Size W 38.1 x H 35.7 x L 30.8 cm
- Pcs 193 Pieces
- Ref. 31390



















No.	Shape	Quantity	Size
1		18	35 x 35 x 35 mm
2		16	7 x 35 x 35 mm
3		8	105 x 35 x 35 mm
4		2	175 x 35 x 35 mm
5		24	35 x 35 x 17.5 mm
6		4	70 x 35 x 17.5 mm
7		18	105 x 35 17.5 mm
8		10	210 x 35 x 8.75 mm
9		8	70 x 70 x 35 mm
10		8	105 x 35 x 35 mm
11		14	7 x 35 x 35 mm
12		20	35 x 35 x 17.5 mm
13		9	70 x 35 Rmm
14		6	35 x 35 Rmm
15		11	70 x 35 x 35 mm
16		11	525 x 35 17.5 mm
17		1	140 x 70 x 35 mm
18		1	70 x 35 x 35 mm
19		4	70 x 35 x 35 mm
Total Quantity		193	



Natural Big Blocks

- Age** +3
- Size** W 70 x H 100 x L 40 cm
- Pcs** 183 Pieces
- Ref.** 31385



No.	Shape	Quantity	Size
1		30	70 x 70 x 35 mm
2		27	140 x 70 x 35 mm
3		9	280 x 70 x 35 mm
4		9	280 x 70 x 11 mm
5		12	140 x 35 x 35 mm
6		6	140 x 70 x 35 mm
7		6	70 x 70 x 35 mm
8		36	70 x 70 x 35 mm
9		3	140 x 70 x 35 mm
10		3	70 x 35 x 35 mm
11		6	140 x 70 x 35 mm
12		6	140 x 70 x 35 mm
13		3	280 x 210 x 35 mm
14		3	180 x 70 x 35 mm
15		12	140 x 35O mm
16		6	140 x 70 x 35 mm
17		6	70 x 70 x 35 mm
Total Quantity		183	

* This Flexi storage unit can accommodate our Natural big blocks for organized, space saving and mobile storage.
Code **64045**



Grading circular tower

- Age **+3**
- Size W 7 × H 7 × L 21.5 cm
- Pcs 7 Pieces
- Ref. 21187



Stacking shape tower

- Age **+3½**
- Size W 7 × H 7 × L 21.5 cm
- Pcs 7 Pieces
- Ref. 21188





Goldilocks and the Three Bears



Pinocchio



Hansel and Gretel



Little Red Riding Hood

Fairy Tales

Age + 4

Size W 19 x H 26 x L 5.5 cm

Pcs 9 Pieces

Ref. Goldilocks and the Three Bears 21225
Pinocchio 21220 / Hansel and Gretel 21235
Little Red Riding Hood 21230



Where is My Button?

Age

+ 4

Size

W 33 × H 18 × L 4.5 cm

Pcs

32 Pieces + 8 patterns

Ref.

30582



Color hunt

Age

+4

Size

W 16.5 × H 16.5 × L 5.5 cm

Pcs

22 Pieces

Ref.

30583





Squared Domino

Age

+3

Size

W 5.5 x H 5.5 x L 16.5 cm

Pcs

28 Pieces

Ref.

31026



Taking a Bath



Waking Up



Running



Drinking



Sleeping



Eating



Reading



Playing

What are You Doing ?

Age

+ 4

Size

W 21.3 x H 21.3 x L 0.9 cm

Pcs

9 Pieces

Ref.

Taking a Bath 11980 / Waking Up 11985
 Running 11975 / Drinking 11960
 Sleeping 11965 / Eating 11970
 Reading 11955 / Playing 11950



Trip to Circus

- Age **+4**
- Size 29.5 x 20 x 12 cm
- Pcs 20 Pieces + 20 Patterns
- Ref. 10805



Trip to Farm

- Age + 4
- Size 29.5 x 20 x 12 cm
- Pcs 20 Pieces + 20 Patterns
- Ref. 10800



Geometrical domino



Animals domino

Touch and match dominos

Age

+3

Size

W 37.5 x H 23 x L 3.6 cm

Pcs

28 Pieces

Ref.

Geometrical domino 31035
Animals domino 31040



Wild Animals



Farm Animals

New look Picture Domines

- Age +4
- Size 37.5 x 23 x 3.6 cm
- Pcs 28 Pieces
- Ref. Farm Animals 31030
Wild Animals 31025



Colour Mosaic

- Age +4
- Pcs 60 Pieces
- Ref. 31220

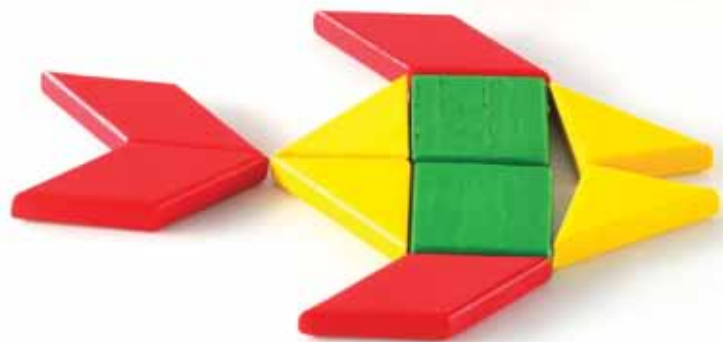
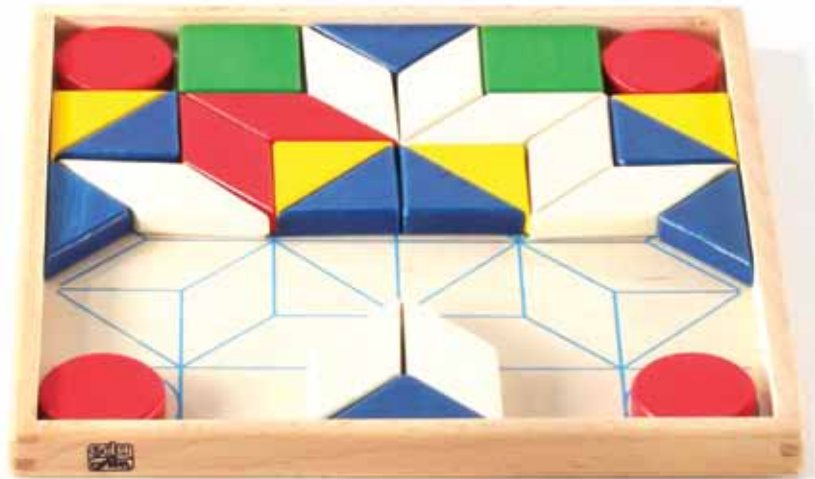

Shapes Mosaic

- Age +4
- Size W 28 x H 28 x L 1.9 cm
- Pcs 44 Pieces
- Ref. 31205



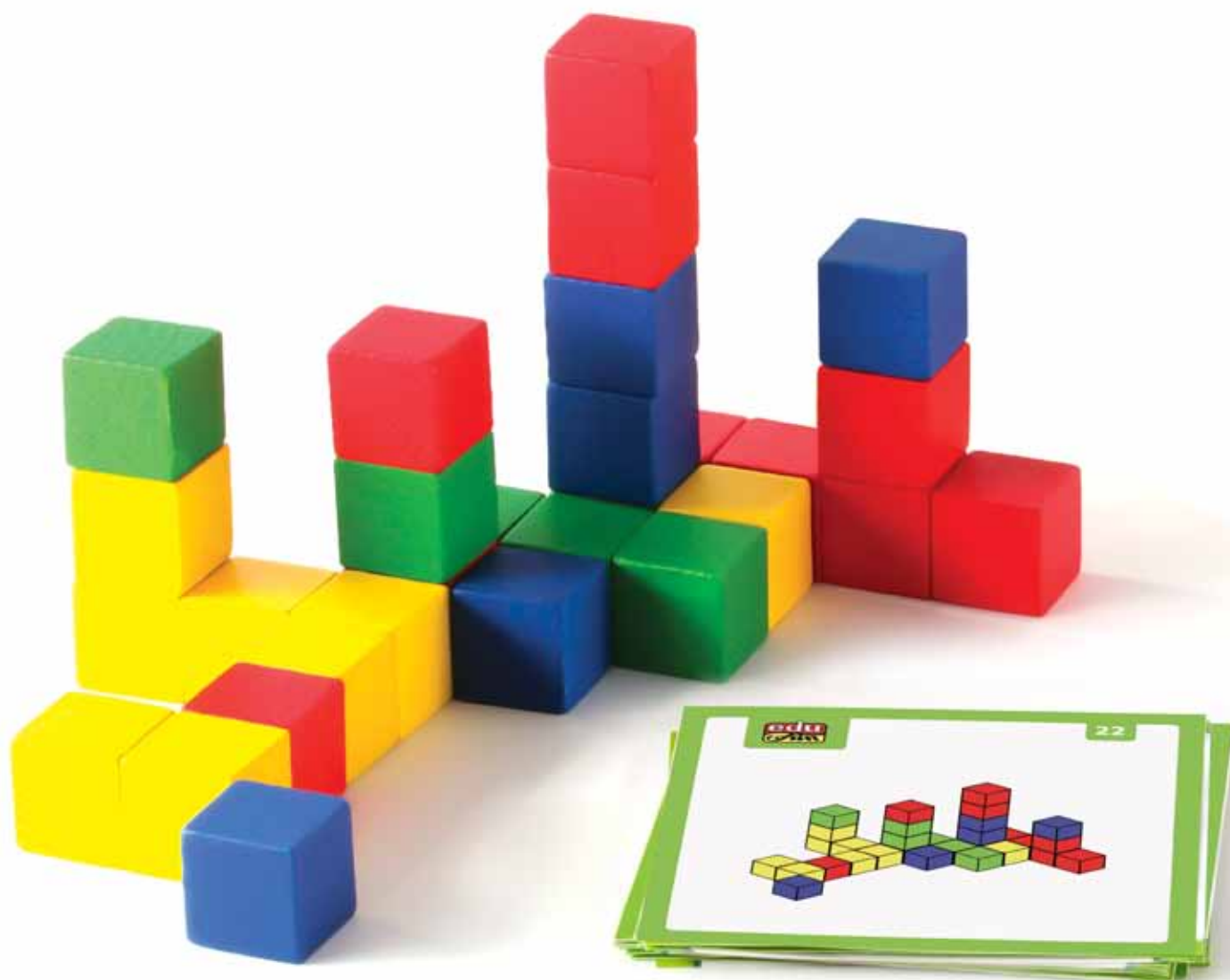

3D Cubes

Age

+6

Size

W 2.5 x H 2.5 x L 2.5 cm

Pcs

64 Pieces

Ref.

31370



Letters & Numbers

It's essential when your child begins to learn the letters & numbers of a language that he does it in an enjoyable way. This could be done in many ways but what could be easier and more fun than learning the alphabet and numbers the Edu-Fun way ! We have a variety of games & puzzles to help your child recognize his letters and numbers in an easy and delightful way.







Build Up Abacus

Age

+3

Size

W 24.7 x H 23.7 x L 5.5 cm

Ref.

20010





Giant Toddler Abacus

Age

+2

Size

W 44.5 × H 24 × L 90 cm

Ref.

20007



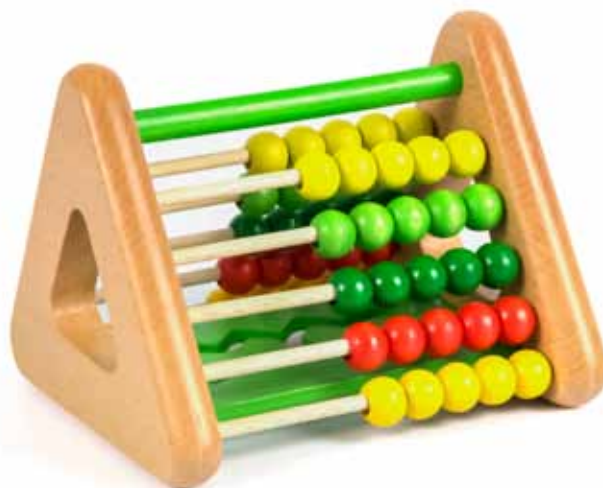

Triangle Abacus & Tracing

Age **+3**

Size W 14.5 X H 14.5 X L 13 cm

Ref. 20060



Counting Abacus

Age **+3**

Size W 24.3 X H 5.5 X L 23.5 cm

Ref. 20070





Number Board

- Age **+3**
- Size W 32.5 X H 20 X L 0.9 cm
- Pcs 10 Pieces
- Ref. 12055



What's Inside My Numbers?

- Age **+3**
- Size W 32.5 x H 20 x L 0.9 cm
- Pcs 10 Pieces
- Ref. 12075



Play & Learn Alphabet

- Age **+3**
- Size W 33 X H 18 X L 4.7 cm
- Pcs 52 Pieces
- Ref. 32005



Spell - A - Word?

- Age **+3**
- Size W 33 X H 18 X L 4.7 cm
- Pcs 33 Pieces
- Ref. 32025



Alphabet Board - Capital

- Age 3
- Size W 36.5 X H 25 X L 0.9 cm
- Pcs 26 Pieces
- Ref. 12005



Alphabet Board - Small

- Age 3
- Size W 36.5 X H 25 X L 0.9 cm
- Pcs 26 Pieces
- Ref. 12010



What's Inside My Alphabet?

- Age 3
- Size W 36.5 X H 25 X L 0.9 cm
- Pcs 26 Pieces
- Ref. 12020

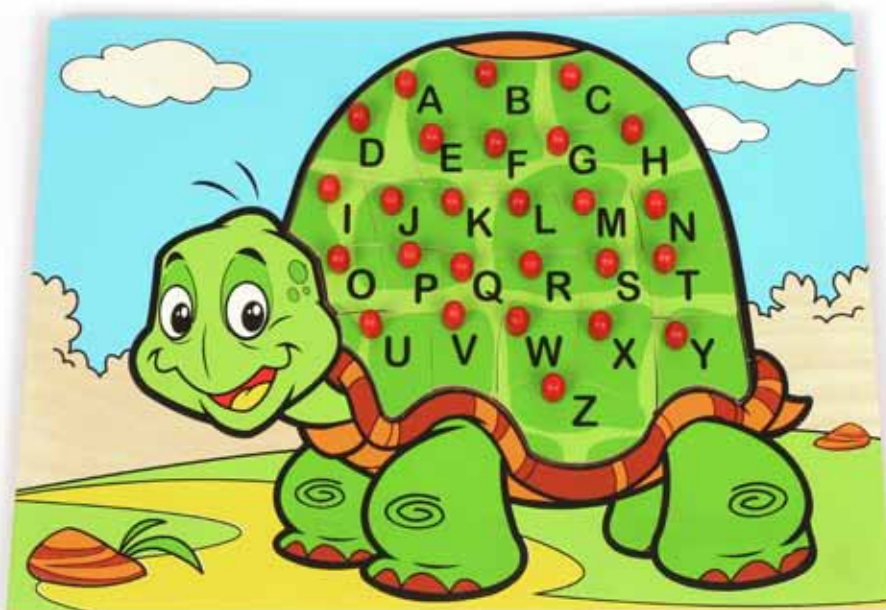

Turtle

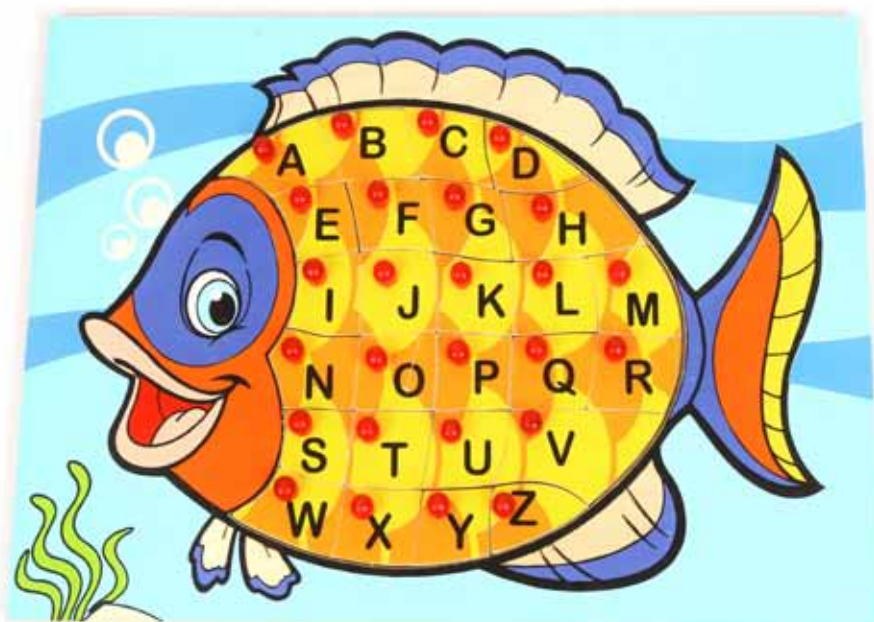

Fish

Letter Puzzle

Age **+ 3**

Size W 36.5 x H 25 x L 1.8 cm

Pcs 26 Pieces

Ref. Turtle 12115 / Fish 12105

Dramatic Play

Step into the world of a child's imagination, playing house, going shopping, having a tea party for a favorite teddy or playing doctor for an injured doll. Children have a very clear sense of imagination and dramatic play tools enhance this sense at the same time breaking down walls of shyness as they role-play different characters. Whatever the game of pretend they've conjured up we have the toys, kits, puppets and scaled down models which help their imagination to come alive.







Modern Theater

Size W 91 X H 35 X L 167 cm

Ref. 21560



Fun Pretend Iron Set

Size W 16.4 x H 10.3 x L 10 cm

Size W 82.5 x H 28 x L 55 cm

Ref. 21565



Fun Pretend Clothes Rack

Size W 55.3 X H 34 X L 55.3 cm

Ref. 21570



One unit Pretend Kitchen

Size W 40 x H 112 x L 105 cm

Ref. 21660



Sink Washing Machine



Fridge



Cooker

Children Play Kitchen

- Size Sink Washing Machine W 40 X H 40 X L 52 cm
- Size Cooker W 40 X H 40 X L 52 cm
- Size Fridge W 40 X H 40 X L 85 cm
- Ref. Sink Washing Machine 21606 /
Cooker 21601 / Fridge 21616





The Wobbly Man small P.26



The Wobbly Man P.26

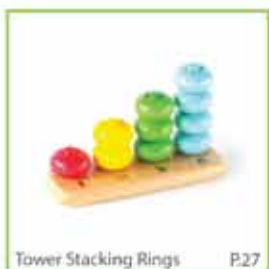

Tower Stacking Rings P.27



Stacking Rings Snail P.27

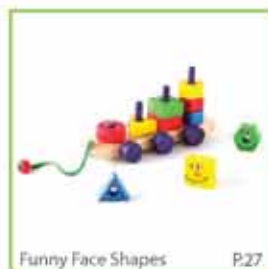

Funny Face Shapes P.27



Shape Sorting Box P.28



Shapes Small Truck P.28



Toddlers Grading Shapes P.29



Junior 3D game P.29



Screw Heads A P.30



Screw Heads B



Nut & Bolt - Butterfly P.30



Nut & Bolt - Tree P.30



Surprise Window - Circles P.32



Funny Face Shapes P.32



Funny Circular Sorter P.32



Funny Shapes Board P.32



Discover Who's Bigger ? P.33



Discover Who's Bigger ? P.33



Discover Who's Bigger ? P.33



Discover Who's Bigger ? P.33



Discover Who's Bigger ? P.33



Basic building blocks-colored P.36



Basic building blocks-wooden P.36



Large building blocks-wooden P.37



Large building blocks-colored P.37



Large Hollow Blocks P.38



Mini hollow blocks P.39



Colored window blocks P.40



Mirror Window Blocks P.41





Where is my button? P.60



Color hunt P.61



Squared Domino P.62



Taking a Bath P.63



Waking Up P.63



Running P.63



Drinking P.63



Sleeping P.63



Eating P.63



Reading P.63



Playing P.63



Trip to ... Circus P.64



Trip to ... Farm P.65



Geometrical Domino P.66



Animals Domino P.66



Wild Picture Domino P.67



Farm Picture Domino P.67



Colour Mosaic P.68



Shapes Mosaic P.68



3D Cubes P.70



Build up abacus P.74



Giant Toddler Abacus P.75



Triangle Abacus & Tracing P.76



Counting Abacus P.76



Number Board P.78

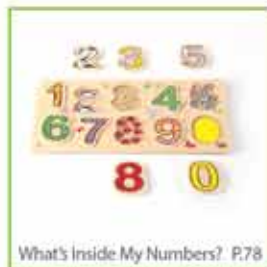

What's inside My Numbers? P.78



Play & Learn Alphabet P.79



Spell - A - Word? P.79



Alphabet Board / Capital P.80



Alphabet Board / Small P.80

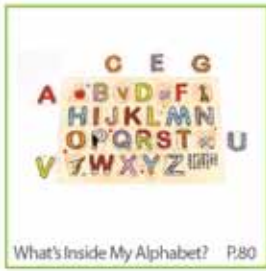

What's Inside My Alphabet? P.80



Letter Puzzle Turtle P.81



Letter Puzzle Fish P.81



Modern Theater P.84



Fun Pretend Iron Set P.85



Fun Pretend Clothes Rack P.85



One unit Pretend Kitchen P.86



Fridge P.87



Sink Washing Machine P.87



Cooker P.87



■ **Head Office**

Dubai, UAE

- *GCC Marketing*
 - *GCC Sales & Distribution Center*
 - *Showroom & Outlet Warehouse*
- Building C, Office No. 259,
Business Park, Dubai World Central,
Dubai, UAE

UAE Showroom

No.1, ASAS Building, Maliha Rd
Industrial Area 18, Sharjah, UAE
Tel: +971 6 556 8255, Fax: +971 6 556 8334
Cell: +971 50462 2134,
uae@edu-fun.com

■ **MENA Region Subsidiary**

Cairo, Egypt

- *Marketing Office*
- *Production Facilities*
- *Showroom & Outlet Warehouse*
- *MENA Region Distribution Center*

No. 27 Mohammed Tawfik Diab
Makram Ebied, Nasr City
Cairo, Egypt
Tel: + 202 227 07 649
Fax: + 202 227 07 571
egypt@edu-fun.com

■ **Saudi Arabia Subsidiary**

Riyadh, Saudi Arabia

- *Marketing & Sales Office*
- *Showroom & Warehouse*
- *Saudi Arabia Distribution Center*

Al Solaymania, Al Dabab St.,
Riyadh, Saudi Arabia
P.O. Box : 61810
Tel: +966 114 629 654
Cell : +966 50 750 4494
ksa@edu-fun.com

■ **Australia & Oceania Subsidiary**

Melbourne, Australia

Level 24, 570 Bourke Street
Melbourne,
Victoria 3000
Australia
Tel.: 1300-EDUFUN
Tel: + 61 402 266 852
aus@edu-fun.com

www.edu-fun.com

Ask for more 2017 catalogues



Kindergarten Furniture



Natural Line Furniture



Montessori materials



Head Office
Dubai, UAE

Building C, Office No. 259, Business Park, Dubai World Central

Showroom
Sharjah, UAE

No.1, ASAS Building, Maliha Rd, Industrial Area 18

Tel: +971 6 556 8255, Cell: +971 50462 2134

uae@edu-fun.com, www.edu-fun.com