



2018 - 2019





Introduction	04
Infants & Toddlers	16
Arts & Crafts	28
Educational Toys	54
Language	78
Mathematics	86
Montessori	96
Oriental Products	116
Dramatic Play	122
Educational Posters	132
Educational Carpets	138
Energetic play	148
KG Furniture	164
Safety Products	262

Contributing to Education

Edu-Fun contribution to the educational equipment field as a manufacturer and a supplier goes for more than 15 years. We have been providing children all over the world with toys and educational furniture that stimulate their imagination, increase their knowledge and enhance their mental and physical development. This comes from our belief that a well-established learning environment is a main factor in the success of the educational process and an important tool in the development of the child's self-confidence, intelligence and creativity.



Since 2000



New Showroom 2016

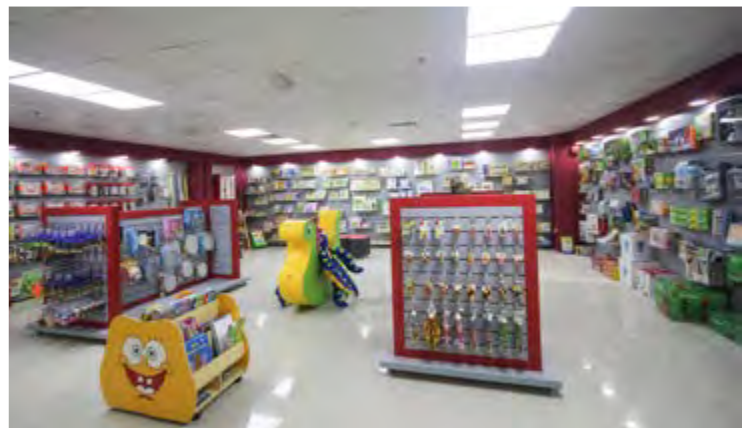
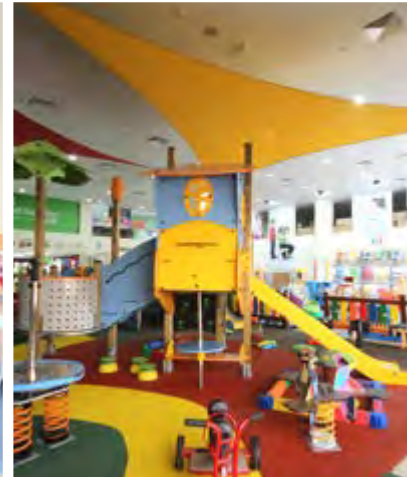

International Quality - Safety - Standards

Product safety is the basic requirement for us. Safety is ensured in all products which are complying with the international safety and quality standards.

International Standards BS EN1729

Chairs & Tables Heights & Colors Symbol

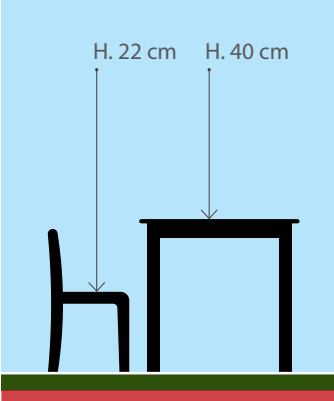
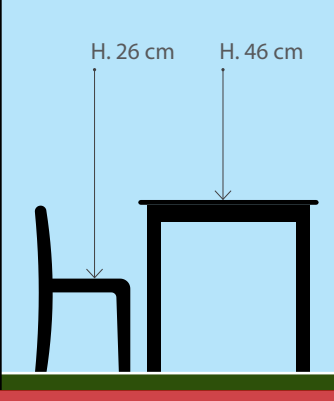
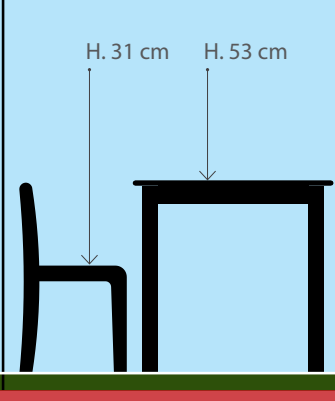
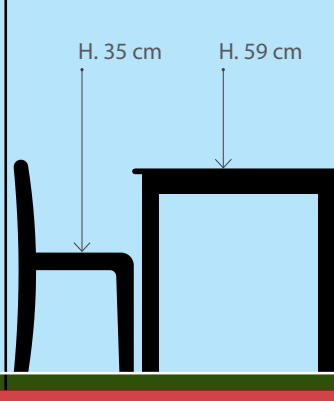
C0 Nursery 1	C1 Nursery 2	C2 K.G. 1	C3 K.G. 2
 <p>H. 22 cm H. 40 cm</p>	 <p>H. 26 cm H. 46 cm</p>	 <p>H. 31 cm H. 53 cm</p>	 <p>H. 35 cm H. 59 cm</p>



ISO 9001
ISO 14001
OHSAS 18001



Deep-rooted is gold:

Edu-Fun is a leader in the educational field, so cooperation only occurs with well-chosen international companies that are well known with their products quality that comply with the international standards for child safety. Most of our partners are Deep-rooted companies with long experience in their field. These long years of experience guarantee having the best products in their field.



From 120 Years



From 50 Years



From 40 Years



From 40 Years



From 30 Years



From 25 Years



From 25 Years



From 25 Years



From 15 Years

International Entities

We **-Edu Fun-** as a supplier represent key educational brands and products from all over the world such as Gratnells, Proludic, Arte Viva, Codex srl, Henbea, Learning Carpets, Edx Education, SBM, Beleduc develop, Lutz mauder and deliver their unique educational resources to GCC markets. All these specialized international entities can cover schools various fields requirements such as arts & crafts, posters and school furniture.



Introduction



In stock products

We have the products you need, always when you need them! Our huge warehouse enables us to have products in stock, so you will not deal with shipping hassles.



Competitive prices:

We believe that Middle East is in an intense need for these products to improve the educational standards. In order to bring it to this market with the most competitive prices we get it directly from the source producing company.



New products

We are proud to introduce 200 new products to our exiting range. As a result of the smooth collaboration of international designers and our professional in house designers and engineers, we have new ranges in furniture and wooden toys, and finally our new Montessori collection. All of our products and production facilities are certified with international and Europe standers. Edu-Fun thanks, In the Celebration of more than 15 years of existence in the international market, its current and new clients for their trust and promises to continue developing and improving to bring them the best quality products.



Educational Furniture & Supplies from Top International Brands

Edu Fun is providing children around the world with toys and educational furniture that stimulate their imagination, increase their knowledge and enhance their mental and physical development. We believe that a toy should not only be for plaything but an important tool in the development of a child's self - confidence, intelligence and creativity.

Edu Fun represents key educational brands around the world and delivers their unique educational resources to GCC markets. Our brands cover all of the requirements of a school.

 <p>UK</p>	<p>Gratnells is the world leader in school storage solutions. We design, develop and manufacture award-winning storage systems for the educational market. Three million trays are produced every year (and sent to over 68 countries around the world) from our 10,000 square meter, 24-hour production, advanced-technology factory in Harlow, Essex.</p>
 <p>Denmark</p>	<p>Gonge inspires and motivates children to be physically active. For 50 years, gonge have developed products that stimulate children's physical, cognitive, social and emotional development while having fun. Gonge merged with Winther on the 1st of July 2010. Gonge and Winther supply kindergartens and schools globally, as well as private families. The brands' product ranges complement one another to offer a great variety of ways for children to play, move and learn.</p>
 <p>Australia</p>	<p>Australia's leading wholesaler of education, art and craft products. Manufacturers, designers and wholesalers to school suppliers and retail stores both in Australia and in 30 countries around the world with over 30 years experience.</p>
 <p>Netherlands</p>	<p>Arte Viva is a dynamic Dutch company specialized in innovative niche child safety products. It was started in the year 2000, are being sold in over 60 countries on 6 continents. Arte Viva produces its products mainly in the Netherlands, Germany and Belgium. Some production is in the Far East.</p>
 <p>Italy</p>	<p>Codex srl on the market for over 40 years, research studies and realizes original protections made of Polymat and Maxionda, security primarily in school and sports field without neglecting the importance of the safety of the home environment With its production, Codex is able to satisfy the many requests for securing any type of fixed or movable components that represent a danger: GUARDS tailored for indoor and outdoor use, CORNER, HOT DOG and STRIPES BUMPER in Polymat, flexible panels in MAXIONDA (suitable for any type of support, linear or complex form), WALL MAT fireproof protection for large walls)</p>
 <p>Spain</p>	<p>Henbea has been designing & Manufacturing Educational Materials & games for children for more than 25 years, making learning more exiting through play, espacially for those with special needs. Henbea Has evolved over the years , using original illustrations to develop materials for specific educational purposes & responding to the needs of schools,teachers,children & parents. All our products have been manufactured at our own factory in spain by qualified personnel & they all comply with the european EN71 standard. All Henbea products are made of long-lasting washable plastics.</p>

 <p>USA - Belgium</p>	<p>By combining education and play value in all of our products, we at Learning Carpets have been able to create this superb line of quality, educational play carpets and award winning toys. Learning Carpets products are great learning tools for use as daycare rugs and classroom rugs.</p>
 <p>Australia- Taiwan</p>	<p>Edx Education is an international supplier of quality educational products and materials to customers throughout the world. The company was established in Taiwan in 1996 and the principals have more than 35 years experience in the education industry.</p>
 <p>Germany</p>	<p>SBM is a modern family company with tradition and future. As a worldwide manufacturer of school and lunchroom furniture SBM offers a wide range of flexible items for the education, corporate, healthcare, government and public Sectors. From our Mobile Table ,Seating Systems, Mobile stages, MOVITS Mobile and folding room dividers, choral risers and our SCHUKI Chilling Bags have been offering a host of innovative products that can transforming environments improving results in which deliver the quality that fulfill the functional needs of different facilities and guarantees the influence and creative background and precision of German engineering and know how.</p>
 <p>Germany</p>	<p>The lovable hand puppets with their high educational value have already made themselves at home in children's rooms, nurseries, schools and countless therapeutic institutions. We are happy and proud that the living puppets have become a part of the life for so many people for over 15 years now.</p>
 <p>Germany</p>	<p>Born in 1960 in the town of Heinsberg Lutz is a freelance artist since 1982, Early on, he developed two distinctive schools of art. On the one hand, his cheeful and colourful illustrations that have given hundreds of publishing items their unique look. On the other hand, his naturalistic aquarelle paintings. Each image is drawn with lots of attention for details with brush & paint also made in Lutz' Self-developed proprietary technique to give creative work representing the old & new, yesterday & tomorrow, young & old moods & emotions vibrate within his creations . His Illustrations permit us to put our worries aside for a moment and put a smile into our face.</p>
 <p>Germany</p>	<p>"Inspiration in Education" that's what Vinco stands for. Vinco is a member of the Betzold group, the leading educational wholesale company for educational materials in Germany. Our team of teachers and professional designers create a vast amount of novelties every year to provide interesting products for school and kindergarten.</p>
 <p>Poland</p>	<p>Since its foundation in 1992 Nowa Szkoła has been persistent and consistent in promoting and creating a friendly educational environment. Their main addressees are always children; therefore, priorities – from project to product – are safety, quality and development.</p>
 <p>UK</p>	<p>Through acquisition and development Spaceforme have become known to have the best educational chair range in the UK. Their vision was to deliver a practical furniture range that is durable, aesthetically pleasing and affordable for the enhancement of the user's environment. With committed Spaceforme seating has for many years been sat on by millions of people in Schools, Colleges, Universities, Hospitals and many other public facilities.</p>

Multiple Intelligences

Are all children intelligent? Intelligence is often defined as our intellectual potential; something we are born with, something that can be measured and a capacity that is difficult to change. Recently, however, other views of intelligence have emerged. One such conception is the theory of multiple intelligences proposed by Harvard psychologist Howard Gardner which has become a touchstone of education. Embracing a wide array of human talents that significantly contribute to our intellectual and cultural life, MI theory offers a broader definition of intelligence than is measured by standard IQ tests.

nobody's good at them all. With the right toy or educational aid children can improve their weak types of intelligences and become really good in all areas.

Gardner suggests that people do not have just an intellectual capacity, but have many different intelligences in order to capture the full range of abilities and talents that people possess.

He believes – and we do – that everybody has a different mind, and no two profiles of intelligence are the same.

Gardner indicates that by introducing a broader range of learning methods, (known as the intelligences) educators and indeed parents, can home in on an individual's strengths and weaknesses by determining their preferred learning style.

This would consequently give them the opportunity to learn productively in ways more to their unique minds. "If a child is not learning the way you are teaching, then you must teach in the way the child learns." (Rita Dunn).



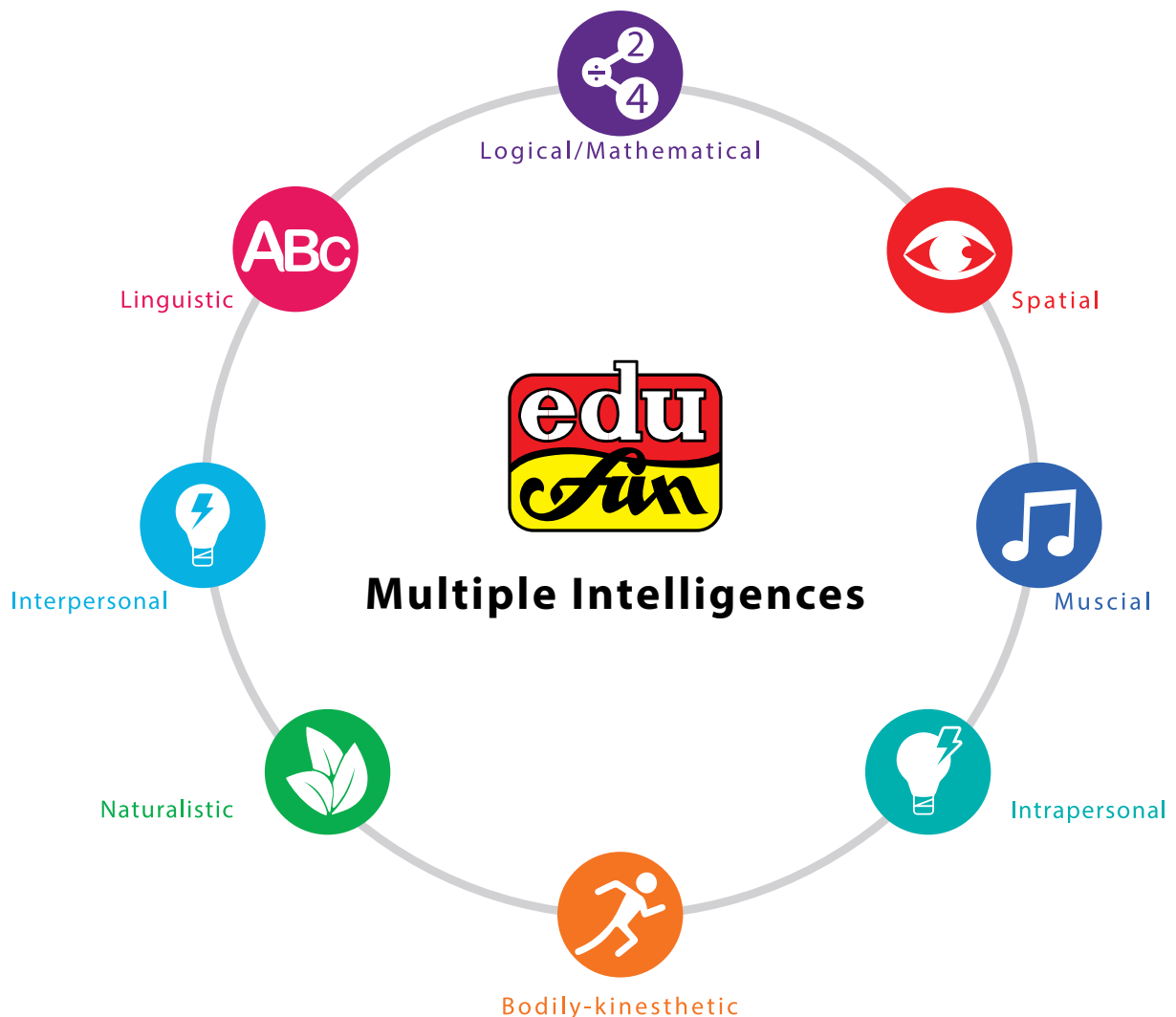





As for Gardner there are 8 primary intelligences. An individual may excel in one, two or even three of these, but nobody's good at them all. With the right toy or educational aid children can improve their weak types of intelligences and become really good in all areas.





To know the meaning of the symbols used in this catalogue please refer to **the Intelligences Chart**.

Multiple Intelligences

These symbols are designed to help you understand the Multiple Intelligences that our toys can help your child develop.

	Logical/Mathematical Intelligence help your child to recognize and understand the value of numbers, develop thinking and problem solving.
	Linguistic skills are essential for developing different skills, as the child's benefit by his experiences will be limited without him being able to understand and express himself.
	Naturalistic intelligence helps children to know and understand the Nature around them, and develops exploring the environment and learning about other species.
	Intrapersonal intelligence is essential for living happily in a family, cooperating, making friends and enjoying school.
	Body-kinesthetic intelligence helps your children to use their body in highly differentiated and skilled ways. Also develops working skillfully with objects, which involves the fine motor movements.
	Spatial intelligence helps your children to understand and remember the spatial relations among objects. It also develops remembering images, faces, fine details and visualizing objects from different angles.
	Intrapersonal intelligence helps your children develop good awareness of their own emotional states, feelings and motivations. It also helps them to know their own strengths and weaknesses to enhance them by time.
	Musical intelligence helps your children recognizes musical patterns and tones easily, remember songs and melodies. It can also develop rich understanding of musical structure, rhythm and notes.

Other Icons :

	Magnetic help your child to recognize and understand the value of numbers, develop thinking and problem solving.
	Age This symbol indicates the age for which this product is designed.
12085	Code are essential for developing different skills, as the child's benefit by his experiences will be limited without him being able to understand and express himself.
	New This symbol indicates that is a new product

Total Solution

We have the products you need, always when you need them! Our huge warehouse enables us to have products in stock, so you will not deal with shipping hassles.







Infants & Toddlers

From the very beginning of life, children's curiosity is insatiable. They want to see, touch, taste and explore everything around them. What better than providing them with the tools to guide them in a safe, enjoyable way? We at EDUFUN have the educational toys that are suitable to keep even the busiest of minds and hands satisfied as they explore their world and unconsciously developing their spatial, body-kinesthetic, linguistic, interpersonal Intelligence and much more.





+1 **NEW**

31311

Mini Building Blocks-Colored

Our Mini building blocks encourage creative play and healthy social interaction reinforcing the interpersonal intelligence. Toddlers will love to play with them because they are velvet-smooth and all edges are evenly curved. All the shapes are simple geometric shapes, large enough so that there is no danger if they by accident end up in your child's mouth. Patterns are added to the colored set to stimulate matching and comparing skills developing logical / mathematical intelligence.

Basic Block Module : 3.5 cm



+1 **NEW**

31310

Mini Building Blocks-Wooden

Our Mini building blocks encourage creative play and healthy social interaction reinforcing the interpersonal intelligence. Toddlers will love to play with them because they are velvet-smooth and all edges are evenly curved. All the shapes are simple geometric shapes, large enough so that there is no danger if they by accident end up in your child's mouth. It helps to stimulate matching and comparing skills developing logical / mathematical intelligence.

Basic Block Module : 3.5 cm



+2 **NEW**

41319

Medium Grape

These large brightly colored plastic grapes can be put together from all directions. Ideal for developing fine motor skills, color recognition, sorting and creativity which help enhance bodily/kinesthetic and spatial intelligence. Comes in 5 colors. Diameter 6 cm.



+1 NEW

88406

Construction Rabbits

These funny faced rabbits in 5 bright colors can be slotted together to create amazing constructions. Also young children can start building right away. Ideal for bodily/kinesthetic intelligence. Set of 50 pieces in plastic storage box.

Size of a rabbit: 8,3 cm

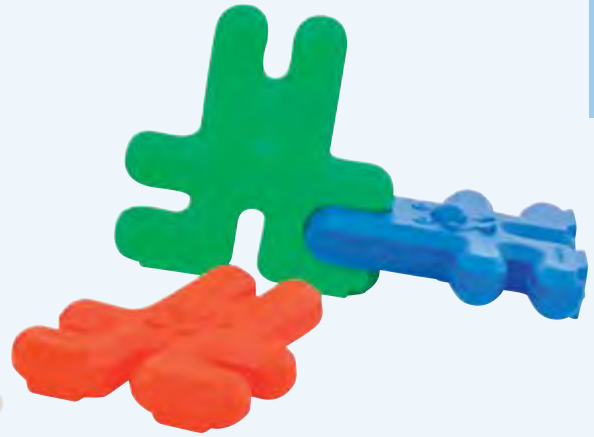

Jungle 31316

+2 NEW

building blocks

Perfect toy to allow your children to be creative and stimulate their imagination. While creating their own farm or Jungle and building animal figures, children develop bodily/kinesthetic intelligence. It also enhances logical / mathematical intelligence by developing the children's constructive and perceptive skills. Interpersonal intelligence is reinforced as children are encouraged to play together.

Basic Block Module : 3.5 cm



Farm 31317

+1

Screw heads

These wooden animals help strengthen a child's fine motors promoting bodily/kinesthetic intelligence. The child tries to fasten the head to the correct body colour to get the finished result of the animal. It is also possible to mix the bodies and heads to form new animals making it an entertaining toy for young children. Available in two shapes.

W 16 X H 6.5 X L 7.7 cm



A 13020

B 13025



+1 NEW

50158

Nuts & bolts activity set

This toy improves fine motor skills as well as teaching about colors shapes and numbers, leading bodily/kinesthetic and linguistic intelligence to be developed. Set includes 32 nuts & bolts and 12 durable plastic activity cards.

Card size 21cm X 24 cm.



+1 NEW

50160

Nuts & Bolts (64pcs)

These easy-to-hold, large size nuts & bolts are made from sturdy plastic, are durable for classroom use. Ideal for children to develop fine motor skills leading bodily/kinesthetic intelligence to be promoted comes in. 4 shapes and 4 colors.



Butter fly 13000

Tree 13005

+1

Nut & Bolts

A wooden toy for young children. Attractive picture to which the child puts the bolts into the different shapes then fastens them with nuts from behind to get the finished image. It improves hand/eye coordination and fine finger movement helping bodily/kinesthetic intelligence to be developed. Available in two forms (butterfly - tree).

W 25.7 X H 25 X L 4 cm



+2 **NEW**

The Wobbly Toy ▶

Teach your child to differentiate between the biggest and smallest size by building up our wobbly toy. Basic math, counting and size concepts are learned while playing developing logical/mathematical intelligence. It consists of a base with central rod, rings and a round ball.

W 8.2 X H 8.2 X L 15.5 cm



The wobbly Kid 21071



The wobbly man 21070

+2

31316

Funny Face Shapes

Children discriminate color, shapes and number concepts by stacking the funny face shapes correctly on the rods. Playing with this toy helps develop mathematical/ logical intelligence. Consists of wooden base with four rods and different shaped faces.

W 23X H 10X L 12 cm



+2 **NEW**

20040

Tower stacking rings ▶

11 Pieces (10 Colored rings + Wooden Base).The child places a number of rings according to the height of each rod and the number written in front of it. This toy Increases the ability of recognition, concentration and develops the skills of counting which enhances the logical/mathematical intelligence. It also improves fine motor skills leading bodily/kinesthetic intelligence to be developed.

W 20.2 X H 7X L 12.3 cm



+1

21046

Stacking rings Snail

Stacking game to place differently sized rings onto snail base in either large to small or small to large order stimulating logical/ mathematical intelligence. New words like bigger than / smaller than..etc. are learned while playing with this toy promoting Linguistic intelligence. It also Improves hand/eye co-ordination promoting bodily/kinesthetic intelligence.

W 14 X H 8.8X L 9.4 cm



+2 **NEW**

Playing with my...?

A set of interlock wooden puzzles that help the child's creative thinking and problem solving powers developing logical/mathematical intelligences. Each puzzle contains of 4 pieces making it easy for little ones. The set includes lovable animals to encourage children to talk and develop vocabulary helping to reinforce linguistic intelligences.

W 21.3 X H 21.3 X L 0.9 cm



Rabbit 11330



Parrot 11325



Sheep 11335



Bird 11300



Cat 11305



Golden fish 11315



Hen 11310



Turtle 11320

+2

10801

Junior 3D game

Is it possible to introduce the concept of three-dimensional for toddlers? Now we can! With this innovative and at the same time simple game. Children try to convert the two-dimensional pattern in to a three-dimensional model which helps develop logical /mathematical intelligence. Children are doing this in the form of a fun game and at the same time they learn an advanced engineering concept. 4 colorful characters, 6 wooden barriers in addition to the wooden base. 12 Patterns available.

W 18 X H 18 X L 4.8 cm



+1½

22085 ▶

Shape Sorting box

Helps the children to recognize shapes and colors. The children try to fit each shape into the matching space in the box which helps enhance logical/mathematical intelligence. It also Improves hand/eye co-ordination promoting bodily/kinesthetic intelligence. Ten different pieces representing shapes, animals and transportation enriching children's vocabulary and helping in developing Linguistic intelligence.

W 20.5 X H 12.8 X L 10 cm



+1

22071

▶ **Shapes small truck**

Sorting shapes into their corresponding slots teaches children the recognition of shapes and colors which help them develop logical/mathematical intelligence.

W 20.5 X H 12.8 X L 10 cm



+2 **NEW**

21165

Toddler grading shapes ▶

Children sort pegs by size, colour and shape (9 pegs in 3 basic rows). Builds up the child's fine muscle movements and how to differentiate between different sizes which help the logical/mathematical and bodily/kinesthetic intelligences to be improved.

W 14 X H 15.2 X L 6 cm



+2 **NEW**

39492

▶ **Geo Pegs and Peg Board**

36 stackable giant pegs in 6 bright colors, 3 shapes, with 21cm square base board and 3 laces. Ideal for promoting fine motor skills, counting, sorting and patterning leading to toward logical/mathematical and bodily/kinesthetic intelligence development. Pegs are with hole through the bottom, can be also used for lacing activities.



+1 **NEW**

Colored Cool Cars ▶

A creative twist in wooden cars that turn them into a real car! Five different shapes of wooden cars with acrylic windows which children will zoom happily across floors. Perfect for stimulating bodily/kines-
thetic and interpersonal intelligence.

W 9.4 x 8.1 x 4.1 cm



Train 22192



Van 22191



Car 22190



Truck 22194



School bus 22193



+1 **NEW**

22140 ▶

My Tiny Little Car

A fleet of five tiny wooden cars that children will never get bored from playing with them. These enduring cars are the perfect size for toddlers and stimulate bodily/kinesthetic and interpersonal intelligence.

W 7 X H 4 X L 4.6 cm



Crocodile 22196



Bunny 22197



Tiger 22195



Cow 22198



Puppy 22199

+1 **NEW**

▶ **Toddler Cute Animal Car**

Cute Animal Cars that open up limitless play scenarios for the imaginative child to create different worlds and adventures. These simple uncomplicated cars will zoom happily across floors offering children hours of fun, and parents great value for money. They are exactly the right size and shape for small hands to hold and push along. Perfect for stimulating bodily/kinesthetic and interpersonal intelligence.

W 7 X H 8.6 X L 4.8 cm



+2

Discover Who's bigger?

An enjoyable toy for a young child, consisting of 5 wooden boards. Each board has graded in size items from the biggest to the smallest. Builds up the child's fine muscle movements helping bodily/kinesthetic intelligence to be developed. It also helps children to differentiate between different sizes which lead to promoting logical/ mathematical intelligence.

W 30 x H 8 x L1 cm



Star 10524



Chick 10520



Ladybird 10521



Rabbit 10522

Frog 10523



+1

21111

Funny Circular Sorter

A large circular board with five circles varying in size from large to small. Your child can remove the circle with the easily manipulated knob. Improves the child's fine finger movement and hand-eye coordination helping bodily/kinesthetic intelligence to be improved.

W 25 x H 25 x L 2.9 cm



+1

21116

Funny shapes board

Children will discover the smiling faces when they remove the colorful geometrical shapes. Large knobs enable easy manipulation by small hands. Improves the child's fine finger movement and hand-eye coordination helping bodily/kinesthetic intelligence to be improved.

W 25 x H 25 x L 2.9 cm



+1

Surprise window

A delightful and attractive toy for children that will surprise them! Colourful shapes and picture appear as they lift the covers which encourage them to learn new words helping Linguistic intelligence to be promoted. Available in two themes (colors / shapes). Improves the child's fine finger movement and hand-eye coordination which enhances bodily/kinesthetic intelligence.



circles 10581



shapes 10576



+1

NEW

809

Touch & Feel pond

A wall chart printed in resistant plastic with six different textures for touching. It also includes suggestions of other activities that can be done with different age groups. Ideal for logical/ mathematical intelligence developing.



+2 **NEW**

Toddler Tracking board ▶

Fine motor skills are developed as Little children will move the knob to trace differently shaped lines following the directions of the arrows. A simple but important toy to develop pre-writing and motor-memory skills as a step in enhancing bodily/kines-
thetic intelligence.

W 30 X H 30 X L 2 cm

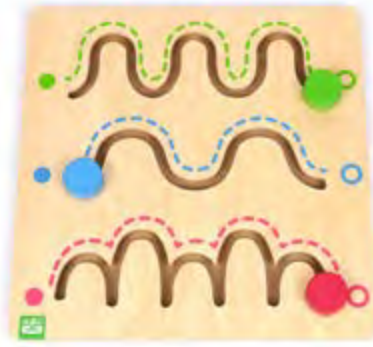

Level 1 21034



Level 2 21036



Level 3 21038



+2

937

▶ **Infant activity boards**

Four different hard plastic boards with four activities: touch, pre-writing, movement and visual/mirror. All 38x38cms with stickers included to fix anywhere. It is great for the development of fine motor skills helping bodily/kines-
thetic intelligence to be promoted.
W 38 x H 38 x L 0,3 cm.





Arts & Crafts

The world around us is full of color and shape. Help your child to appreciate his world and express his enjoyment in a creative way. Our arts and crafts products at EDU FUN aim to develop creativity, imagination, and a sense of color and shape which enhances the spatial intelligence, intrapersonal intelligence and interpersonal intelligence in children. It's easy when you have the right materials to promote multiple intelligence in any child.



Classroom Acrylic Paint ▶

Australian made Splash Classroom Acrylic Paint has been formulated for preschool and primary school students. A non-toxic, water-based paint made from quality ingredients ideal for use with younger children. This range consists of 14 dynamic colours in 5 litre paint bottles that when fitted with an Educational Colours paint pump are ideal for quick and efficient paint dispensing without any heavy lifting. The 2 litre paint is packaged in environmentally friendly PET bottles. This classroom acrylic paint is a favourite amongst teachers and students!



5 Litre - CS5



2 Litre - CS2



2 Litre - LT2

▶ Liquitemp Classroom Poster Paint

Australian made Liquitemp washable poster paint, is both water-based and non-toxic making it ideal for younger children to use safely. Made from the highest quality ingredients all colours have a rich and creamy texture with strong coverage. It brings both exceptional value and versatility to the classroom or home for children of any age. It can also be mixed with PVA glue to add more fun to crafting and sticking items. Great for all craft activities! Available in 31 colours including metallic and fluorescent. 5 litre paint bottles, when fitted with an Educational Colours paint pump, are ideal for quick and efficient paint dispensing without any heavy lifting. The 2 litre paint is packaged in environmentally friendly PET bottles.



500 ml Litre - LT500

LT500

Metallic Liquitemp Classroom Poster Paint ▶

Create striking artwork with these Australian made Metallic Liquitemp poster paints! Made from the highest quality ingredients, these paints have a rich, creamy texture and strong coverage. Liquitemp is non-toxic and water-based, ideal for younger children to use safely. Available in 9 popular metallic colours. These 500ml paints are packaged in environmentally friendly PET bottles.



Fluorescent Liquitemp Classroom Poster Paint

Create striking artwork with these Australian made Fluorescent Liquitemp poster paints! Made from the highest quality ingredients, these paints have a rich, creamy texture and strong coverage. Fluorescent Liquitemp is non-toxic and water-based, ideal for younger children to use safely. Available in 8 popular fluorescent colours. These 2 litre and 500ml paints are packaged in environmentally friendly PET bottles.



2 Litre - FLT2



500ml - FLT500

GLP500 Glitter Paint

Glitter Paint helps children create brilliant artworks that shimmer! Each bottle of vibrant coloured paint contains sparkling coloured glitter to add a dazzling effect to any craft project. Made from the highest quality ingredients, the glitter and paint are both the same colour for a highly saturated finish. This range consists of 11 dazzling colours, packaged in environmentally friendly PET bottles.



PLC500 Pearl Paint

Shimmering Pearl Paints are non-toxic, water-based and made from the highest quality ingredients. Perfect for creating luxurious artwork, children will love using these popular pearlescent colours. Fast drying and ideal for younger children. This range consists of 6 popular colours, packaged in environmentally friendly PET bottles.



WWC250

Washable Watercolor

Non-toxic, Washable Watercolours provide both brilliant colour and hours of creative fun to any classroom or home. With 14 dazzling colours available in environmentally friendly 250ml PET bottles, these paints will help you achieve that special watercolour effect!



FD500

Fun Dye

Non-toxic, Fun Dye is pre-mixed and ready to use! Fun Dye is ideal for use with paper, card, wood, wool etc. Same characteristics as powdered Fun Dye but no mixing is required. Simply add water or glue to vary the colour or consistency. While Educational Colours fun dye is made from food grade ingredients it is not packed under food grade conditions therefore it is not suitable for human consumption.



FP250

Finger Paint

Finger paint is perfect for early art experiences. Made from the highest quality ingredients, the thick and creamy texture reduces splashing and dripping. Children of all ages will enjoy a sensory experience creating artwork with their hands and feet. This range consists of 7 bright colours in 250ml pots.



MP100SET

Metallic Paint Set ▶

Australian made Metallic Paint by Educational Colours is nontoxic, washable and made from the highest quality ingredients. Create striking artwork with these rich and creamy poster paints, which provide a strong coverage. Non-toxic and waterbased, so ideal for younger children to use safely. This set of 4 x 100mL bottles of metallic red, metallic blue, metallic green and metallic purple.



GLP100SET

Glitter Paint Set ▶

Australian made Glitter Paint is non-toxic, washable and made from the highest quality ingredients, including plastic glitter not metal. Fantastic for adding a festive touch to collages, gift cards, mobiles and many other creative activities. This dazzling vibrant paint will add a new fun dimension to projects both in the home and the classroom. This set includes 4 x 100mL bottles of Glitter Paint; gold, red, blue and green. Children will love painting their masterpieces with this set!



FP100SET

Fluoro Rainbow Paint ▲

Australian made Fluorescent Paint by Educational Colours is a water-based junior acrylic paint that is known for its exceptional quality and versatility. A non-toxic fast drying paint that creates eye-catching paintings. This set includes 4 x 100mL bottles of fluoro pink, fluoro yellow, fluoro green and fluoro orange



PR100SET

Pearl Paint Set ▼

Shimmering Pearl Paint is nontoxic, water-based and made from the highest quality ingredients. Perfect for creating luxurious artwork, children will love using these popular pearlescent colours. Fast drying and ideal for younger children. This set includes 4 x 100mL bottles of Pearl Paint; pink, violet, yellow and green. Children will love painting their masterpieces with this set!



RP100SET

Rainbow Paint Set ▼

Rainbow Paint is a non-toxic, washable, junior acrylic paint that is known for its exceptional quality! Fast drying and made from quality ingredients, Rainbow Paint is ideal for younger children to use safely. Thick brilliant colours ensure this paint creates eye-catching artwork. Suitable for all craft activities. Includes 4 x 100mL bottles of Rainbow Paint in red, yellow, blue and green. Children will love painting their masterpieces with this set!



Face & body Paint

Educational Colours Face and Body Paint has been formulated by a cosmetic chemist because safety and quality are our highest priority! Made in Australia using the finest ingredients, these face paints are perfect for the most delicate little faces and bodies. Thick and brilliant colours mean only one coat is needed for full coverage. Removable with warm water and soap, no make up remover necessary. Available in 8 colours and in 175ml jars.



FACESET6



FACE175



Face and Body Crayons

An exciting alternative to traditional face paint. Easy to use, non toxic and dermatologically tested, these crayons are perfect for young children. Their silky soft texture creates smooth, bright, bold colours. Ideal for face painting on special occasions such as parties, sports events and concerts – in fact anytime! Suitable for all skin types, these premium crayons are odourless, do not make hands dirty, and are easy to wash off with soap.



FBC3



FBC6



TW4

Texture Wands Set 1 ▶

A unique, fun, 'paint brush' alternative to add interest and new textures to young students work. These chunky brush wands were designed for little hands to hold. Introduce new ways to create first masterpieces, with the 4 different textures - foam strips, rough sponge, soft foam and chamois. Wands measure 15cm long.



TW42

Texture Wands Set 2

A unique, fun, 'paint brush' alternative to add interest and new textures to young students work. These chunky brush wands were designed for little hands to hold. Introduce new ways to create first masterpieces, with the 4 different textures - foam zigzag strips, foam noodle strips, chamois strips and sponge strips. Wands measure 15cm long.



PP12

Paint Pipettes

3ml pipettes, ideal for use with watercolours, food dyes and thinned Liquitemp or Educational Colours acrylic paints. Pipettes measure 15.8cm long x 1.2cm diameter at the bulb x 0.3cm diameter at the tip. Pack of 12.



PP6

Giant Bulb Pipettes ▲

Perfect for use with watercolours, dyes and inks, the use of a pipette helps to build fine motor skills (needed for cutting and writing) and develop hand-eye coordination and cognitive development. The child's grip on the bulb of the pipette trains children to use the three fingers grip that is used to hold and control a pencil. Measuring 23cm long. Each Giant Pipette has a volume of approximately 45ml. Pack of 6.



PSP

Paint Stamper Pads

Educational Colours non-toxic, jumbo washable Paint Pads are ideal for young children to explore painting with their hands and feet. They can also create their masterpieces with Educational Colours Paint Stampers by simply pressing firmly into the paint pad and then transferring the stamper to paper or any variety of surfaces. Each pad has a replaceable lid to prevent the paint from drying out between uses. These jumbo paint pads measure 160mm in diameter and come in 9 vibrant colours.



Paint & Dough Stampers

Educational Colours Paint and Dough stampers are made of robust plastic and ideally suited to small hands for both classroom and home use. Measuring 80mm high and with a stamp diameter of 60mm they are ideal for general art activities and theme projects. Strong, plastic moulded, hangsell packaging.



PSTTT6 Transport



PSTN10 Numbers



PSTS6 Sea



PSTG10 Geometric



PSTJ6 Jungle

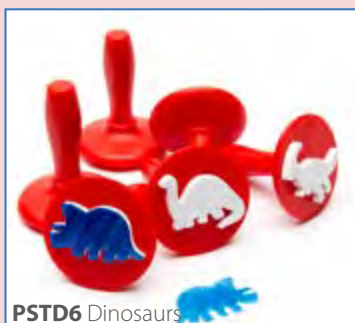

PSTD6 Dinosaurs



PSTFA6 Farm

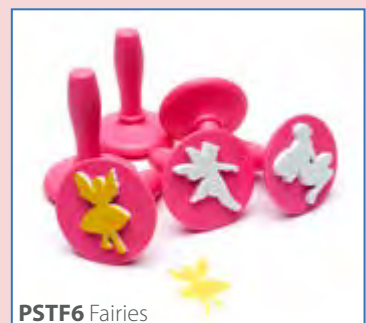

PSTF6 Fairies

ECFBS60 ▼

Hog Hair Brushes Flat

Educational Colours Series 579 brush set has a medium lacquered wooden handle and flat genuine hog hair bristles. This cost effective set is perfect for all classrooms. 10 each of sizes 4, 6, 8, 9, 10 and 12.



▲ ECBS60

Hog Hair Brushes Round

Educational Colours Series 582 brush has a medium lacquered wooden handle and round genuine hog hair bristles. This cost effective set is perfect for all classrooms with a variety of brush sizes. 10 each of sizes 4, 6, 8, 9, 10 and 12.



BMBRP30 ▶

Jumbo Stubby Brush

Economical Educational Colours round stubby brushes are ideal for all artwork. They have long plastic handles, ideal for children's hands to grip. Made from genuine hog bristle that is easy to clean. Tub contains 30 different coloured brushes, each 19.5cm long.



BJRWB4

▼ Jumbo Stubby Brush Set

This most popular Educational Colours brush is ideal for all artwork. This round stubby brush has a thick handle, ideal for children's hands to grip. Made from genuine hog bristle which is easy to clean. Brushes measure 19.5cm long. Set of 4 round brushes in red, green, yellow and blue.



BMMM

Brush Set ▲

This set of Educational Colours brushes is perfect for an older child and ideal for all artwork. Brushes have medium wooden handles and round genuine hog bristle that is easy to clean. Set of 3 different size round brushes



▶ BABYS24

Baby Stubby Brush

This is the first brush any child should have! The size and weight are ideal for those little creative hands. Assorted colours, 100mm long.



BJS

▲ Junior Brush Set

This is a great starter set of brushes for young children. Easy to clean and extra durable. This set contains 3 different size brushes.



SPPSS

Paint Pot Stand Set ▶

Ideal for classroom or home use. 6 Premium Paint Pots cleverly designed to prevent spillage even when knocked over. Each pot measures 9cm high with a 21cm diameter. A durable plastic stand which measures 57.2cm L x 15.5cm W is included



▶ **SPPS6S**

Premium Safety Paint Pot

These Educational Colours Premium Paint Pots are cleverly designed to prevent spillage, even when the pot is knocked over. The lid has 2 grooves to rest brushes on, keeping them off the table or easel. Pots can be filled with either water or paint. Each pot measures 9cm high with a 21cm diameter. 1 red, blue, yellow, green, black and white, plus 6 stoppers.



▶ **WP5**

Water Pot

Educational Colours white Water Pot is designed with an extra wide base for stability. Size: 9.5(H) x 10.5cm(D).



SPPBP

Premium Safety Paint Pot ▲

Set of 3 premium paint pots and stoppers.

P8**6 Well Muffin Palette** ▶

A 6-well plastic 'muffin'-style palette measuring 275mm x 180mm.

**P10****9 Well Muffin Palette**

A 9-well muffin-shaped plastic palette measuring 275mm square.

**Junior Artist Smock** ▶

Junior Artist Smocks will keep little artists clean when they are painting their masterpieces! Made from wipe-clean protective material, for messy play, where ordinary aprons just won't do! Elasticised soft cotton collar and cuffs are gentle on skin. Open back ventilation and loose fitting flexible design with a velcro backing. Size suits average 5-8 year old. Available in bright colours. The Junior Smocks are 70cm in length from the highest point of the collar and the sleeve is 32cm in length from the underarm joint to the end of the cuff.



JASGB Junior Artist Smock Green and Blue (ages 5-8)

JASP Junior Artist Smock Purple (ages 5-8)

Craft PVA Glue ▶

This Australian made craft PVA is non-toxic, washable, acid-free and pH neutral – unlike many other PVAs on the market. This superior quality PVA adheres well to a wide range of products including paper, cardboard, wool, wood and textiles. Suitable for all craft activities as it dries clear, smooth and quickly



PVA2 Craft PVA Glue 2 Litre



PVA1 Craft PVA Glue 1 Litre



PVA250 Craft PVA Glue 250ml



KP2 Kids Washable PVA 2 Litre



KP1 Kids Washable PVA 1 Litre



KP250 Kids Washable PVA 250ml

◀ **Kids Washable PVA**

This Australian made Kids PVA is non-toxic, non-staining, washable, acid-free and pH neutral – unlike many other PVAs on the market. Suitable for all craft activities as it dries clear, smooth and quickly. It washes easily from clothes and hands.

Craft Clear Gum ▶

Australian made, non-toxic, Educational Colours Clear Gum, is perfect for a wide range of art and craft activities. It adheres to most surfaces including paper, cardboard, textiles and more. Drying clear means you won't see it on the final artwork. Non-toxic, non-staining and washable makes this adhesive suitable for all ages. Available in 5 Litre bottles for education, then environmentally friendly 500ml and 250ml PET bottles.



RP5 5 Litre Ready Paste



RP500 500ml Ready Paste



GUM500 Clear Gum 500ml



GUM250 Clear Gum 250ml

◀ **Ready Paste**

Australian-made, non-toxic Ready Paste is suitable for a variety of uses in schools and offices. It adheres to numerous surfaces including paper and cardboard. Being non-toxic and washable makes it ideal for young children.



Jumbo Oil Pastels ▶

Educational Colours Oil Pastels are of superior quality, non-toxic and richly colour-pigmented. Everyone will love the brilliant effects from using and blending these oil pastels. Pastels are round and individually wrapped in a matching colour paper sleeve for easy identification when out of the packet and/or worn down. Suitable for artists of all ages.



OPJ... Jumbo Oil Pastels 24 pieces

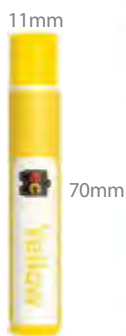

OPJ432 Jumbo Oil Pastels Classroom Set 432 pieces



OPJ... Jumbo Oil Pastels 12 pieces



OPFJ12 Jumbo Fluorescent Oil Pastels Pack of 12



OPMJ12 Jumbo Metallic Oil Pastels Pack of 12

JC200

Jumbo Crayons School - Box of 200 ▼

Little hands will love this range of non-toxic classroom Crayons. There are enough Crayons in this partitioned and reinforced storage box for a whole year. Contains 25 each of 8 colours, 115mm x 13mm.



RC800

Best Value' Crayons - Box of 800 ▼

Enough Crayons for the classroom for the whole year. This non-toxic, economical range comes in a partitioned reinforced storage box. Contains 100 each of 8 colours. 90mm x 8mm.



Twist It Crayons

Educational Colours Twist-It Crayons are non-toxic, washable and make drawing fun and messfree! Easily twist the crayon up and down to control how much you are working with. The clear barrel allows you to see how much crayon is left to use. Each crayon measures 146mm x 5.8mm. 12 bright colours in the pack of 12. 16 bright colours in the box of 244.



TIC12 Twist-It Crayons Packet of 12



TIC240 Twist-It Crayons Box of 240



MM12 Master Markers Packet of 12

Master Markers

Educational Colours Master Markers lay down bright and radiant colours! Our washable markers are child safe with non-toxic, water-based ink and child safe ventilation caps. Each marker has a durable, fine, 2.6mm sink-resistant nib making them perfect for drawing detailed images. 12 vibrant colours in the range. Perfect for the young aspiring artist to express their imagination!



MM96 Master Markers Tub of 96



MM144 Master Markers Crate of 144



MMMT48 Master Mega Markers Tub of 48



MMMB288 Master Mega Markers Box of 288



Master Mega Markers

Educational Colours Master Mega Markers are perfect for young artists featuring jumbo barrels that are easy to hold. Our washable Master Mega Markers are safe for children with non-toxic, water-based ink and child safe ventilation caps. Our markers feature broad tapered tips for both bold strokes or fine lines. The Master Mega Markers feature 5.8mm sink-resistant nibs that are engineered to sustain heavy pressure when colouring. 12 vibrant colours in the range. Perfect for the young aspiring artist to express their imagination!



MMMP12 Master Mega Markers Packet of 12



MMMC96 Master Mega Markers Crate of 96



SAU

Alphabet Upper Case Stencil ▶

These durable thick plastic stencils can be easily cleaned, with soap and water after being used with paint, markers, chalk, pastels etc. All stencils include both the positive and negative of the stencil, therefore 2 of each letter. Stencils can be used in a variety of different projects. Set of 26 measures 75mm x 45mm.

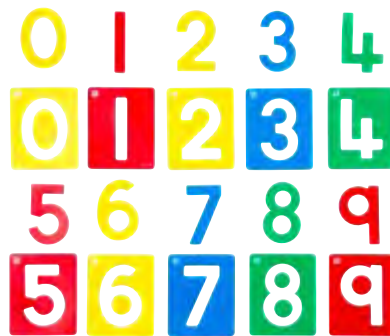

SNS10

Numbers small Stencil

These durable thick plastic stencils can be easily cleaned with soap and water after being used with paint, markers, chalk, pastels etc. All stencils include both the positive and negative of the stencil, therefore 2 of each number. Stencils can be used in a variety of different projects. Set of 10 measures 90mm x 110mm and includes numbers 0-9.

ST61

Transport Stencils ▶

These large and durable thick plastic stencils can be easily cleaned with soap and water after being used with paint, markers, chalk, pastels etc. All sets of stencils include both the positive and negative of the stencil, therefore 2 of each mode of transport. Stencils can be used in a variety of different art projects. Set of 6 measures 200mm x 200mm and includes a Car, Truck, Boat, Helicopter, Train and Aeroplane.



SS61

Sea Life Stencils

These large and durable thick plastic stencils can be easily cleaned with soap and water after being used with paint, markers, chalk, pastels etc. All sets of stencils include both the positive and negative of the stencil, therefore 2 of each animal. Stencils can be used in a variety of different art projects. Set of 6 measures 190mm x 190mm and includes a Dolphin, Crab, Shark, Whale, Octopus and Penguin.



Fun Dough ▶

Educational Colours Fun Dough is safe, non-toxic and washable, making it ideal for young children and early model making. Bright colours make it appealing for children to create fun artwork using their hands and dough tools. Playing with dough is a sensory experience and also helps children develop hand to eye coordination and fine motor skills, making this a great activity for the classroom and home. Large, re-usable tubs for easy storage and available in 6 colours!



FD12YL Yellow 1.2kg tub



FD12OR Orange 1.2kg tub



FD12RD Red 1.2kg tub

FD12ASS Fun Dough Assorted 1.2kg tub



FD12GR Green 1.2kg tub



FD12PUR Purple 1.2kg tub



FD12BL Blue 1.2kg tub



COT1

◀ **Cream of Tartar**

Cream of Tartar is ideal for making your own Fun Dough!

Modeling foam

Modeling foam is a soft, lightweight, air hardening modeling material. While being extremely soft and pliable, modeling foam offers unique texture and look. Modeling foam is a great choice for arts and crafts projects.



072628



072012



072557



072526



072555



072558

Super dough ▶

Innovative dough that offers a clean, safe, and imaginative opportunity for children to play. An air-hardening modeling material, light-weight, smooth, soft to the touch, and is extremely pliable.



081223

081394



081172



081169



081168



Sandy clay ▶

Playing with Sandy Clay is really fun and helps children to be creative. It is Mess-Free sand and will only stick to itself. A very great indoor activity that will guarantee hours of fun.



140032-33-34



140057



140037

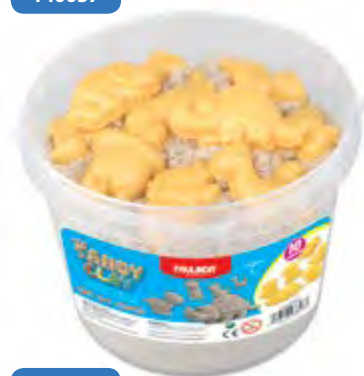

140039

PRA2

Palm Texture Rollers ▶

These palm rollers have been specifically designed for young hands! Perfect for children to grip and roll through paint or dough adding interesting patterns and textures to their creations. Features 2 assorted designs, which are easy to clean.



RRP4

Rubber Patterned Rolling ▼

A set of patterned rolling pins, which are suitable for dough or paint. Set of 4. Rolling pins measure 17.6cm x 4cm in diameter.



APRS4

Animal Pattern Rocker Stampers

These Educational Colours Easi-Grip Animal Pattern Stampers will keep children entertained for hours and encourage creative pattern activity. Made from soft rubber with big chunky handles they are ideal for young children's hands to grip. Stamp animal prints and fun designs using paint, clay, dough, coloured sand or stamp pads. Set of 4 different animal patterns: snakeskin, leopard print, stripes and scales. Easy to clean, the stampers measure 7.5cm x 5.5cm.



HPS4

Hemispherical Pattern Stampers ▼

Educational Colours Easi-Grip Hemispherical Pattern Stampers will keep children entertained for hours and encourage creative pattern activity. Made from soft rubber with big chunky handles they are ideal for young children's hands to grip. Stamp prints and fun designs using paint, clay, dough, coloured sand or stamp pads. Set of 4 different patterns, these easy to clean stampers measure 7.5cm x 5.5cm



EGPRS

Easi-Grip 4 in 1 Pattern Roller ▶

Educational Colours Easi-Grip 4 in 1 Pattern Roller is an interchangeable rolling pin that includes two handles and 6 different screw-together, patterned/plain pieces to create an endless variety of designs! Children will have fun pulling apart and remaking the roller with their desired patterns. The rolling pin can be used with paint, paint stamper pads and dough. Easy to clean, the roller measures 20cm long.



DM

Dough-It' Extrusion Machine ▼

This exciting easy-to-use extruder lets young children produce 12 different patterns to decorate their dough project. Measures 14.6cm x 4.3cm x 6.9cm high.



DE4

Dough Extruder

These sturdy plastic dough extruders are a great modelling accessory and will provide hours of creative play. They will extrude dough in different shapes including spaghetti, squares, big circles and a flower shape. Set of 4.



CCGB4

Giant Garden Bug Dough Cutters ▶

Colourful 'cookie'-style cutters that are great for dough, plasticine and clay. Make wonderful cut outs with these varieties. Set of 4 giant garden bugs including a snail, butterfly, spider and labybird. Hangsell packaging
Size : 12 x 12 x 10 cm



CCF6

▼ **Fruit Dough Cutters**

Colourful 'cookie'-style cutters that are great for dough, plasticine and clay. Make wonderful cut outs with these varieties. Hangsell packaging.



CCJ6

Jungle Animal Dough Cutters ▲

Colourful 'cookie'-style cutters that are great for dough, plasticine and clay. Make wonderful cut outs with these varieties. Set of 6 jungle animals including a elephant, crocodile, giraffe, lion, hippo and parrot.



▼ **FD5**

Fun Dough Accessories

A great retail set of 5 assorted dough accessories. Made of durable plastic and packaged in a hang sell. Can be used with dough or clay and will keep kids entertained for hours!



DP52

Dough Characters ▶

Children can use their imagination to mould and shape their own creatures! Set of 52 pieces includes feet, shoes, arms, claws, lips, noses, eyes, mouths and hats.



Air Drying Clay Terracotta ▼

Educational Colours Air Drying Clay is ready to use. This modelling material can be used to create various objects such as jewellery, ornaments and figurines. No baking is required, object will set hard when left to dry in open air. Drying time varies according to thickness and climatic conditions. The use of wet hands or wet brush whilst shaping will assist in creating smooth texture. Objects can be painted and varnished once dry. Ensure unused Educational Colours Air Drying Clay is resealed airtight in the package to retain malleable consistency.



ADCW500 Air Drying Clay White 500 grams



ADCT1 Air Drying Clay Terracotta 1kg



ADCW1 Air Drying Clay White 1kg



ADCT500 Air Drying Clay Terracotta 500 grams



Air drying clay white ▲

Educational Colours Air Drying Clay is ready to use. This modelling material can be used to create various objects such as jewellery, ornaments and figurines. No baking is required, object will set hard when left to dry in open air. Drying time varies according to thickness and climatic conditions. The use of wet hands or a wet brush whilst shaping will assist in creating a smooth texture. Objects can be painted and varnished once dry. Ensure unused Educational Colours Air Drying Clay is resealed airtight in the package to retain malleable consistency.



◀ SFGV50 Water Based Gloss Varnish 50ml





AMS600

Adhesive Mouths ▶

Easy to use mouth stickers on a roll. 6 assorted design: measuring approximately 15mm. Perfect for adding character to craft projects. Roll of 600.



Adhesive Noses ▲

Easy to use nose stickers on a roll. 6 assorted designs measuring approximately 15mm. Perfect for adding character to craft projects. Roll of 600.



AEBW2000

Adhesive Black & White Eyes ▲

Roll of 2000 pairs of styled black and white eyes with 6 different characteristics from 'sleepy' to 'pop eye'. Each adhesive eye has a 1.4cm diameter



AEC2000

Adhesive Coloured Eyes ▲

Roll of 2000 pairs of styled coloured eyes with 10 different colours and characteristics from 'sleepy' to 'pop eye'. Each adhesive eye has a 1.4cm diameter



CSB6100

Chenille Stems – Black ▲

Ideal for making silhouettes, figurines and animal shapes. High-quality black chenille stems, measuring 300mm x 6mm. Packet of 100.



CSP6100

Chenille Stems – Pastel Colours ▲

Inspire childrens' imagination with these high-quality pastelcoloured chenille stems which are perfect for any craft activity. Cut them, twist them, bend them, link them; the uses are endless! Packet of 100 stems, measuring 300mm x 6mm, in 5 pastel colours.



CSN6100

Chenille Stems – Neon Colours ▲

Inspire childrens' imagination with these high-quality neon-coloured chenille stems which are perfect for any craft activity. Cut them, twist them, bend them, link them; the uses are endless! Packet of 100 stems, measuring 300mm x 6mm, in 4 neon colours.



CS6100

Chenille Stems – Standard Colours ▲

Inspire childrens' imagination with these high-quality chenille stems which are perfect for any craft activity. Cut them, twist them, bend them, link them; the uses are endless! Packet of 100 stems, measuring 300mm x 6mm, in 10 bright colours.





PPNA50

Pom Poms Neon Colours ▲

Pom Poms are fun for lots of crafty things, making colourful caterpillars or just playing with them. These bright neon fluffy pom poms will add a 3D effect to any craft activity. Assorted neon colours and sizes in a bag of 50.



PPGA200

Pom Poms Glitter Colours ▲

Pom Poms are fun for lots of crafty things, making Christmas stockings or just playing with them. These sparkly and fluffy pom poms will add a 3D effect to any craft activity. Assorted colours and sizes in a bag of 200.

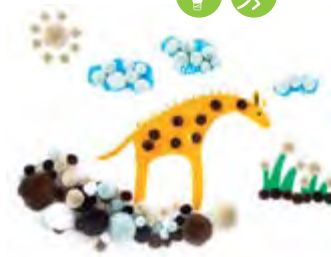

PPPA150

Pom Poms Standard Colours ►

Pom Poms are fun for lots of crafty things, making friendly lions or just playing with them. These bright and fluffy pom poms will add a 3D effect to any craft activity. Assorted colours and sizes.



PPAA300

Pom Poms Animal Colours ▲

Pom Poms are fun for lots of crafty things, making jungle animals or just playing with them. These bright and fluffy pom poms will add a 3D effect to any craft activity. Assorted animal colours and sizes in a bag of 300.



Super beads ►

A totally new and different beads game. Children will enjoy creating a various designs with beads for a lot of hours. No ironing needed, just water is needed.





Educational Toys

The early Pre-school years before formal education are the most formative for children. Their little minds are wide open and ready to accept any knowledge and information that they are subjected to. EDU FUN believes that enhancing and advancing children's multiple Intelligence during these crucial years is essential to build up a strong foundation for a life-time of learning success. EDU FUN has designed products for both pre-school and older children to help them explore and discover their world.







+1

41316

◀ Groovy Animals

Let your children have fun with this cute and colorful set of assorted rubberized animals, which have been designed with tongue and groove connectors. Great for developing fine motor skills, color recognition, sorting and creativity which help enhance bodily/kinesthetic and spatial intelligence.

Height: 6,5 cm



+3

12134C

◀ Linking Cube Set

This set includes 500 blocks in 10 bright colors, comprising 400 cubes, 50 triangles, 50 quadrants, 4 base boards and 42 2-sided activity cards in sturdy storage container. Cube measures 2cm square. Helps promote logical/ mathematical intelligence and encourage creativity and Innovation.

Cube: 2 cm Square



Wooden 31312

+2 **NEW**

◀ Basic Building Blocks

Our Mini building blocks encourage creative play and healthy social interaction reinforcing the interpersonal intelligence. Toddlers will love to play with them because they are velvet-smooth and all edges are evenly curved. All the shapes are simple geometric shapes, large enough so that there is no danger if they by accident end up in your child's mouth. Patterns are added to the colored set to stimulate matching and comparing skills developing logical / mathematical intelligence.

Basic Block Module : 3.5 cm



Colored 31313

+2 NEW

Large building blocks ▶

Perfect toy to allow your children to be creative and stimulate their imagination. While creating their own farm and building farm animal figures, children develop bodily/kinesthetic intelligence. It also enhances logical / mathematical intelligence by developing the children's constructive and perceptive skills. Interpersonal intelligence is reinforced as children are encouraged to play together. Made of high quality natural wood with non-toxic paints conforming to European toy safety standards.

Basic Block Module : 3.5 cm



Wooden 31314



Colored 31315



+3 NEW

31330

◀ **Mirror Window Blocks**

Blocks with a new twist which attract children as they use the mirror reflects in endless play. 16 wooden blocks with mirror insert. These blocks are the same module as our blocks sets. Creativity and imagination is developed through new ways of thinking and therefore logical/ mathematical intelligence is promoted. Also social intelligence is built through team work, and language and communication skills are improved developing linguistic intelligence.

Basic Block Module : 3.5 cm



+3 NEW

31325

Colored Window Blocks ▶

Delightful coloured blocks that are the same module as our blocks sets. Set of 24 see through coloured acrylic wooden blocks. These types of open ended toys promote exploratory and investigative play. Creativity and imagination is developed through new ways of thinking and therefore logical/ mathematical intelligence is promoted. Also social intelligence is built through team work, and language and communication skills are improved developing linguistic intelligence. Made of high quality natural wood with non-toxic paints conforming to European toy safety standards.

Basic Block Module : 3.5 cm





+3

31390

Colored Big Blocks

Beautiful building blocks made from natural beech wood. All blocks are well finished in a multitude of different shapes and sizes. These blocks will stand years of hard use. The unit block system makes it easy for children to understand size relations and develop skills through block play promoting logical / mathematical intelligence. Cooperative play is developed and children will amaze themselves with their imaginative construction which will enhance their interpersonal intelligence.

W 38.1 x H 35.7 x L 30.8 cm



No.	Shape	Quantity	Size
1		18	35 x 35 x 35 mm
2		16	7 x 35 x 35 mm
3		8	105 x 35 x 35 mm
4		2	175 x 35 x 35 mm
5		24	35 x 35 x 17.5 mm
6		4	70 x 35 x 17.5 mm
7		18	105 x 35 x 17.5 mm
8		10	210 x 35 x 8.75 mm
9		8	70 x 70 x 35 mm
10		8	105 x 35 x 35 mm
11		14	7 x 35 x 35 mm
12		20	35 x 35 x 17.5 mm
13		9	70 x 35 Rmm
14		6	35 x 35 Rmm
15		11	70 x 35 x 35 mm
16		11	525 x 35 x 17.5 mm
17		1	140 x 70 x 35 mm
18		1	70 x 35 x 35 mm
19		4	70 x 35 x 35 mm
Total Quantity		193	

* This Flexi storage unit can accommodate our Natural big blocks for organized, space saving and mobile storage. Code **64045**



+3

31385

Natural Big Blocks

Multi shaped wooden blocks which are designed to explore basic math and science problems. Logical / mathematical intelligence is developed by enhancing the child's constructive and perceptive skills. These blocks are made of solid beech wood and can be stored in a compatible wooden storage unit to save space and keep them organized.

W 70 x H 100 x L 40 cm



No.	Shape	Quantity	Size
1		30	70 x 70 x 35 mm
2		27	140 x 70 x 35 mm
3		9	280 x 70 x 35 mm
4		9	280 x 70 x 11 mm
5		12	140 x 35 x 35 mm
6		6	140 x 70 x 35 mm
7		6	70 x 70 x 35 mm
8		36	70 x 70 x 35 mm
9		3	140 x 70 x 35 mm
10		3	70 x 35 x 35 mm
11		6	140 x 70 x 35 mm
12		6	140 x 70 x 35 mm
13		3	280 x 210 x 35 mm
14		3	180 x 70 x 35 mm
15		12	140 x 350 mm
16		6	140 x 70 x 35 mm
17		6	70 x 70 x 35 mm
Total Quantity		183	



Hollow Blocks ▶

Children can build, design and create amazing structures with these open sided blocks. These blocks offer hours of creative play, problem solving and mathematical reasoning enhancing logical/mathematical intelligences. Standard unit-block constructed with soft edges and smooth surfaces. A great, robust resource for child-initiated and collaborative play encouraging social intelligence. Bodily/kinesthetic intelligence is strengthened as children use their muscles to transport and build.

Available in two sizes :

Large Hollow Blocks

Mini Hollow Blocks

Basic Block Module : 14 cm



Large Hollow Blocks		
Shapes	Quantity	Size
	4	56 x 14 x 1.2 cm
	2	112 x 14 x 1.2 cm
	2	28 x 14 x 14 cm
	5	28 x 28 x 14 cm
	2	56 x 28 x 14 cm
	2	56 x 28 x 14 cm
Total	17	



+5 Large Hollow Blocks 31320

* This Combi storage unit can accommodate our Large Hollow Blocks for organized, space saving and mobile storage.
Code **45520**



+3 Mini Hollow Blocks 31322



Mini Hollow Blocks		
Shapes	Quantity	Size
	10	14 x 14 x 7 cm
	6	28 x 14 x 7 cm
	4	56 x 14 x 7 cm
	4	28 x 14 x 7 cm
Total	24	

+3

13208C

◀ Rainbow Pebbles

Children will have much fun with this construction and early mathematics manipulative. Ideal for developing fine motor skills, and for counting, sorting and creative design. As a result logical/ mathematical and bodily/kinesthetic intelligence is enhanced. Set includes 36 pebbles in 6 sizes and 6 colors, and 20 activity cards in a sturdy plastic container.



+3

41303

Large mosaic ▶

This large grid mosaic puzzle board will help the children to develop their creativity while offering hours and hours of fun. They can use their own imagination or the sample images included with the game. Exciting and educational, this game would make a development in the bodily/kinesthetic and spatial intelligence, in addition to a neat occupation for any child from the age of 3.



+4

31220

◀ Colour Mosaic

Wooden mosaic pieces provide the child with the opportunity to develop his sense of invention and creativity. Consists of multi coloured wooden shapes of various sizes to enable the child to construct different shapes. Plays an important part in developing the child's sense of classification which enhances the logical/ mathematical and spatial intelligences. Comes with a variety of patterns.



+4

31205

Shapes Mosaic ▶

The child can form many artistic patterns from these attractively colored pieces of mosaic, giving the opportunity of critical thinking and problem solving which enhances the logical/ mathematical intelligence.. Helps also to differentiate between shapes and colors which help enhancing spatial intelligences. It also develops his power of imagination. Comes with patterns. W 28 x H 28 x L 1.9 cm

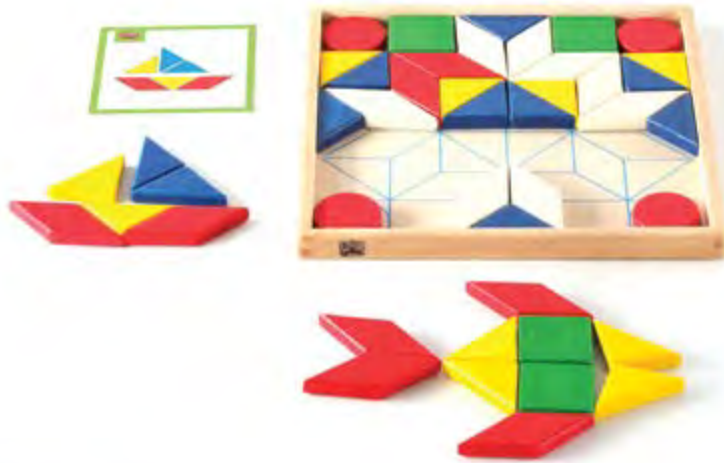

Educational
Toys

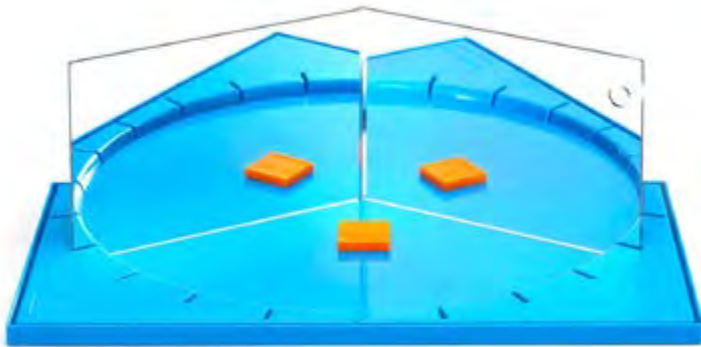

+5

22242

Geoland

Geoland is an ideal STEM product as it links science and mathematics, which leads to develop logical/ mathematical and Spatial intelligences. Students may explore the geometry of symmetry and reflection, and the science of light and reflections. Examine the number of images reflected from an object by changing the angle of the mirrors. Set includes 3 vertical acrylic mirrors, one semicircular horizontal acrylic mirror, plastic frame with degree graduations, 30 pattern blocks. Number of images observed in the mirrors equals 360 degrees divided by the angle between the two mirrors.

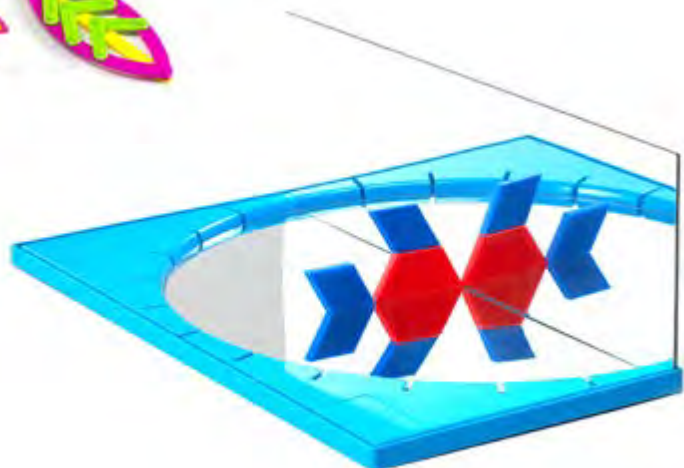
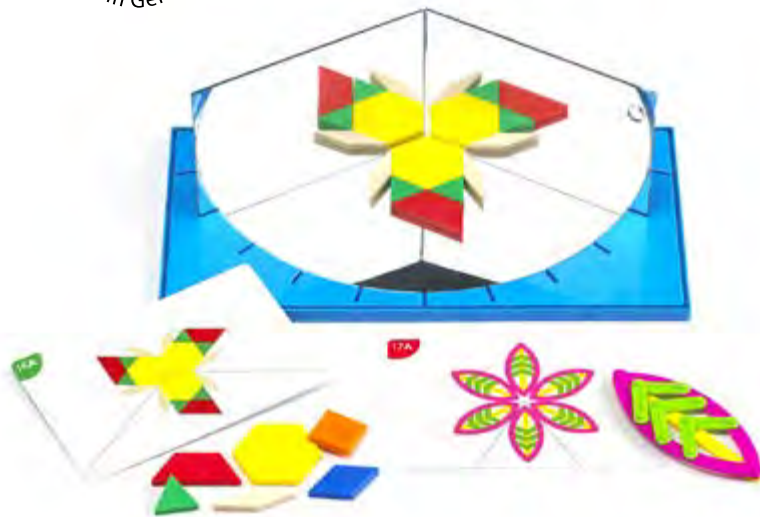



+3

418

Tris Tris

A great threading and manipulative game for uniting logical concepts such as colors, sizes, shapes, numbers and expressions. It is great for the development of fine motor skills helping bodily/kinesthetic and logical/mathematical intelligences to be promoted.



+4

50550

Mixed Colorful Set of Beads

650 beads mixed in color. 6 strings are also added. Sorting, sequencing, counting and visual memory skills are developed helping logical/mathematical and bodily/kinesthetic intelligences to be promoted.



+3

50538

Lacing Hands

72 lacing hands made of plastic and 6 laces in a transparent box. Not only for the development of fine motor skills, but also for making addition and subtraction exercises. Great for bodily/kinesthetic and logical/mathematical intelligence development.



+1

13820 C

Small Buttons

Bright buttons in 12 shapes and 10 colors. Shapes include bear, circle, cloud, face, flower, heart, octagon, rectangle, ribbon, square, star and triangle. Set of approximately 400pcs in sturdy plastic container. Great for training color recognition and sorting skills which develop logical/mathematical intelligence. Also great for the development of fine motor skills helping bodily/kinesthetic intelligence to be promoted.



+4

42020

Lacing Wild animals

Our various lacing animals are made from solid plastic with large threading holes. Ideal for developing hand-eye co-ordination helping bodily/kinesthetic intelligence to be promoted. Hippopotamus, monkey, rhinoceros, giraffe, elephant and lion. 3 colors, 6pcs, 18 laces.



+4

42010

Lacing animals

Our various lacing animals are made from solid plastic with large threading holes. Ideal for developing hand-eye co-ordination helping bodily/kinesthetic intelligence to be promoted. Bear, dog and duck, 3 colors, 9pcs, 27 laces.



+4

41249

Threading Animals

Enhance eye-hand coordination with this huge set of threading animals. Children learn to focus on the task at hand and will improve their fine motor skills at the same time helping bodily/kinesthetic and spatial intelligence to be promoted. 32 lacing shapes, 16 laces, 90 cm



+4

35681

Lacing Animals

9 lacing animals (3 bears, 3 ducks and 3 dogs) and laces in 3 different colors. Great for training color recognition and sorting skills which develop logical/ mathematical intelligence. Also great for the development of fine motor skills helping bodily/kinesthetic intelligence to be promoted. Can also be used as templates.





+4

483

▶ Tie me up! Giant Shoe

Learning how to tie your laces has never been so easy. It is great for the development of fine motor skills helping bodily/kinesthetic intelligence to be promoted. The giant size and having it handy on the wall made it easier to practice!

It has an adhesive textile on the back for wall fixing. Size: 25,5x49 cm.



+4

887

▶ Small Shoes

A great way to learn how to tie your laces, make bows, etc.

Their small sizes make it easy for children to hold in their hands. It is great for the development of fine motor skills helping bodily/kinesthetic intelligence to be promoted.



+4

815

▶ Lace the shapes

12 different shapes for learning, threading, tracing and dot-to-dot activities. A perfect educational aid for the development of fine motor skills helping bodily/kinesthetic intelligence to be promoted.

Shapes size: 16x16cm aprox.



+4

740

▶ Clothes for threading

Small practical plastic cards for threading contours of clothes and learning to tie your shoes.

Contents: dress, trousers, shoe, skirt, glove, sock, jumper, shorts, cap and T-shirt + laces. Ideal for bodily/kinesthetic intelligence development.

size: 16,5x11 cm.



+3½ **NEW**

21025

Follow the fish ▶

As the fish is moved along the various paths, the child develops muscle control which develops bodily/kinesthetic intelligence. Problem solving & thinking skills are developed while trying to imitate the patterns; that promote logical/mathematical intelligence. 12 Patterns are provided.

W 30 x H 30 x L 4 cm



**Educational
Toys**

+3 **NEW**

21030

Pre-Writing Board Set ▶

A set of 4 pre-writing tracing boards with a wooden pencil for endless numbers of practice. It helps children learn how to hold a pen and practice their first lines. Develop pre-writing and motor-memory skills that will be needed later in writing skills, enhancing bodily/kinesthetic intelligence. Made of high quality natural wood with non-toxic paints conforming to European toy safety standards.

W 33 x H 10 x L 1.8 cm



+3½ **NEW**

Stacking Tower ▶

Brightly colored shapes which a child tries to collect and arrange logically until he/she completes the tower. Helps the child to recognize shapes, differentiate between colors and develops solving problems skills which all help promoting logical / mathematical intelligence. While assembling the shapes together hand/eye coordination is developed; this reinforces bodily-kinesthetic intelligence. Made of high quality natural wood with non-toxic paints conforming to European toy safety standards.

W 7 x H 7 x L 21.5 cm



Grading circular tower 21187



Stacking shape tower 21188

+5

20140

Geoboards 6 ▶

These colorful double-sided (15cm) square geoboards feature a 24-pin circular array on one side and a 5 x 5 pin grid array on the other. Each set includes 6 colors and a pack of 120 elastic bands. It allows students to do geometric thinking helping in developing logical/mathematical intelligence.





Goldilocks and the Three Bears 21225



Little Red Riding Hood 21230



Pinocchio 21220



Hansel and Gretel 21235

+4

Fairy Tales

A series of wooden puzzles telling world famous stories. Made in a new shape which consists of a pattern, wooden base and stand. The child arranges the wooden pieces to match the pattern. This builds up the child's power of expression and logical thinking helping Logical/Mathematical and linguistic Intelligence to be enhanced. Available in 4 themes (Pinocchio, Goldilocks and the three bears, Hansel and Gretel and Little Red Riding Hood).

W 19 x H 26 x L 5.5 cm



+3 NEW

Building Up Body Parts Puzzles

Colorful designed three layered puzzles which begin with a naked body, then body parts and underwear base and finally a fully dressed boy or girl. Teaches body parts and clothing items to develop linguistic and logical/mathematical intelligences. The product is available with or without the naked body.

W 36.5 X H 25 X L 0.9 cm



11510 (2 layers)



11525 (3 layers)



11580 (3 layers)



11530 (2 layers)



Girl 11540



Boy 11535

+3 NEW

Know Your Face Puzzles

Attractive design for girl and boy face puzzles. Removable parts of the head and face help develop logical/mathematical intelligences. Hair, eyebrows, eyes, ears, nose, mouth and neck are all removable to encourage conversation and develop vocabulary helping children to reinforce linguistic intelligences.

W 25 X H 25 X L 0.9 cm



+4

What are You Doing ? ▶

A set of wooden puzzles that help the child's creative thinking and problem solving powers which help in enhancing Logical -Mathematical intelligence. The set includes a list of verbs that are used in daily life. Helps self expression and increases vocabulary leading the Linguistic intelligence to be developed.

W 21.3 x H 21.3 x L 0.9 cm



Taking a Bath 11980



Running 11975



Drinking 11960



Sleeping 11965



Waking Up 11985



Playing 11950



Reading 11955



Eating 11970

+3 **NEW**

Insert Boards

Inset cut-out shapes in a wooden base promote shape recognition, developing logical/mathematical intelligences. All the topics included (vegetables, fruit, mealtime, wild animals and farm animals) are likable for children which encourages them to talk and learn new words developing their linguistic intelligences.

W 32.5 x H 20 x L 1.8 cm



Farm Animals 10020

Wild Animals 10025



Vegetables 10005



Mealtime 10015



Fruits 10000

+4 NEW



21100

Geometric Fractions

A wooden board depicts shapes and their fraction pieces. Children Learn about geometry, fraction and shapes while building different shapes on the wooden base enhancing logical/mathematical intelligence. It also promotes hand-eye coordination and small motor skills developing bodily/kinesthetic intelligence. It Can be used to teach simple sums. W 32 x H 9.5 x L 4 cm



+4 NEW

21105

Shape Matching Board

The nine shapes on this sturdy wooden board helps children learn that a shape can have different looking symmetrical halves as they match corresponding pieces to form a circle, square and hexagon. Enhances the logical/mathematical intelligence.

W 21.5 x H 21.5 x L 3.5 cm



+3 NEW

21155

Geometrical peg Grading Board

Ideal educational toy which promotes logical/mathematical intelligences by teaching children multiple concepts (shapes, height and color) through fun. Children will stack the wooden pieces in the appropriate place on the sturdy wooden base developing hand-eye coordination and small motor skills enhancing bodily/kinesthetic intelligence.

W 21.5 x H 21.5 x L 8.5 cm



+3 NEW

Which is the Tallest .. ?

Both a toy and educational aid to improve the creative and inventive powers of the child. Helps the child understand some math conceptions such as order and sequence helping in improving logical/mathematical intelligence. It also can be used in differentiating between the colors developing spatial intelligence. Children also are given the chance to create artistic shapes from the pieces of varied lengths and colors. Available in three forms.

W 22.5 x H 14 x L 4.4 cm



+ 6 **NEW**

31370

3D Cubes

64 differently colored wooden bricks with 24 dimensional patterns in three grades of difficulty. The child arranges the bricks according to the patterns. This toy develops many geometrical concepts like the awareness of space, spatial insight and problem solving skills which improves logical/ mathematical intelligence.

W 2.5 x H 2.5 x L 2.5 cm



**Educational
Toys**



Farm 10800

+ 4

Trip to ...

An exciting and interesting toy. Helps to develop language and the imagination. Gives the opportunity for a child to make up stories which will lead the linguistic Intelligence to be enhanced. Consists of a base and wooden pieces expressing a theme, in addition to the availability of 20 patterns. The child arranges the pieces according to the pattern helping the spatial intelligences to develop. (Available in two themes circus and farm).

W 29.5 x H 20 x L 12 cm



Circus 10805

+4 NEW

31130

Classification Box

This amazing toy is an ideal tool for teaching a child how to classify objects by category - the beginning of conceptual thinking- and as a result logical/mathematical intelligence are developed. Consists of a 4 basic tiles printed on both sides featuring 8 categories and 80 wooden object tiles to sort by class. The child can start with one or two categories and work up to sorting 4 categories at the same time. Answers are easily checked by removing sorted tiles from each compartment and comparing them to the category guide card. Helps Linguistic intelligence to be Promoted. W 25 x H 12 x L 7 cm



+3 NEW

31100

Sorting Box

Children sort wooden tiles by placing them into slots corresponding to figures on the guide strip. Six guide strips featuring animals, fruits and vegetables, clothes, colors, shapes and numbers encourages new vocabulary and as a result linguistic intelligences are developed. Children will love how many different games and activities this box allows which encourages logical/mathematical intelligence.

W 40 x H 12 x L 7.4 cm



+2 NEW

31135

matching box ▶

A shape sorter toy but in a creative look. It helps develop shape recognition ability promoting logical/mathematical intelligence. Four guide strips featuring farm animals, wild animals, transportation and different types of trees in simple illustration for little ones. Children will search for the matching figure and put them by corresponding holes enhancing Hand/Eye co-ordination as a step in bodily/kinesthetic intelligence development.

W 25 x H 12 x L 7 cm



+3 NEW

31125

Small Sorting Box

The same popular sorting box but in a smaller size. Four guide strips featuring pets, food, transportation and toys encourage new vocabulary and as a result linguistic intelligences are developed. Follow one of the included guide strips and slip tiles through appropriate slots promoting classification and sorting helping logical/mathematical intelligence to enhance.

W 25 x H 12 x L 7.4 cm





+3

862
Faces and Expressions

A complete kit for making funny or serious faces with different ages, racial features and expressions. It includes a board with 2 blank faces and more than 50 plastic parts with eyes, ears, mouths, noses, glasses, moustaches and hair to fix with adhesive textiles. Ideal for dialogues about individual differences and tolerance. A great educational tool for enhancing Linguistic and intrapersonal intelligence.
 size: 65x48 cm.



+4

720
Cause and consequence

24 plastic cards with simple positive and negative sequences with environmental concepts. Ideal for Linguistic and Logical/ Mathematical intelligence development.
 Card size: 8,5x12cm



+4

870
Maxi-Seasons

A set of 4 large trees representing each season with related objects on interactive circles to put and take off. The title card for each tree is blank for the teacher to write the name of each season. Promotes Linguistic and intrapersonal intelligence. Contents: 4 trees, 4 title-cards, 28 circles and adhesive textile attachments. Each tree and title card has a plastic dry-wipe surface.
 Size: 53x72cm.



+3

31026

Squared Domino

Totally different shape for Dominos. Square not rectangle domino pieces that gives the game a distinguish look. Children can also use the colorful pieces to make mosaic design. Dominos is one of the games which reinforce the interpersonal intelligence. Differentiating between colors while playing promotes the logical/ mathematical intelligence.

Square Size : 5 x 5 cm



Geometrical domino 31035



Animals domino 31040

+3

Touch and match dominos

Children will enjoy this different domino game with raised shapes. It increases vocabulary helping in developing Linguistic intelligence. Also improves matching through sight and touch which helps enhance logical/ mathematical intelligence. The raised shapes make it suitable for blind children because it can be played by using the sense of touch. Available in (geometrical or animal) shapes.

Box Size : W 37.5 x H 23 x L 3.6 cm



+4

New look Picture Domines

A delightful version of the picture domino game. The cute animal pictures are printed on colourful wooden backgrounds to attract children and help develop their matching skills leading logical/ mathematical and linguistic intelligence to be developed. They come in two themes- farm animals and wild animals

Box Size : W 37.5 x H 23 x L 3.6 cm



Wild Animals 31025



Farm Animals 31030

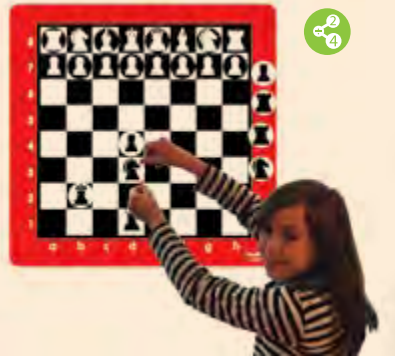

+1

1022

Vertical chess

A large magnetic chess for playing both vertical or table top surface. Chess improves learning, thinking and decision making ability for children. Perfect for logical/ mathematical intelligence. Contains a light plastic numbered board with 32 round flexible magnetic pieces.

Size: 59x60cm



+4

30582

Where is My Button?

A memory game but in a very different way which make it an interesting game strengthens Intrapersonal Intelligence. T-shirts & patterns are distributed on children and they have to pick up the right button. All buttons are arranged as a memory game and children need to remember where the right button is. It can be played for younger children as a classification game developing Logical/Mathematical Intelligence. 24 patterns, 8 T-shirts and 24 buttons.

W 33 x H 18 x L 4.5 cm



+4

30583

Color Hunt

A memory game but not like any ordinary memory game. The base of the memory is movable so it can be played in a different arrangement every time. It can be divided for more than one group to play. Very interesting game strengthens Intrapersonal and Spatial Intelligence.

W 16.5 x H 16.5 x L 5.5 cm



+4 NEW

22405

Popcorn Balance Game ▶

The child arranges the popcorn pieces in the wooden bowl intelligently to include the biggest number of popcorn pieces. It contains different sized pieces (Shaped like Popcorn) with a base representing a popcorn bowl. Develops problem solving & logical thinking skills. Ideal for developing the Bodily/kinesthetic and Logical/Mathematical Intelligence. W 12.5 x H 6 x L 2 cm





+2

1000 Light Table ▶

A new learning aid that captivates the child's interest and enhances concentration through play. Ideal for sensorial integration. It also develops the child's imagination and creativity. Can be used for promoting logical/ mathematical and linguistic intelligence. A wooden table with a 3mm white acrylic top, led lights, a remote control and a bottom shelf. The table legs can be removed for the use of younger child.

size:90x55x45cms.



+2

1014 2D Shapes

Great translucent stencils for using with light tables. Children can learn shape discrimination, color mixing and drawing by using these shapes. A good educational toy for promoting logical/ mathematical and linguistic intelligence.



+2

39160

Color Paddles

Children will explore mixing colors with these color paddles. Paddles are in 6 colors, 8 x 14cm long. Color recognition is promoted therefore spatial intelligence is developed.

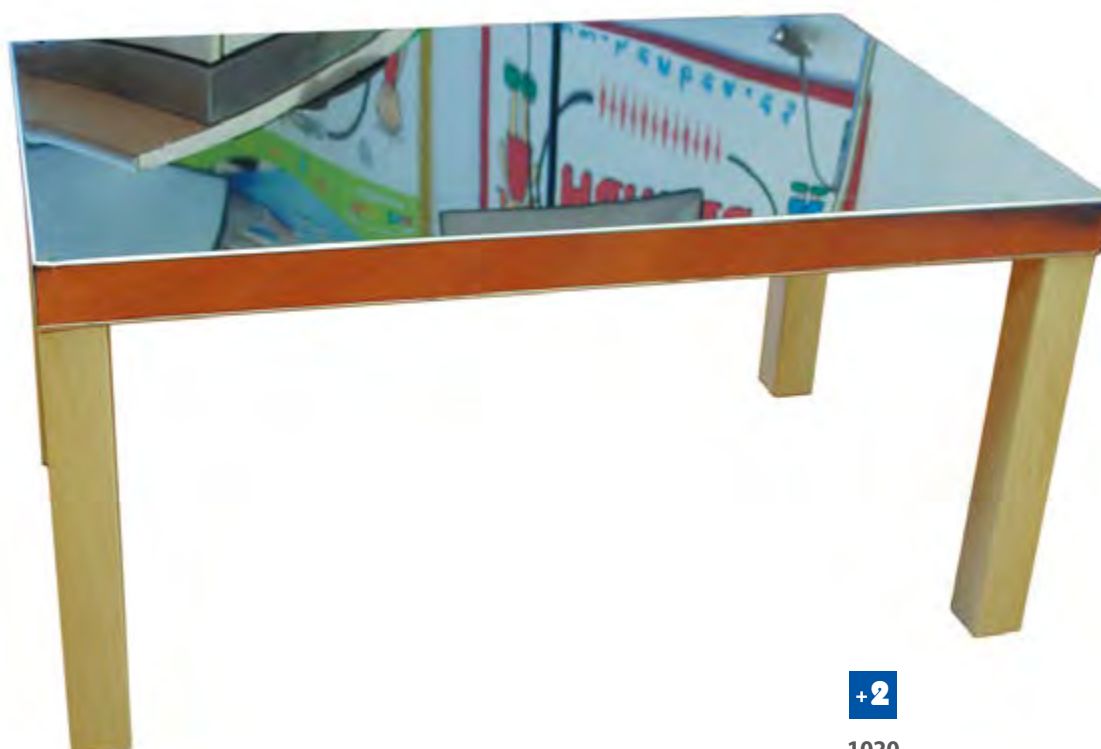

+2

1020

Mirror table

A table that gives hours of entertainment and learning in either free play or directed activities. It works on developing logical/ mathematical, linguistic and intrapersonal intelligence. Using it as a base in combination with various materials, lots of symmetry, refraction and reflection experiments can be done. A great nature table for observing outdoor objects.





Language

Language development begins by association in children's minds long before they utter their first words. To begin with they are silent observers, and then they begin to articulate by producing sounds. Words and then sentences follow in due time. After they have acquired speech the next stages for developing and mastering a language are reading and writing. EDU FUN provides quality products which help children to develop their *Linguistic Intelligence* through every stage of their development.





+3

Alphabet Board

These puzzles help familiarize children with letters of the alphabet from a young age which develops the linguistic intelligence. May be used to form simple words. Available in: English capital letters & small letters.

W 36.5 x H 25 x L 0.9 cm

ABC



B 12010 / Small



A 12005 / Capital

Language



+3

12020

What's Inside My Alphabet ?

Learn the shapes and forms of the letters and simple words. A picture corresponding to a letter is revealed when the letter is removed. An important educational toy for developing linguistic intelligence.

W 36.5 x H 25 x L 0.9 cm

ABC

+3

61085

Alphabet Bean Bags

Colorful 10cm bean bags offer many opportunities for learning and play. Great for developing gross motor skills leading bodily/kinesthetic intelligence to be promoted. 5 colors and 26pcs in a set.

ABC



+3

805

Vowels for threading

Specially designed as a manipulative, pre-writing activity. It guides children towards a correct letter formation. Capital and cursive letters have been printed in the corners to relate with the main letter. Ideal for bodily/kinesthetic intelligence development.

Card size: 23x15cm

ABC





+3

32025

▶ Spell - A - Word

The child fits pieces together to spell words which help in promoting the linguistic intelligence. It contains 10 pictures divided to 3 to 6 pieces.

Box Size : W 33 x H 18 x L 4.7 cm



32005

▶ Play & Learn Alphabet

An interesting & attractive introduction to the alphabet in puzzle form. The colorful original drawings are matched to a piece indicating the first letter of the word itself. Self-correcting as incorrect answers do not fit together. Ideal for developing spatial and Linguistic intelligence.

Box Size : W 33 x H 18 x L 4.7 cm

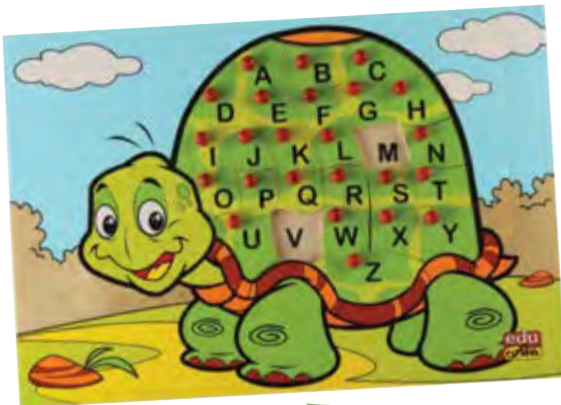

A 12115 / Turtle

+3

▶ Letter Puzzle

It has been agreed about the importance of a child being taught the basic alphabet letters before entering school. We have produced an educational toy which is both exciting and attractive. Formed in the shape of animals which are loved by children, who arrange the letters in order in an animal's shape. Helps in developing Linguistic and bodily/kinesthetic intelligence.

W 36.5 x H 25 x L 1.8 cm



B 12105 / Fish

+3

12025

What's Inside My Alphabet ?

Learn the shapes and forms of the letters and simple words. A picture corresponding to a letter is revealed when the letter is removed. An important educational toy for developing linguistic intelligence.

W 36.5 x H 25 x L 0.9 cm

ABC



Language

+3

12000

Alphabet Board

These puzzles help familiarize children with letters of the alphabet from a young age which develops the linguistic intelligence. May be used to form simple words.

W 36.5 x H 25 x L 0.9 cm

ABC

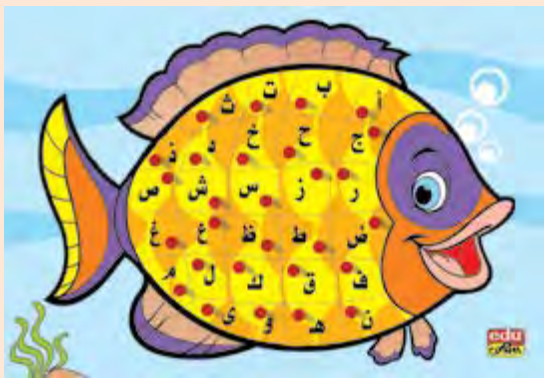

A 12100 / Fish

+3

Letter Puzzle

It has been agreed about the importance of a child being taught the basic alphabet letters before entering school. We have produced an educational toy which is both exciting and attractive. Formed in the shape of animals which are loved by children, who arrange the letters in order in ..an animal's shape. Helps in developing Linguistic and bodily/kinesthetic intelligence.

W 36.5 x H 25 x L 1.8 cm

ABC

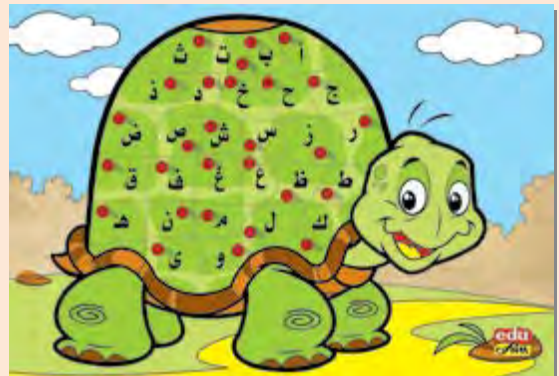

B 12110 / Turtle



+3

32000

Play & Learn Alphabet

An interesting & attractive introduction to the alphabet in puzzle form. The colorful original drawings are matched to a piece indicating the first letter of the word itself. Self-correcting as incorrect answers do not fit together. Ideal for developing spatial and Linguistic intelligence.
Box Size : W 33 x H 18 x L 4.7 cm



+3

32025

Spell - A - Word

The child fits pieces together to spell words which help in promoting the linguistic intelligence. It contains 10 pictures divided to 3 to 6 pieces.

Box Size : W 33 x H 18 x L 4.7 cm



+5

12085

Magnetic Arabic Alphabet

We are proud to present to you one of our most important contributions in the field of Arabic language teaching, which is the product of Arabic magnetic letters.

An enjoyable way to learn Arabic letters, consisting of 170 magnetic letters, to teach the shape of the letter in its different position.

All letters and dots are colored in one color so that the learner can distinguish them according to their form (shape) only. The punctuation marks are given a different color than the letters to distinguish them and not to mix them with the letters. It enables the learner to form words and sentences with the help of the patterns provided.

Patterns are available presenting 3 different levels of exercises. Helps in developing the spatial and Linguistic intelligence.

Language



+5

31360

Arabic Alphabet Blocks ▶

A completely innovative design for the Arab world to help your child to spell or to recognize the different formation of letters according to their position in the word. Ideal for developing linguistic intelligence. Consists of 43 letter blocks, 20 blocks for diacritical marks and 2 stands which can be assembled and un-assembled. All contained in a wooden box. Patterns are available presenting 2 different levels of exercise.

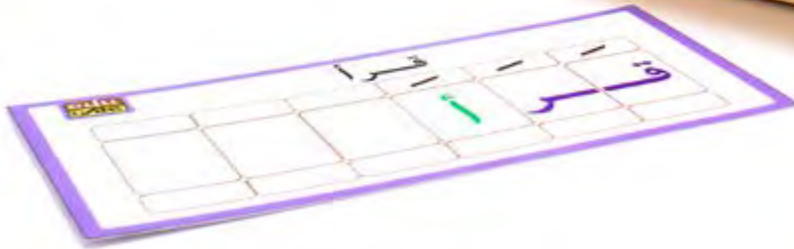

Language



Mathematics

Mathematics is an essential subject for understanding ways of life and how our world works. If this is begun in an easy and entertaining way child will accept it easily and enjoy learning more. It's never too early to introduce basic Math concepts to children. EDU FUN provides an entertaining variety of educational aids and toys to capture children's interest and help to strengthen their Logical/Mathematical Intelligence and understand basic Math concepts.





+3

Counters

Children learn valuable language, math and classification skills when using these counters. Sorting, counting, patternmaking, sequencing and symmetry skills help logical/ mathematical intelligence to be promoted. Different shapes and characters encourage children to learn new vocabulary and therefore Linguistic intelligence is enhanced.



Transport Counters - 13140C



Fruit Counters - 13120C



Wild Counters - 13026C



Backpack Bear Counters - 13100C



Vegetable Counters - 13130C



Farm Animals Counters - 13200C



Aquatic Counters - 13150C

+3

13710C

Counting Sticks

Great way to develop children's skill in counting, sorting, addition, subtraction and measuring. Ideal for enhancing logical/ mathematical intelligence. 1000pcs in 10 colors. Each stick measures 3mm dia. x 10cm long. Comes in a sturdy plastic container



+3

Links

Set with 500 pcs In sturdy plastic container. Sorting, counting, patternmaking, sequencing, symmetry, measurement and estimation skills will be learned by this toy which helps develop logical/ mathematical intelligence.



85049 (4 colors)

Transport Counters - 13140C



14031 C (6 Colors)

+3

85050 Giant Counting Links

Set with 200 pieces in 4 colours Easy to manipulate and durable. To promote eye-hand coordination, sorting, counting and colour differentiation. For ages 3 years



Mathematics

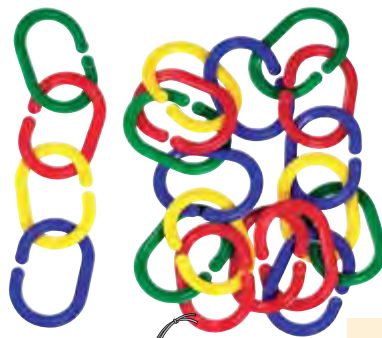

+4

900378

Geo Links

This set consists of: 120 links in 3 different shapes (square, triangle and circle) , 4 different colors.16 work cards are included, printed in color and in black and white with colors represented by symbols (recto is the self-correction of the verso).There are 4 different series of work cards – each with its own symbol. If you use them together, you will always have enough links! Children should start with the colored side. Afterwards they can continue with the more difficult side. Ideal material to develop fine motor skills and think logically helping bodily/kinesthetic and logical/ mathematical intelligence to be developed.

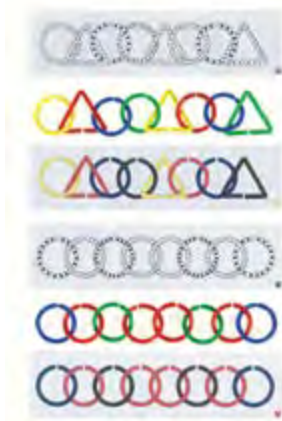

+4

14124C Shape Link Activity Set

When Students play with this toy, they develop important skills like sorting and classifying, patterning and sequencing, logical reasoning, creative design and basic numeracy. All these skills help enhance logical/ mathematical intelligence. Set includes 360 links in 3 shapes and 6 colors, 20 x 2-sided activity cards, and a sturdy plastic container.





+3

15912

First Sorting Kit ▲

The First Sorting kit contains basic shapes, bears and fish, total 132 pcs. No small parts! Safe for young children learning early math, colors, classifying and sorting which help in developing logical/mathematical and linguistic intelligence. Lid included



+4

15910 ▲

Counting and Sorting Set

This classroom set of counting and sorting manipulative comes with a large eight compartment storage tray, student activity cards and a comprehensive teacher's guide. The set contains three overhead spinners, number dice, six sorting bowls, color counters, linking links, pattern blocks, stackable counters, fruit counters, transport counters, farm counters, dinosaur counters, and bug counters. Set contains more than 700 pieces. A perfect set for improving logical/ mathematical and linguistic intelligence.



Mathematics



+3

723

Numbers for threading

Learn the numbers by threading and tracing with these cards. Beads are printed on each card for relating the quantities. The kit includes 10 numbers 0 to 9 and 10 laces. Ideal for bodily/kinesthetic intelligence development.

Card size: 16,5x11cm



+1

20007

Giant toddler abacus ▼

This giant abacus for young children encourages them to learn to count helping the logical/mathematical intelligence to develop from young age. Bright colors and large size makes it suitable for children from the age of two. Main educational aid for nurseries or activity centers for children. It can be folded for easy storage.



+3

20010

Build up abacus

This abacus is different! It can be used for Individual playing or group learning. Ten bars with 5 different bead colors. It can be separated or stacked up like a traditional abacus. Children can Start with only one or two bars to focus on simple counting without overwhelming them with larger numbers. Separated bars can be stacked in different heights or connected to build various shapes and designs. Helps in developing Logical / mathematical intelligence Made of high quality natural wood with non-toxic paints conforming to European toy safety standards.





+3

20070

Counting abacus ▲

This traditional abacus consists of 10 differently colored rows of wooden beads. It helps to introduce the basic concept of counting, addition and subtraction promoting logical/mathematical intelligence.



+3

20060

Triangle abacus & tracing ▼

This is a unique shape for the traditional abacus with a new twist. Two sides of the triangle are an abacus whilst the third side is a tracing board. To encourage hand-eye coordination with left to right movement prompting bodily/kinesthetic intelligence. Color and number discrimination helps to develop Logical / mathematical intelligence.



+3

26102C

Place Value Abacus ▼

Set comprises 3 stands, 9 rods, 81 abacus beads, 9 sets of 0-9 number tiles, in a sturdy plastic storage container. Children can join two spinner to generate six-digit Numbers. Perfect aid for grasping the place value concept which lead toward logical/mathematical intelligence development



+3

13340C

Stacking Counters ▼

This set includes 500 stacking counters in 10 bright colors, 20mm dia. Sorting, counting, patternmaking, sequencing and symmetry skills help logical/mathematical intelligence to be promoted Comes In sturdy plastic container



12075

What's Inside My Numbers? ▼

One tall giraffe, two cute cows, ..etc. The perfect way to learn counting from 0 - 9. Take the numbers out of the board and surprise!.



12055

Number Board ▲

With these colorful wooden numbers children become familiar with numerals and their shapes. They can be used as a guide for writing or even to make larger numbers.

+3 **NEW**

40100

Geo Fun

Learn sorting, counting and patterning with these geometric shaped colorful beads. Ideal for developing fine motor skills. Helps logical/ mathematical and bodily/kinesthetic intelligence to be developed. Set includes 36 beads in 6 geometric shapes and 6 colors, 2 stand 6 rods, and 10 * 2-sided activity cards.



Mathematics



25895

Student Math Balance

Ideal for students to learn about basic number equivalence and operations. It is a very good tool for developing logical/ mathematical intelligence. Includes 20 weights, balance is 36cm long and 13cm high. Classroom set of 10 Number Balances.

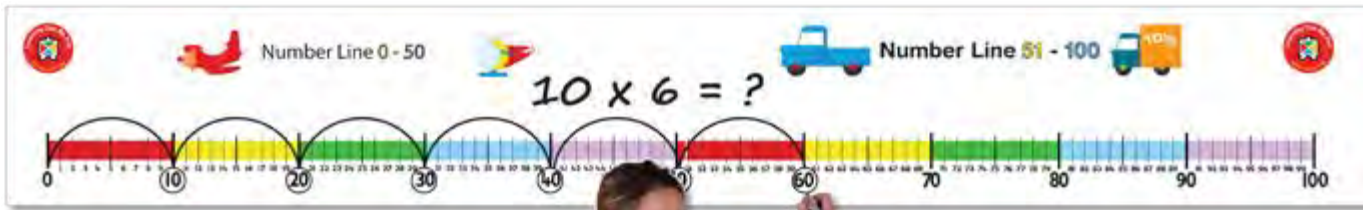

+5

LNLL 100

Wall Number Line 0-100 & Pen

The large format of this Wall Number Line is designed to encourage whole class participation. It consists of two sections, each measuring 27.5cm x 100cm. Introduce the Number Line 0-50 first or join the two sections together to form an attractive Classroom Number Line 0-100 measuring 27.5cm x 2m. Different colours have been used to highlight each group of 10 numbers. This resource can be used for a whole class activity or by small groups of students to develop many skills: counting, positional terms, addition, subtraction and multiplication calculations. A whiteboard marker is supplied, for use on the write on/wipe off. Ideal for developing logical/ mathematical intelligence. laminated surface. **2M LONG**



+5

LNLS100

Student Number Line 0-100 Pack of 10

Place value and basic number facts are combined to perform mental and written calculations so it is important that the foundation of place value is solid. Our freestanding flip chart features 4 sets of flips, each with number 0 - 9, ones to thousands, will definitely help for better understanding. It is a good tool for enhancing logical/ mathematical intelligence.

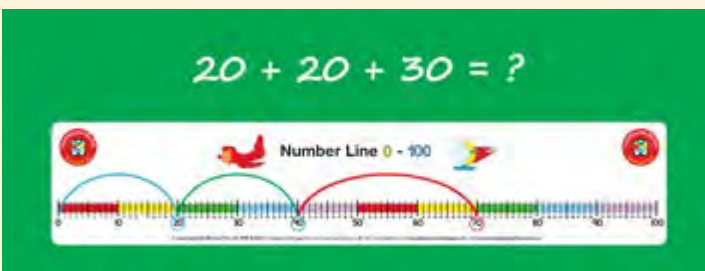

+5

21271

2D/3D Geo Shape Flip Chart ▶

The 2D/3D Geometry Flip Charts help students learn about the relationships between 3D objects, 2D nets, vertices, faces and edges. Students can also learn geometry and measurement topics, including shape comparison, describing, symmetry, shapes, area, Euler's rule and more. Ideal aid for promoting logical/mathematical intelligence. The colors of 2D nets match our 2D/3D Geometric Solid set (21341).



Mathematics

+4

▶ **Place Value Flip Chart**

Place value and basic number facts are combined to perform mental and written calculations so it is important that the foundation of place value is solid. Our freestanding flip chart features 4 sets of flips, each with number 0 - 9, ones to thousands, will definitely help for better understanding. It is a good tool for enhancing logical/ mathematical intelligence.

26023 Student size, pack of 10, 21cm x 9cm.
26024 Demo size, single, 31cm x 15cm



+3

19550

Attribute Blocks ▶

This set includes 60pcs in 2 sizes, 2 thicknesses, 3 colors and 5 shapes, packaged in a plastic container with sorter lid. The bottom of tray can be used as a template. A multi-purpose math kit that may be used throughout pre K - 6 to help children identify colors and shapes, sort and classify by attributes (features) - size, thickness, color, and shape. It also helps them learn 2D geometric shapes. Ideal for developing critical thinking skills through logic and reasoning leading logical/ mathematical intelligence to be developed.

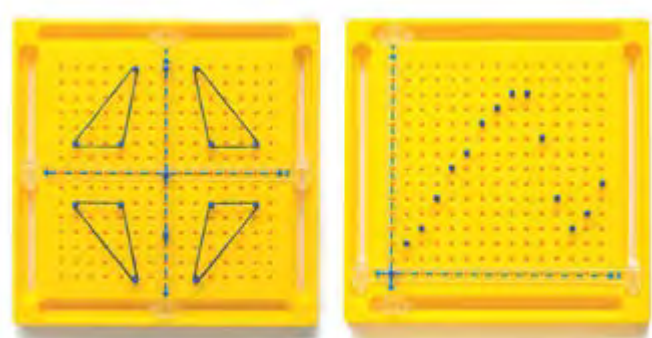

+4

20701

X-Y Coordinate Pegboard ▶

This 24.5cm x 24.5cm peg board has two sliding axes lines that allow students to do algebraic thinking. Using the pegs and rubber bands that come with the board students are able to do functions, conic sections, and line segments leading to better logical/mathematical intelligence. Set includes 5 pegboards, 250 pegs (red, blue) and 100 rubber bands.



21347

2D/3D Geometric Solids ▶

Advanced set of 12 folding 2D/3D geosolids including cube, cylinder, cone, triangular prism, square pyramid, triangular pyramid, rectangular pyramid, pentagonal pyramid, hexagonal pyramid, rectangular prism, pentagonal prism, and hexagonal prism. Ideal for exploring the properties of 3D solids, relationships between 2D shapes and 3D solids, volume and capacity, and surface area helping logical/mathematical intelligence to improve. Set includes 12 solids made of durable plastic with rounded corners and edges, and 12 corresponding folding nets in 6 colors made from soft plastic. The solids have an 8cm base. Activity guide included.



Mathematics



21317

Geometric Solids ▲

Advanced set of 12 geosolids including cube, cylinder, cone, triangular prism, square pyramid, triangular pyramid, sphere, hemisphere, rectangular prism, pentagonal pyramid, pentagonal prism, and hexagonal prism. Children will understand geometric solids better by this set, which indeed helps logical/mathematical intelligence to enhance. Made of durable plastic, with rounded corners and edges. 8cm base, 12 solids and 6 colors.



25030

Basic Geometric Volume set

Children will explore volume concepts by pouring from one container into another. They will learn that the volume of a cone is one-third the volume of the associated cylinder. This set helps in developing geometric skills therefore logical/mathematical intelligence is enhanced. Set includes 6 clear plastic shapes: cone, sphere, cylinder, cube, pyramid and rectangular prism. 10cm base, 6pcs.

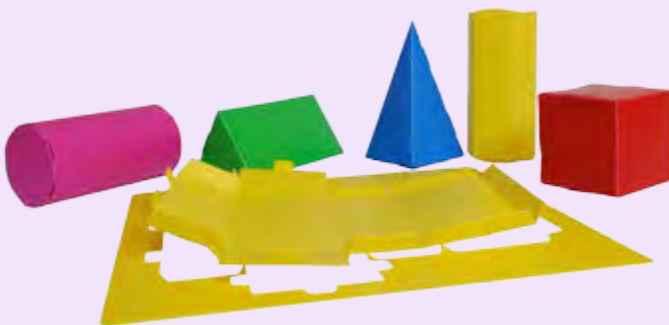

Geos - 813

Geos

Geometrical shapes for assembling and studying 3D shapes. It can be used flat as a stencil and compare capacities in the case of the Transparent Geos. Ideal for logical/mathematical intelligence developing. Contains 6 shapes: a cube, a triangular prism, a hexagonal prism, a parallelepiped, a cylinder and a pyramid.

• Measurement: 35x35 cm



Transparent Geos - 861

21373C

Skeletal Geo Set ▶

Make your own 2D figures and skeletal 3D models. Learn about vertices, faces and edges while involved in constructing new models. Perfect for developing logical/ mathematical and bodily/kinesthetic intelligence for children. 330pcs, includes 60 white balls, sticks of 50 each of 3.3cm, 5.3cm, 6.9cm, 30 each of 8.2cm, 10.5cm, 12.5cm and 30 x 1/4 circles with 20 2-sided activity cards.



21365C

Junior Stick ▲

Improve fine motor skills and develop creative thinking skills with this cute construction set. 10 different length flexible sticks that snap together. The set includes 200 flexible plastic sticks, and 30 x 2-sided activity cards. An ideal set for developing logical/ mathematical and bodily/kinesthetic intelligence for children from 3 to 99! Sizes range from 2.5cm to 15cm.



21372C

▼ **Skeletal Starter Geo Set**

Construction Set which will improve children's fine motor skills, as well as develop their creative and problem solving skills. It can help promote logical/ mathematical and bodily/kinesthetic intelligence for children. Build two and three dimensional structures. Introduces 80 sticks in 4 sizes and 4 colors. 40 connecting balls in two colors, 24 quarter circles, and 20 (2-sided) activity cards, in sturdy container





Montessori Products

The Montessori Method is one of the greatest methods in the educational field. The main concept of Montessori is to promote the joy of learning. This joy of learning develops a well-adjusted person who has a purpose and direction in their life. Children, who experience the joy of learning, are happy, confident, fulfilled children. Therefore, we have brought you these high quality Montessori materials with very competitive prices to continue our contribution in the educational field.







+1 NEW

91000

◀ Single shape puzzle set

These four single piece puzzles are ideal for introducing infants and toddlers to shapes. Large circle, small circle, square and triangle.

+1 NEW

91001

Multiple shape puzzle set ▶

Two wooden boards with large knob to be easy for little ones to hold. Circle, triangle and a square in one board, and the other has 3 sizes of a circle.



Montessori Products

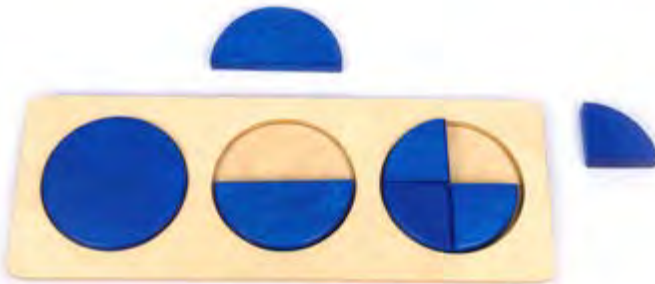

+1 NEW

91002

◀ Circles

This wooden board helps infants to learn about circle fraction. Easy to grip for little children use.



+1 NEW

91004

◀ Squares and triangles

This wooden board helps infants to learn about fraction. It demonstrates the relation between square and triangle shapes. Easy to grip for little children use.

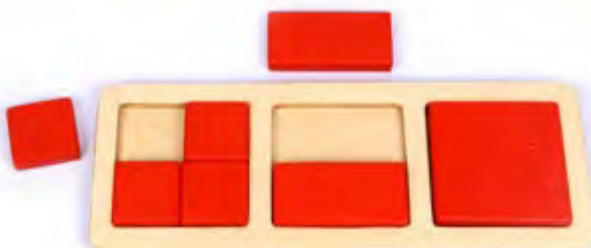

+1 NEW

91003

◀ Squares and rectangles

This wooden board helps infants to learn about fraction. It demonstrates the relation between square and rectangles shapes. Easy to grip for little children use.

+1 NEW

Imbucare boxes

This materials provide an infant with the possibility of fitting objects into holes which is a natural inclination for young children. This activity gives the child practice with hand-eye co-ordination as the shape is put through the hole. The shape is then easily retrieved from the front of the box to repeat the activity over and over.

91010
Imbucare box with small cylinder ▶



91013
◀ Imbucare box with triangle prism

91014
Imbucare box with rectangular prism ▶



91012
◀ Imbucare box with cube

91011
Imbucare box with large cylinder ▶



+1 NEW

Infant dowel boards

These materials focus on hand-eye co-ordination and manipulative skills. It also helps the child to practice with different finger grasps based on the shape of the object.

91005
Cubes on vertical dowel ▶



91006
◀ Discs on horizontal dowel

91007
Discs on vertical dowel ▶



91009
◀ 3 Discs on a vertical dowel





Montessori
Products



+3 NEW

91100

▶ **Pink Tower**

The Pink Tower is a foundational material from the Sensorial Area of the Montessori classroom. 10 pink wooden cubes varying in size from 1cm cubed to 10cm cubed. Ideal for helping children with visual discrimination of dimensions.



+3 NEW

91101

▶ **Brown Stairs**

10 brown prisms of the same length (20cm) but differing in height. It helps in preparing children for geometry, area and volume.

+3 NEW

Cylinder blocks

Set of 4 blocks with cylinders varying in height and/or diameter in each block. To help develop the child's visual discrimination of size.



91106
◀ Cylinder blocks 1



91107
◀ Cylinder blocks 2



91108
◀ Cylinder blocks 3



91109
◀ Cylinder blocks 4

+3 **NEW**

Knobbles cylinders

Four boxes each with a set of 10 cylinders varying in height and/or diameter in each set.

Each set is in a separate wooden box with the lid painted the same color as the cylinders - red, green, yellow and blue.



91102
◀ Knobbles cylinder model 1



91103
◀ Knobbles cylinder model 2



91104
◀ Knobbles cylinder model 3



91105
◀ Knobbles cylinder model 4

+3 NEW

91117

Mystery Bag Geo ▶

Hide the wooden shapes in the bag and test child's senses and his recognition of shape skills. A set of 2 cloth bags that each one of them containing a set of small geometric solids for matching.

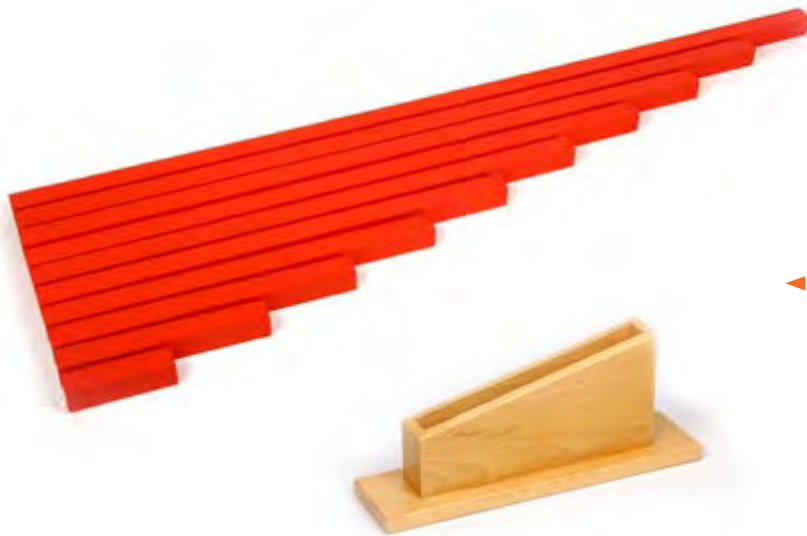

+3 NEW

91110

▶ **Red long rods**

Ten, red wooden rods. The height and width are constant. The lengths increase by ten centimeters from the shortest rod.

Montessori
Products



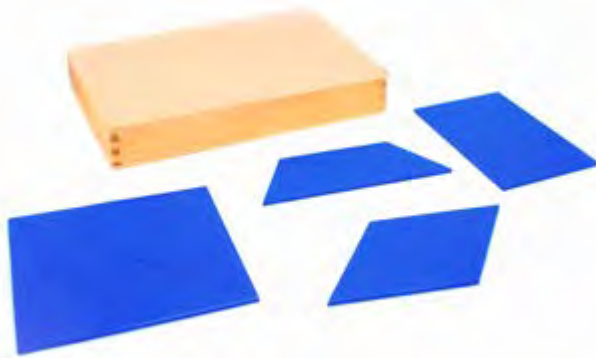

+4 New

91112

Constructive Triangles

The constructive triangles are used to demonstrate that all plane geometric figures can be constructed from triangles. Each box contains triangles of different sizes, shapes, and colors. It provides a foundation for later concepts of equivalency, similarity, and congruency.



Montessori Products

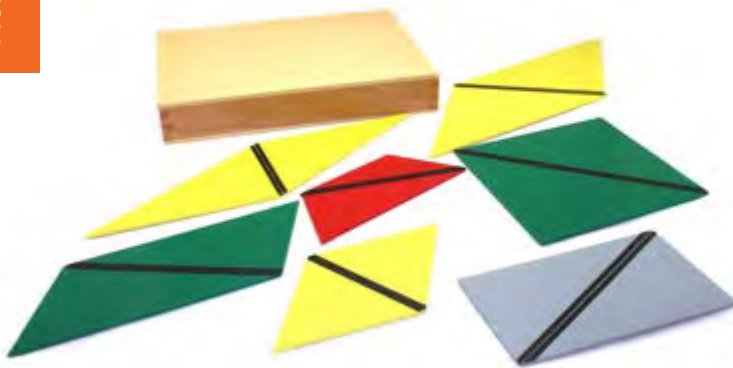

+3 NEW

These much loved practical life materials really engage children. They strengthen fine motor and hand muscles.



91119
◀ Key and lock

91120
Screwdriver and nails ▶



91121
◀ Nut and bolt board

91123
lock board 2 ▶

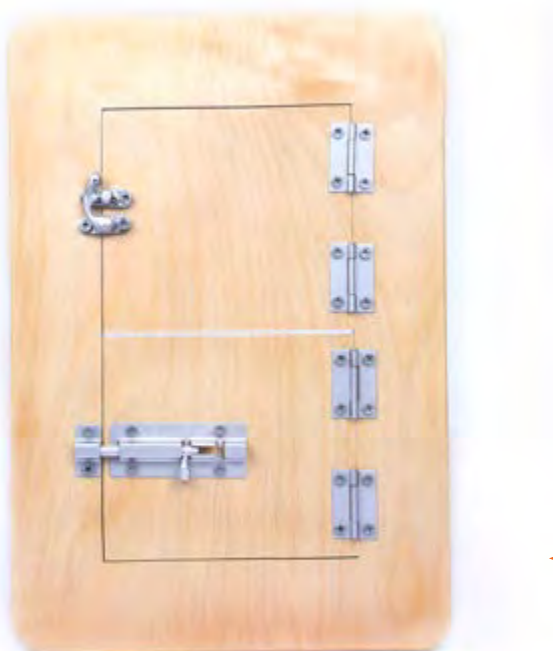

91122
◀ lock board 1



91205
◀ Pencil tray



91206
Colored pencil holder ▶



91207
◀ Box Paper



Montessori
Products

NEW

91208

Metal insets shelving unit ▶

A shelving unit for holding metal insets and the accompanying materials.



+4 NEW

91211

▶ **Grammar Filling Boxes**

A set of 36 Color-coded boxes for organizing the grammar cards. The colors of each exercise box corresponds to each color-coded for Parts of Speech.

+4 NEW

91215

Grammar Boxes ▶

A set of eight wooden boxes with varying numbers of compartments. These boxes are color coded according to the corresponding parts of speech.



+4 NEW

91212

▶ **Nomenclature Card Holder**

The Nomenclature Card Holder set includes six wooden boxes, each divided into five slots. Each box has a natural wood finish with one coloured face.

91213

Grammar Command Box, WOODEN ▶



+4 NEW

91214

▶ **Grammar Command Display Boxes**

Set of nine colored wooden boxes for storage of the Command Cards. the set includes: 1 black, 2 brown, 2 red, 1 purple, 1 pink, 1 green and 1 yellow box.



+4 NEW

91217

Basic Grammar Symbols

The basic grammar symbol box contains of 10 different symbols each represent a specific part of speech. The symbols are made of wood for durability. Using this Montessori aid helps children to sensorially enhance each part of speech. Made of high quality natural wood.



Montessori Products



+4 NEW

91221

Printed Alphabet Boxes

The Printed Alphabet is used for writing word sentences and stories. There are 20 of each plastic letter, which are printed in lower case on one side and upper case on the other side. Included 2 wooden boxes with lid.

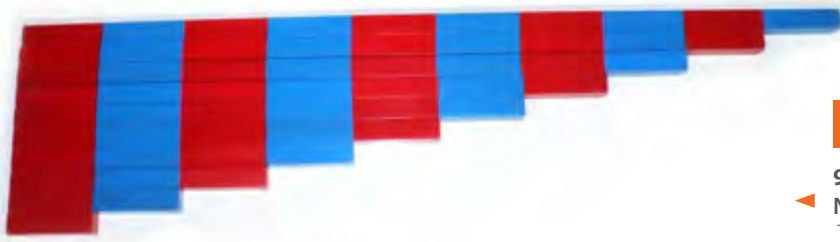

+4 NEW

91307

Number rods

Ten rods identical with the Red Rods in length, but divided into in an alternating red and blue pattern. They are varying in length from 10 centimeters to 1 meter. Ideal for introducing children to quantity.



Montessori
Products

+4 NEW

91301

Spindle box

The Spindle Box is a Montessori math material that introduce counting with wooden rods. children associate the corresponding quantities with the numerals. Also the concept of zero is introduced.



+4 NEW

91300

Numbers and counters

This Montessori material is used to help children understand the relation between symbol and quantity. 55 red wooden counters and 10 wooden cards with numbers printed on it from 1 -10. Comes in a wooden box. Made of high quality natural wood.

+5 NEW

91302

Wooden hundred squares ▶

This Montessori material can be used as an introduction for decimal system. Set of 45 silk-screened wooden squares in a wooden tray. Made of high quality natural wood.



Montessori
Products



+5 NEW

91303

◀ **Wooden Thousand Cubes**

This Montessori material can be used as an introduction for decimal system. Set of 9 silk-screened wooden cubes in a wooden tray. Made of high quality natural wood.

+5 NEW

91313

Large Numerals 1 - 9000 ▶

Set of large wooden tiles with printed numbers from 1-9000. It comes in different length and color according to the hierarches. Made of high quality natural wood.



+5 NEW

91314

◀ **Small Numerals 1 - 9000**

Set of small wooden tiles with printed numbers from 1-9000. It comes in different length and color according to the hierarches. Made of high quality natural wood.



+4 NEW

91304

◀ **Tens boards**

Two wooden boards divided to 5 equal sections. Numbers from 10 to 90 are printed on the boards and from 1 to 9 on wooden tiles.

+4 NEW

91305

Teen boards ▶

Two wooden boards divided to 5 equal sections. Number 10 is printed on the boards and numbers from 1 to 9 printed on wooden tiles.



Montessori
Products



+4 NEW

91315

◀ **Hundred Board with Wooden Tiles**

Wooden board divided to 100 squares, with wooden tiles with printed numbers on it from 1 -100. Comes with wooden box for tiles storage. Made of high quality natural wood.

+5 NEW

These Charts & Tiles set include working boards and a set of wooden tiles in lidded box. There are 4 products demonstrating addition, subtraction, multiplication and division.



91318
Addition Chart and Tiles



91319
Multiplication Charts and Tiles

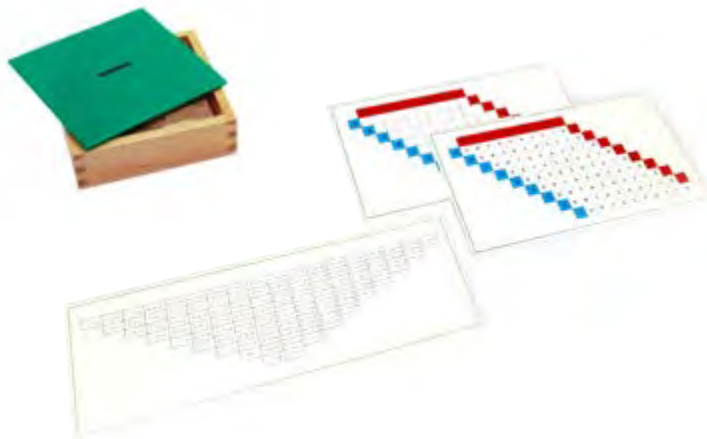

91320
Subtraction Charts and tiles



91321
Division Charts and Tiles



+4 NEW

91323

▶ **Addition Strip Board**

This Montessori material is used for learning addition in a concrete way. It consists of a wooden board, 9 red strips, 9 blue strips and a wooden box. Made of high quality natural wood.

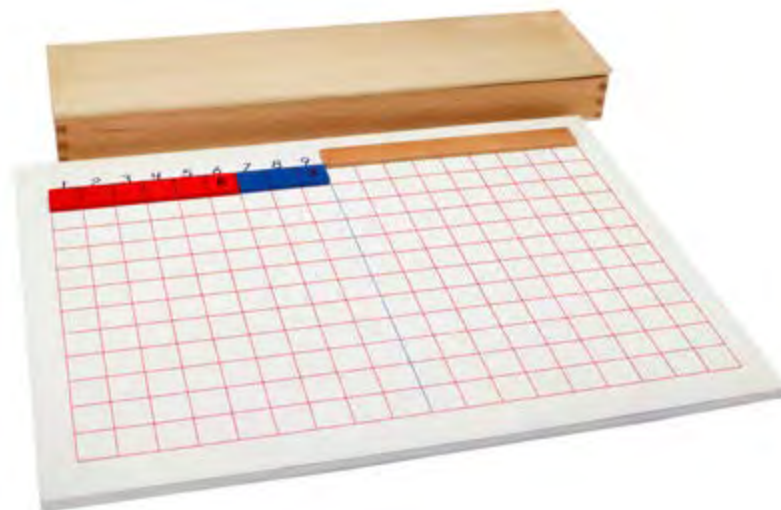

+4 NEW

91322

▶ **Subtraction Strip Board**

Ideal material for learning subtraction in a concrete way. It consists of a wooden board, 9 red strips, 9 blue strips, 17 wooden strips and a wooden box. Made of high quality natural wood.



Oriental Products

The oriental heritage is a magical world, full of interesting items that made it a subject for studying therefore the heritage has become an inspiration for designers which is shown in their designs. As children are the center of our attention therefore we have used the heritage in the educational process. We have designed toys with oriental style to express our ancient culture, through which children will discover the world around them and give them a chance to develop their Logical/mathematical intelligence, spatial intelligence, intrapersonal intelligence and interpersonal intelligence and expand their experiences.





+3

31340

The Palace Blocks ▼

Constructive blocks with oriental crafts, it includes 62 wooden blocks and a variety of characters, trees and animals, it gives the child the chance to create and imagine and at the same time introduce the child to team work and increase his/her self confidence. A great toy for enhancing interpersonal and bodily-kinesthetic intelligences.

Basic Block Module 4.6 cm



Oriental Products



+3

31345 ▼

Desert village

One of the constructive games that has the style of a desert village. Includes 48 wooden blocks and a variety of characters, trees and animals which the child can make a lot of constructions of the village. This helps the child in developing his ability to imagine and create. It also helps in developing fine motor skills which reinforce the bodily-kinesthetic intelligence. Helps Interpersonal intelligence to be developed when it is used with group of children.

Basic Block Module 4.6 cm



Oriental
Products

+1

31395 ▼

Nubian Blocks

Children in this age need something to grab their attention and develop their muscles. Therefore we have introduced these special cheerful colored blocks with there beautiful Nubian crafts, to give the child a chance to make a variety of designs. It develops the child's creative skills. Ideal for enhancing interpersonal and bodily-kinesthetic intelligences.

Basic Block Module 3.5 cm





A

A 11150 / Alaa Aldin & Camel
 B 11155 / Genie & Jewellery
 C 11160 / The Market
 D 11165 / Princess in her Palace



C



B



D

+4

One Thousand and One Nights Puzzle ▲

A set of interesting puzzles that are inspired from one thousand and one nights stories which the child enjoys playing with. It includes amazing colors and illustrations. The set includes 4 boards, each board consists of 2 layers, the lower layer is not colored, which makes it easy for the child to assemble. It develops fine motor skills and logical thinking helping the bodily-kinesthetic, linguistic and Logical-Mathematical intelligences to be promoted.

Size : 20 x 32.5 x 0.9 cm



Oriental Products



+3

31415

Camels' Caravan

While playing with the camel's caravan game the child lives in a world full of fantasy, in which the child imagines himself with camels in the desert. The toy includes 18 camels and 12 patterns divided as follows (6 shadows patterns- 6 colored patterns). It also includes a wooden stand to put the patterns on. The child tries to match the wooden pieces to the patterns according to their shapes and colors. It helps develop sorting and classifying skills plus introducing colors and geometrical shapes. Great for promoting Logical-Mathematical and linguistic intelligences.

Size : 33 x 18 x 4.7 cm



+4

30540 ▼

Ornaments Smart Board

An eastern style- smart board. Consists of 4 boards with geometrical shapes. Each board includes a table with a column and a row that are used as clues for pieces to be put in order on the board. This game develops sorting and classifying skills and introduces children to the concept of multiplication. It is a very important toy in developing logical/mathematical and spatial intelligences.

Size : 33 x 33 x 1 cm





+4

30530 ▲ Oriental Sky Memory

We have created this oriental styled memory game to develop the child's ability to concentrate helping Logical –Mathematical and Spatial intellegences to be promoted. The child spends his / her spare time in a game that is useful and entertaining. Great also for Interpersonal intelligence. The game includes 5 patterns. gre
28.5 x 28.5 x 3.3 cm



Themed Games



+4

31410 ▶ Balance Palm Tree

To develop the child ability to balance things, we have designed this wobbly palm tree. It introduces the child to team playing helping Interpersonal intellegnce to be enhanced. It consists of (3 bases,18 piece,3 palm trees, dice). The child tries to construct a palm tree with as many pieces and to keep the palm tree balanced. The game also develops persistence and concentration. All these skills help the Bodily/ kinesthetic and Logical /Mathematical intellegnces to develop
10 x 10 x 26 cm



+4

31420 ▶ Camel's Fun

An amazing game that develops creativity and imagination. The child tries to build a variety of vertical structures of camels in a balanced way. The game include 24 camels which come in 4 different colors and 2 different sizes .It develops fine motor skills while the child tries to balance the camels and also develops hand - eye coordination , logical thinking and problem solving . Perfect for promoting logical/ mathematical and bodily/kinesthetic intellegnces. Large Camel 5.7 x 4.7 cm / Small Camel 4.5 x 3.6 cm



Oriental Products

+5

31075 ▶ Ornaments Dominos

Children are mostly attracted to dominos; therefore we created new items for this game. A variety of geometrical crafts with cheerful colors that the child enjoys a lot. This game develops sorting skills and also the child ability to solve problems. All these skills are important to develop logical/Mathematical and Spatial intellegnces. A great toy for strengthen Interpersonal intellegnce.
24 x 9 x 4.7 cm



+6

31070 ▶ Fraction Domino

The fraction concept is one of the most difficult concepts for the child to learn.This is why we have created this dominos to simplify the concept so the child can spend his/her spare time in a useful and beneficial game. The child develops a vareity of concepts such as recognition of fractions. Ideal for developing logical/mathematical, spatial and Interpersonal intellegnce.
24 x 9 x 4.7 cm





Dramatic Play

Step into the world of a child's imagination, playing house, going shopping, having a tea party for a favorite teddy or acting as a doctor for an injured doll. Some children have *interpersonal intelligence* which means they are sensitive to others' moods, feelings, temperaments and motivations, and their ability to cooperate in order to work as part of a group. This section helps to enhance *interpersonal intelligence* for children who need, to break down walls of shyness and helps who have it already to excel with it, as they role-play different characters. Whatever the game of pretend they've conjured up we have the toys, kits, puppets and scaled down models which help their imagination to come alive.





Dramatic
Play

+3

21660

One Unit Pretend Kitchen ▶

Our little cute kitchen will inspire hours of imaginative play. It also develops important social skills such as sharing & communication.ideal for promoting Linguistic and intrapersonal intelligence. Suitable for small spaces in schools & Nurseries Includes: oven, washing machine, stove and fridge
Size : 40 x 112 x 105 cm



C 21616 Fridge



B 21601 Cooker



A 21606 Sink Washing Machine

Dramatic Play

+3

▲ Children Kitchen Play

Our kitchen set will make your home corner the most attractive in town! In this kitchen set we have combined play value with the highest quality, durability and of course, value for money. There are 3 units in this set: (Cooker - Fridge - Sink / Washing Machine -).All units are constructed from quality lacquered beech wood and laminated board which has a tough protective finish. It encourages children to create different dramatic situations that will help Linguistic and intrapersonal intelligence to be developed.



+3

43904













◀ Children's Lounge

The children's lounge is a great addition to a reception area, reading corner or cozy grouping. It is a very effective piece of furniture which encourages children to create different dramatic situations that will help Linguistic and intrapersonal intelligence to be developed. The sofa, chairs and table are made with quality beech wood frames. Supplied with colorful removable cushions.

Sofa / Chair Size : H 22 cm - Table Size : H 34 cm















Vegetables for Sale

 carrots	 lettuce	 mushrooms
PRICE \$	PRICE \$	PRICE \$
 corn	 capsicum	 broccoli
PRICE \$	PRICE \$	PRICE \$
 celery	 pumpkin	 eggplant
PRICE \$	PRICE \$	PRICE \$
 cauliflower	 tomato	 peas
PRICE \$	PRICE \$	PRICE \$

LVSP



Fruit for Sale

 pineapple	 blueberries	 bananas
PRICE \$	PRICE \$	PRICE \$
 orange	 raspberries	 apple
PRICE \$	PRICE \$	PRICE \$
 strawberries	 apricot	 grapes
PRICE \$	PRICE \$	PRICE \$
 cherries	 pears	 watermelon
PRICE \$	PRICE \$	PRICE \$

LFSP

+4

Role-play posters

Grocery, fruit and vegetables shopping role-play, is a great way for children to learn how to use money in real situations. Practicing giving change, adding and subtracting gives children life skills. Ideal for spatial and Linguistic intelligence development.



Groceries for Sale

 milk	 cream	 butter
PRICE \$	PRICE \$	PRICE \$
 yoghurt	 ice cream	 margarine
PRICE \$	PRICE \$	PRICE \$
 cheese	 eggs	 fish
PRICE \$	PRICE \$	PRICE \$
 steak	 chicken	 sausages
PRICE \$	PRICE \$	PRICE \$

LGSP

+4

871

Mr Chef

What is the menu today? An attractive board design that children can Print their menu and display it on. They can also write on it with markers. Encourages role play and pretending which help promote linguistic and intrapersonal intelligence.



Dramatic Play

+3

41315

Mini Work Shop ▶

This toolbox introduces the child to different carpentering tools. It contains 29 wooden pieces including a hammer, a spanner, and a screwdriver. Children can use one side of the box as a tool bench and the other side as a box to store tools and materials. This toy allows the child to have the most use of his imagination and improve his fine muscles which leads to Linguistic and intrapersonal intelligence to be developed.

Size : 26 x 13 x 14 cm



+2

21570

◀ **Fun Pretend Clothes Rack**

This ironing set has been specially designed to be true to life. Little ones adore role play and pretending and can keep them happy for hours. It can help developing Linguistic and intrapersonal intelligence. It comes with a wooden iron & ironing board that can be folded flat for storage.

Size : 55.3 x 34 x 55.3 cm



+2

21565

Fun Pretend Iron Set ▶

This ironing set has been specially designed to be true to life. Little ones adore role play and pretending and can keep them happy for hours. It can help developing Linguistic and intrapersonal intelligence. It comes with a wooden iron & ironing board that can be folded flat for storage.

Iron Size : 16.4 x 10.3 x 10 cm

Table Size : 82.5 x 28 x 55 cm





21560
Modern Theater
 Size : 91 x 35 x 167 cm

Theatres

Our attractive Theater invites your child to put on a show the audience will never forget. The wooden design features a sturdy, non-tip base to protect your child and the audience, and there is plenty of room inside for a puppeteer or two. These theatres allow the children to have the most use of his imagination which help Linguistic and intrapersonal intelligence to be developed



Dramatic
 Play



21555
Elegance Theater ▶
 Size : 68 x 40 x 136 cm

21500
Classic Theater
 Size : 94 x 33.5 x 137 cm

+3

Hand Puppets

Role play, dramatic play, imagination and the chance to develop speaking can all be obtained with this range of delightful and colourful puppets. Children will love these colourful and friendly animals and character made with colourful soft, safe fabrics. Perfect for Linguistic and Interpersonal intelligence development.



W318 ▶

W646 ▶



W721 ▶



W140 ▶



W722 ▶



W748 ▶



W292 ▶



W723 ▶



W141 ▶



W270 ▶



W588 ▶



W670 ▶



W123 ▶



W117 ▶

Dramatic Play



W742 ▶



W564 ▶



W563 ▶



W066 ▶



W193 ▶



W240 ▶



W195 ▶

+3

Animal Mask ▶

These masks are designed for everyday fun, great for dress up and pretend play. It's also an Ideal gift for young children. Perfect for themed birthday parties. Helps children develop Linguistic and Interpersonal intelligence.



Rabbit-38001 ▼

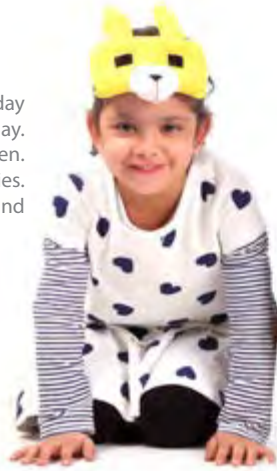

Elephant-38000 ▼



Dog-38002 ▼



Mask & Tail Set - 38005 ▼

Mouse ▼



Rabbit ▼



Elephant ▼



Giraffe ▼



Fox ▼



Cat ▼



Lion ▼

















Dramatic
Play





Poster

Our fun range of educational posters are reliable, durable and safe; which teachers and parents of children can use to teach math, science, language and literacy. We supply high quality and trusted educational posters to schools, nurseries and activity centers.

Colours Are Fun

red  apple	yellow  duck	blue  rabbit
green  frog	orange  fish	purple  octopus
pink  hippo	lime  caterpillar	brown  bear
grey  elephant	white  snowman	black  cat

Helping A...

 Make the bed	S M T W T F S
 Sweep the floor	S M T W T F S
 help make dinner	S M T W T F S
 Tidy room	S M T W T F S

Blending Consonants

br	br	cl
dr	fl	fr
gr	pl	pr
l	sc	sk
sn	sp	st
sh	kn	wh
h	ing	ell
ll	ack	ock

Single Sounds A

Aa apple	Bb bear	Cc crocodile
Ee elephant	Ff frog	Gg grapes
Ii itchy	Jj jellyfish	Kk kangaroo
Mm moose	Nn night	Oo octopus
Qq queen	Rr rabbit	Ss snail
Uu umbrella	Vv van	Ww whale
Yy yacht	Zz zoo	

Double Sounds Are Fun

ch chicken	sh shark	th 3 three	wh whale
ar car	ay crayons	oo balloons	oo book
ow cow	ow window	ee bee	ey monkey
er flower	ir bird	ur turtle	all ball
oa road	oi coin	ou mouse	ew screw
aw strawberry	au dinosaur	or horse	ear bear
ea seal	oa boat	ai train	air chair
a-e cake	i-e bike	o-e hose	igh night

Around the House

Help with laundry	A B C D E F G H I J K L M N O P Q R S T U V W X Y Z
Feed the pets	A B C D E F G H I J K L M N O P Q R S T U V W X Y Z
Set the table	A B C D E F G H I J K L M N O P Q R S T U V W X Y Z
Put away dishes	A B C D E F G H I J K L M N O P Q R S T U V W X Y Z

All About Time

bedtime
waking up
breakfast
lunch
going to school
morning tea

Special times

o'clock quarter past half past quarter to

From 12 Midnight to 12 Noon we write am, which means it is morning.
From 12 Noon to 12 Midnight we write pm, which means it is afternoon.

seconds = 1 minute
minutes = 1 hour
hours = 1 day
days = 1 week
weeks = 1 fortnight
weeks (and 1 day), 365 days = 1 year
4 days = 1 leap year
months = 1 year
years = 1 decade
100 years = 1 century
1000 years = 1 millennium

JANUARY
FEBRUARY
MARCH
APRIL
MAY
JUNE
JULY
AUGUST
SEPTEMBER
OCTOBER
NOVEMBER
DECEMBER

Thirty days has September,
April, June and November,
All the rest have thirty-one,
Excepting February alone,
Which has twenty-eight days clean,
And twenty-nine in a leap year.

Educational Posters



Single Sounds Are Fun

Aa	Bb	Cc	Dd
Ee	Ff	Gg	Hh
Ii	Jj	Kk	Ll
Mm	Nn	Oo	Pp
Qq	Rr	Ss	Tt
Uu	Vv	Ww	Xx
Yy	Zz		

Blending Consonants Are Fun

bl	br	cl	cr
dr	fl	fr	gl
gr	pl	pr	tr
sl	sc	sk	sm
sn	sp	st	sw
sh	kn	wh	le
and	ing	ell	ill
oll	ack	ock	uck

Double Sounds Are Fun

ch	sh	th	wh
ar	ay	oo	oo
ow	ow	ee	ey
er	ir	ur	all
oa	oi	ou	ew
aw	au	or	ear
ea	oa	ai	air
a-e	i-e	o-e	igh



LABCN

LBLPN

LDSPN

Helping Around the House

Makes the bed	Help with laundry
Sweep the floor	Feed the pets
Help make dinner	Set the table
Tidy room	Put away dishes

LHAFP

Colours Are Fun

red	yellow	blue
green	orange	purple
pink	lime	brown
grey	white	black

LCAFP

All About Time







Special times

- 12 noon
- 12 midnight
- 1:00
- 2:00
- 3:00
- 4:00
- 5:00
- 6:00
- 7:00
- 8:00
- 9:00
- 10:00
- 11:00
- 12:00

LAATP

Educational Posters

Let's Count to 10

1		one
2		two
3		three
4		four
5		five
6		six
7		seven
8		eight
9		nine
10		ten

LTEN

Numbers Are Fun

0	1	2
3	4	5
6	7	8
9	10	11
12	13	14
15	16	17
18	19	20



LNAFPN

Counting is Fun

0	1	2	3	4	5	6	7	8	9
10	11	12	13	14	15	16	17	18	19
20	21	22	23	24	25	26	27	28	29
30	31	32	33	34	35	36	37	38	39
40	41	42	43	44	45	46	47	48	49
50	51	52	53	54	55	56	57	58	59
60	61	62	63	64	65	66	67	68	69
70	71	72	73	74	75	76	77	78	79
80	81	82	83	84	85	86	87	88	89
90	91	92	93	94	95	96	97	98	99

LCIFP

Educational Posters

Division is Fun

÷ by 1		÷ by 2		÷ by 3		÷ by 4		÷ by 5		÷ by 6	
1÷1=1	2÷1=2	3÷1=3	4÷1=4	5÷1=5	6÷1=6	7÷1=7	8÷1=8	9÷1=9	10÷1=10	11÷1=11	12÷1=12
2÷2=1	4÷2=2	6÷2=3	8÷2=4	10÷2=5	12÷2=6	14÷2=7	16÷2=8	18÷2=9	20÷2=10	22÷2=11	24÷2=12
3÷3=1	6÷3=2	9÷3=3	12÷3=4	15÷3=5	18÷3=6	21÷3=7	24÷3=8	27÷3=9	30÷3=10	33÷3=11	36÷3=12
4÷4=1	8÷4=2	12÷4=3	16÷4=4	20÷4=5	24÷4=6	28÷4=7	32÷4=8	36÷4=9	40÷4=10	44÷4=11	48÷4=12
5÷5=1	10÷5=2	15÷5=3	20÷5=4	25÷5=5	30÷5=6	35÷5=7	40÷5=8	45÷5=9	50÷5=10	55÷5=11	60÷5=12
6÷6=1	12÷6=2	18÷6=3	24÷6=4	30÷6=5	36÷6=6	42÷6=7	48÷6=8	54÷6=9	60÷6=10	66÷6=11	72÷6=12
7÷7=1	14÷7=2	21÷7=3	28÷7=4	35÷7=5	42÷7=6	49÷7=7	56÷7=8	63÷7=9	70÷7=10	77÷7=11	84÷7=12
8÷8=1	16÷8=2	24÷8=3	32÷8=4	40÷8=5	48÷8=6	56÷8=7	64÷8=8	72÷8=9	80÷8=10	88÷8=11	96÷8=12
9÷9=1	18÷9=2	27÷9=3	36÷9=4	45÷9=5	54÷9=6	63÷9=7	72÷9=8	81÷9=9	90÷9=10	99÷9=11	108÷9=12
10÷10=1	20÷10=2	30÷10=3	40÷10=4	50÷10=5	60÷10=6	70÷10=7	80÷10=8	90÷10=9	100÷10=10	110÷10=11	120÷10=12
11÷11=1	22÷11=2	33÷11=3	44÷11=4	55÷11=5	66÷11=6	77÷11=7	88÷11=8	99÷11=9	110÷11=10	121÷11=11	132÷11=12
12÷12=1	24÷12=2	36÷12=3	48÷12=4	60÷12=5	72÷12=6	84÷12=7	96÷12=8	108÷12=9	120÷12=10	132÷12=11	144÷12=12
13÷13=1	26÷13=2	39÷13=3	52÷13=4	65÷13=5	78÷13=6	91÷13=7	104÷13=8	117÷13=9	130÷13=10	143÷13=11	156÷13=12
14÷14=1	28÷14=2	42÷14=3	56÷14=4	70÷14=5	84÷14=6	98÷14=7	112÷14=8	126÷14=9	140÷14=10	154÷14=11	168÷14=12
15÷15=1	30÷15=2	45÷15=3	60÷15=4	75÷15=5	90÷15=6	105÷15=7	120÷15=8	135÷15=9	150÷15=10	165÷15=11	180÷15=12
16÷16=1	32÷16=2	48÷16=3	64÷16=4	80÷16=5	96÷16=6	112÷16=7	128÷16=8	144÷16=9	160÷16=10	176÷16=11	192÷16=12
17÷17=1	34÷17=2	51÷17=3	68÷17=4	85÷17=5	102÷17=6	119÷17=7	136÷17=8	153÷17=9	170÷17=10	187÷17=11	204÷17=12
18÷18=1	36÷18=2	54÷18=3	72÷18=4	90÷18=5	108÷18=6	126÷18=7	144÷18=8	162÷18=9	180÷18=10	198÷18=11	216÷18=12
19÷19=1	38÷19=2	57÷19=3	76÷19=4	95÷19=5	114÷19=6	133÷19=7	152÷19=8	171÷19=9	190÷19=10	209÷19=11	228÷19=12
20÷20=1	40÷20=2	60÷20=3	80÷20=4	100÷20=5	120÷20=6	140÷20=7	160÷20=8	180÷20=9	200÷20=10	220÷20=11	240÷20=12
21÷21=1	42÷21=2	63÷21=3	84÷21=4	105÷21=5	126÷21=6	147÷21=7	168÷21=8	189÷21=9	210÷21=10	231÷21=11	252÷21=12
22÷22=1	44÷22=2	66÷22=3	88÷22=4	110÷22=5	132÷22=6	154÷22=7	176÷22=8	198÷22=9	220÷22=10	242÷22=11	264÷22=12
23÷23=1	46÷23=2	69÷23=3	92÷23=4	115÷23=5	138÷23=6	161÷23=7	184÷23=8	207÷23=9	230÷23=10	253÷23=11	276÷23=12
24÷24=1	48÷24=2	72÷24=3	96÷24=4	120÷24=5	144÷24=6	168÷24=7	192÷24=8	216÷24=9	240÷24=10	264÷24=11	288÷24=12
25÷25=1	50÷25=2	75÷25=3	100÷25=4	125÷25=5	150÷25=6	175÷25=7	200÷25=8	225÷25=9	250÷25=10	275÷25=11	300÷25=12
26÷26=1	52÷26=2	78÷26=3	104÷26=4	130÷26=5	156÷26=6	182÷26=7	208÷26=8	234÷26=9	260÷26=10	286÷26=11	312÷26=12
27÷27=1	54÷27=2	81÷27=3	108÷27=4	135÷27=5	162÷27=6	189÷27=7	216÷27=8	243÷27=9	270÷27=10	297÷27=11	324÷27=12
28÷28=1	56÷28=2	84÷28=3	112÷28=4	140÷28=5	168÷28=6	196÷28=7	224÷28=8	252÷28=9	280÷28=10	308÷28=11	336÷28=12
29÷29=1	58÷29=2	87÷29=3	116÷29=4	145÷29=5	174÷29=6	203÷29=7	232÷29=8	261÷29=9	290÷29=10	319÷29=11	348÷29=12
30÷30=1	60÷30=2	90÷30=3	120÷30=4	150÷30=5	180÷30=6	210÷30=7	240÷30=8	270÷30=9	300÷30=10	330÷30=11	360÷30=12
31÷31=1	62÷31=2	93÷31=3	124÷31=4	155÷31=5	186÷31=6	217÷31=7	246÷31=8	275÷31=9	306÷31=10	337÷31=11	372÷31=12
32÷32=1	64÷32=2	96÷32=3	128÷32=4	160÷32=5	192÷32=6	224÷32=7	256÷32=8	288÷32=9	320÷32=10	352÷32=11	384÷32=12
33÷33=1	66÷33=2	99÷33=3	132÷33=4	165÷33=5	198÷33=6	231÷33=7	264÷33=8	297÷33=9	330÷33=10	363÷33=11	396÷33=12
34÷34=1	68÷34=2	102÷34=3	136÷34=4	170÷34=5	204÷34=6	238÷34=7	272÷34=8	306÷34=9	340÷34=10	374÷34=11	408÷34=12
35÷35=1	70÷35=2	105÷35=3	140÷35=4	175÷35=5	210÷35=6	245÷35=7	280÷35=8	315÷35=9	350÷35=10	385÷35=11	420÷35=12
36÷36=1	72÷36=2	108÷36=3	144÷36=4	180÷36=5	216÷36=6	252÷36=7	288÷36=8	324÷36=9	360÷36=10	396÷36=11	432÷36=12
37÷37=1	74÷37=2	111÷37=3	148÷37=4	185÷37=5	222÷37=6	259÷37=7	296÷37=8	333÷37=9	370÷37=10	407÷37=11	444÷37=12
38÷38=1	76÷38=2	114÷38=3	152÷38=4	190÷38=5	228÷38=6	266÷38=7	304÷38=8	342÷38=9	380÷38=10	414÷38=11	456÷38=12
39÷39=1	78÷39=2	117÷39=3	156÷39=4	195÷39=5	234÷39=6	273÷39=7	312÷39=8	351÷39=9	390÷39=10	423÷39=11	468÷39=12
40÷40=1	80÷40=2	120÷40=3	160÷40=4	200÷40=5	240÷40=6	280÷40=7	320÷40=8	360÷40=9	400÷40=10	440÷40=11	480÷40=12
41÷41=1	82÷41=2	123÷41=3	164÷41=4	205÷41=5	246÷41=6	287÷41=7	326÷41=8	367÷41=9	410÷41=10	447÷41=11	486÷41=12
42÷42=1	84÷42=2	126÷42=3	168÷42=4	210÷42=5	252÷42=6	294÷42=7	334÷42=8	376÷42=9	420÷42=10	454÷42=11	498÷42=12
43÷43=1	86÷43=2	129÷43=3	172÷43=4	215÷43=5	258÷43=6	301÷43=7	342÷43=8	385÷43=9	430÷43=10	461÷43=11	510÷43=12
44÷44=1	88÷44=2	132÷44=3	176÷44=4	220÷44=5	264÷44=6	308÷44=7	350÷44=8	394÷44=9	440÷44=10	468÷44=11	522÷44=12
45÷45=1	90÷45=2	135÷45=3	180÷45=4	225÷45=5	270÷45=6	315÷45=7	358÷45=8	403÷45=9	450÷45=10	475÷45=11	534÷45=12
46÷46=1	92÷46=2	138÷46=3	184÷46=4	230÷46=5	276÷46=6	322÷46=7	366÷46=8	412÷46=9	460÷46=10	482÷46=11	546÷46=12
47÷47=1	94÷47=2	141÷47=3	188÷47=4	235÷47=5	282÷47=6	329÷47=7	374÷47=8	421÷47=9	470÷47=10	489÷47=11	558÷47=12
48÷48=1	96÷48=2	144÷48=3	192÷48=4	240÷48=5	288÷48=6	336÷48=7	382÷48=8	430÷48=9	480÷48=10	496÷48=11	570÷48=12
49÷49=1	98÷49=2	147÷49=3	196÷49=4	245÷49=5	294÷49=6	343÷49=7	390÷49=8	439÷49=9	490÷49=10	503÷49=11	582÷49=12
50÷50=1	100÷50=2	150÷50=3	200÷50=4	250÷50=5	300÷50=6	350÷50=7	400÷50=8	450÷50=9	500÷50=10	550÷50=11	600÷50=12
51÷51=1	102÷51=2	153÷51=3	204÷51=4	255÷51=5	306÷51=6	357÷51=7	406÷51=8	459÷51=9	510÷51=10	561÷51=11	612÷51=12
52÷52=1	104÷52=2	156÷52=3	208÷52=4	260÷52=5	312÷52=6	364÷52=7	414÷52=8	468÷52=9	520÷52=10	572÷52=11	624÷52=12
53÷53=1	106÷53=2	159÷53=3	212÷53=4	265÷53=5	318÷53=6	371÷53=7	422÷53=8	477÷53=9	530÷53=10	583÷53=11	636÷53=12
54÷54=1	108÷54=2	162÷54=3	216÷54=4	270÷54=5	324÷54=6	378÷54=7	430÷54=8	486÷54=9	540÷54=10	594÷54=11	648÷54=12
55÷55=1	110÷55=2	165÷55=3	220÷55=4	275÷55=5	330÷55=6	385÷55=7	438÷55=8	495÷55=9	550÷55=10	603÷55=11	660÷55=12
56÷56=1	112÷56=2	168÷56=3	224÷56=4	280÷56=5	336÷56=6	392÷56=7	446÷56=8	504÷56=9	560÷56=10	612÷56=11	672÷56=12
57÷57=1	114÷57=2	171÷57=3	228÷57=4	285÷57=5	342÷57=6	400÷57=7	454÷57=8	513÷57=9	570÷57=10	621÷57=11	684÷57=12
58÷58=1	116÷58=2	174÷58=3	232÷58=4	290÷58=5	348÷58=6	407÷58=7	462÷58=8	522÷58=9	580÷58=10	630÷58=11	696÷58=12
59÷59=1	118÷59=2	177÷59=3	236÷59=4	295÷59=5	354÷59=6	415÷59=7	470÷59=8	531÷59=9	590÷59=10	639÷59=11	708÷59=12
60÷60=1	120÷60=2	180÷60=3	240÷60=4	300÷60=5	360÷60=6	420÷60=7	478÷60=8	540÷60=9	600÷60=10	648÷60=11	720÷60=12
61÷61=1	122÷61=2	183÷61=3	244÷61=4	305÷61=5	366÷61=6	427÷61=7	486÷61=8	549÷61=9	610÷61=10	657÷61=11	732÷61=12
62÷62=1	124÷62=2	186÷62=3	248÷62=4	310÷62=5	372÷62=6	434÷62=7	494÷62=8	558÷62=9	620÷62=10	666÷62=11	744÷62=12
63÷63=1	126÷63=2	189÷63=3	252÷63=4	315÷63=5	378÷63=6	441÷63=7	502÷63=8	567÷63=9	630÷63=10	675÷63=11	756÷63=12
64÷64=1	128÷64=2	192÷64=3	256÷64=4	320÷64=5	384÷64=6	448÷64=7	510÷64=8	576÷64=9	640÷64=10	684÷64=11	768÷64=12
65÷65=1	130÷65=2	195÷65=3	260÷65=4	325÷65=5	390÷65=6	455÷65=7	518÷65=8	585÷65=9	650÷65=10	693÷65=11	780÷65=12
66÷66=1	132÷66=2	198÷66=3	264÷66=4	330÷66=5	396÷66=6	462÷66=7	526÷66=8	594÷66=9	660÷66=10	702÷66=11	792÷66=12
67÷67=1	134÷67=2	201÷67=3	268÷67=4</								

NEW
ABC

Fruit for Sale

pineapple PRICE \$	blueberries PRICE \$	bananas PRICE \$
orange PRICE \$	raspberries PRICE \$	apple PRICE \$
strawberries PRICE \$	apricot PRICE \$	grapes PRICE \$
cherries PRICE \$	pears PRICE \$	watermelon PRICE \$

LFSP

Vegetables for Sale

carrots PRICE \$	lettuce PRICE \$	mushrooms PRICE \$
corn PRICE \$	capsicum PRICE \$	broccoli PRICE \$
celery PRICE \$	pumpkin PRICE \$	eggplant PRICE \$
cauliflower PRICE \$	tomato PRICE \$	peas PRICE \$

LVSP



Groceries for Sale

milk PRICE \$	cream PRICE \$	butter PRICE \$
yoghurt PRICE \$	ice cream PRICE \$	margarine PRICE \$
cheese PRICE \$	eggs PRICE \$	fish PRICE \$
steak PRICE \$	chicken PRICE \$	sausages PRICE \$

LGSP

Birthdays Are Fun

January 	February <input type="text"/>	March
April <input type="text"/>	May 	June <input type="text"/>
July 	August <input type="text"/>	September
October <input type="text"/>	November 	December <input type="text"/>

LBP

Edacational Posters



LEP

LMBP

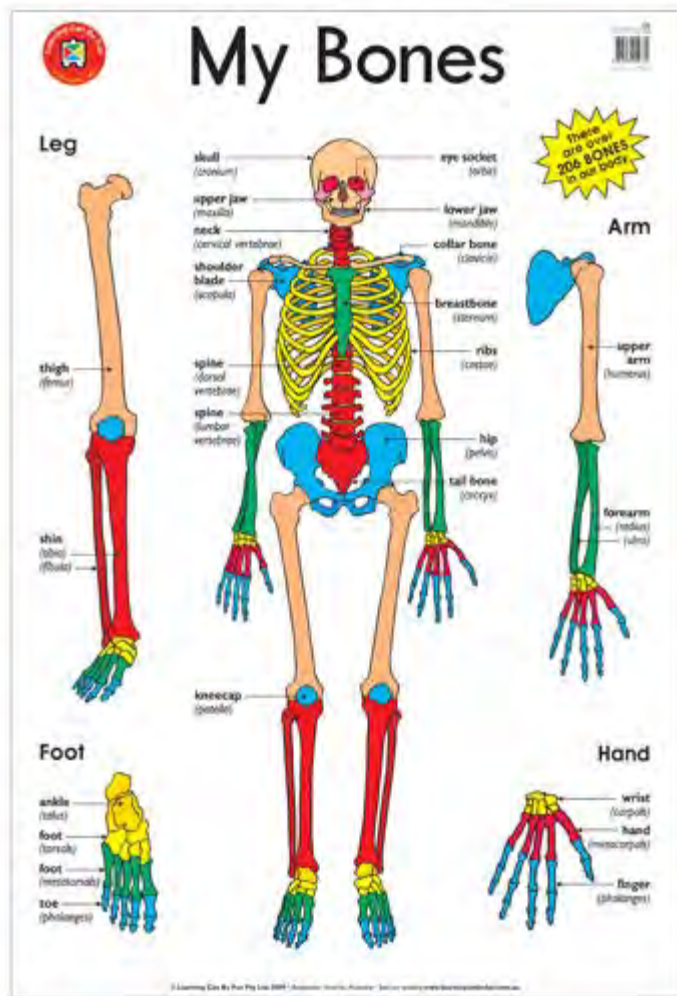

LMPN

Educational Posters



Educational Carpets

Our goal is to provide teachers, educators and parents with colorful, patterned theme area carpets to enhance learning for young children. We offer a wide selection of eco-friendly, educational carpets and interactive play rugs. Explore our selection of children's learning carpets to find the perfect play rug which will help you to sustain the multiple intelligences in children. Ideal for your classroom, library or home.





Educational
Carpets



▲ ALPHABET
CPR 607 - 130cm X 200cm



▲ ALPHABET GRID
CPR 543 - RECT. SMALL - 180 cm x 257 cm
CPR 545 - RECT. LARGE - 257cm x 360 cm



▲ MOON & STARS
CPR 524 - ROUND SMALL - 200cm
CPR 525 - ROUND LARGE - 275cm



▲ ABC SQUARES
CPR483 - ROUND SMALL - 200cm
CPR484 - ROUND LARGE - 275cm



▲ PENCILS ABC
CPR 422 - OVAL / SMALL: 198cm x 287cm
CPR 423 - OVAL / LARGE: 264cm x 365cm



▲ LET'S LEARN THE ALPHABET
CPR 939 - ROUND LARGE - 275 cm
CPR 938 - ROUND SMALL - 200cm



▲ **COLORFUL ABC**
 CPR 934 - ROUND SMALL - 200 cm
 CPR 935 - ROUND LARGE - 275 cm



▲ **TREE & APPLES ALPHABET**
 CPR 899 - RECT SMALL - 180cm x 257cm
 CPR 900 - REC LARGE - 257cm x 360 cm
 CPR 895 - OVAL SMALL - 198cm x 287cm
 CPR 896 - OVAL LARGE - 264cm x 365cm
 CPR 897 - ROUND SMALL - 200cm
 CPR 898 - ROUND LARGE - 275cm



▲ **ABC ROTARY**
 CPR 459 - RECT. SMALL - 180cm x 257cm
 CPR 460 - RECT. LARGE USD - 257cm x 360cm



▲ **CARS ALPHABET & NUMBERS**
 CPR 887 - RECT SMALL - 180cm x 257cm
 CPR 902 - REC LARGE - 257cm x 360 cm
 CPR 884 - OVAL SMALL - 198cm x 287cm
 CPR 885 - OVAL LARGE - 264cm x 365cm
 CPR 886 - ROUND SMALL - 200cm
 CPR 888 - ROUND LARGE - 275cm



▲ **ABC ROTARY**
 CPR 457 - ROUND SMALL - 200cm
 CPR 458 - ROUND LARGE - 275cm



▲ **ABC ROTARY**
 CPR 461 - OVAL SMALL - 198cm x 287cm
 CPR 462 - OVAL LARGE - 264cm x 365cm



▲ CATERPILLAR (3X2M)



▲ BIRDS, EGGS & ABC'S
CPR 893 - RECT SMALL - 180cm x 257cm
CPR 894 - REC LARGE - 257cm x 360 cm



▲ ABC Carpet
93410 - 200 x 250 Cm



▲ Healthy Foods Carpet
CPR 738 - 257cm X 360cm



▲ ARABIC ALPHABET PENCILS
CPR 815 - REC SMALL - 180cm X 257cm
CPR 816 - REC LARGE - 257cm x 360cm



▲ ARABIC ALPHABET
CPR 729 - RECTANGLE SMALL - 180cm x 257cm
CPR 730 - RECTANGLE LARGE - 257cm x 360cm



▲ Arabic alphabet Carpet
93411 - 200 x 250 Cm

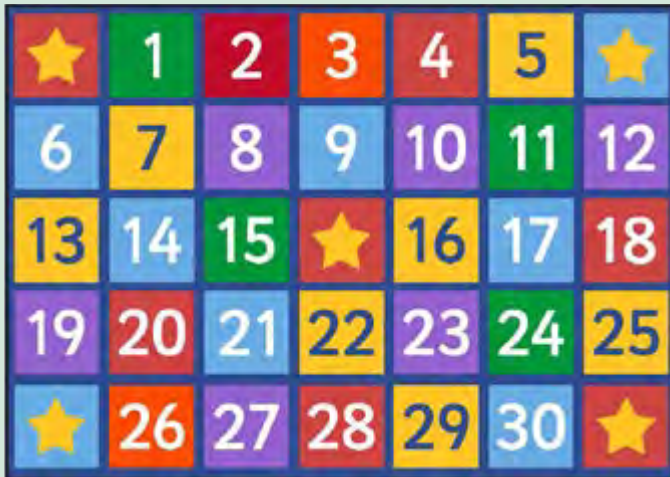

▲ NUMBERS 1-30
CPR 739 - 257cm X 360cm



▲ COUNTING RUG (number 1-12)
CPR 861 - RECT. SMALL - 180cm x 257cm
CPR 862 - RECT. LARGE - 257cm x 360cm



▲ JUMBO LARGE HOPSCOTCH
CPR 748 - 80cm X 3m



▲ 1-100 COUNTING (2X2M)



▲ MINI BEASTS (3X3M)



▲ WILD ANIMALS (3X3M)

Educational Carpets



▲ Mini Beasts (3X2M)



▲ **GEOMETRIC SHAPES:**
 CPR 408 - REC SMALL - 180cm x 257cm
 CPR 409 - REC LARGE - 257cm x 360cm



▲ **BUILDING BLOCKS**
 CPR 504 - 130 CM X 200 CM



▲ **GEOMETRIC SHAPES WEDGE CARPET**
 CPR 503 - 183cm



▲ **GEOMETRIC SHAPES:**
 CPR 406 - ROUND SMALL - 200cm
 CPR 407 - ROUND LARGE - 275cm



▲ **GEOMETRIC SHAPES (3X3M)**



▲ **EMOTIONS (2M DIAMETER)**

Educational
 Carpets



▲ COLOURWHEEL (2M DIAMETER)



▲ ABC PUZZLE:
CPR 452 - OVAL SMALL: 198cm x 287cm
CPR 453 - OVAL LARGE: 264cm x 365cm



▲ FISH & FROG GATHERING
CPR 932 - ROUND SMALL - 200cm
CPR 933 - ROUND LARGE - 275 cm

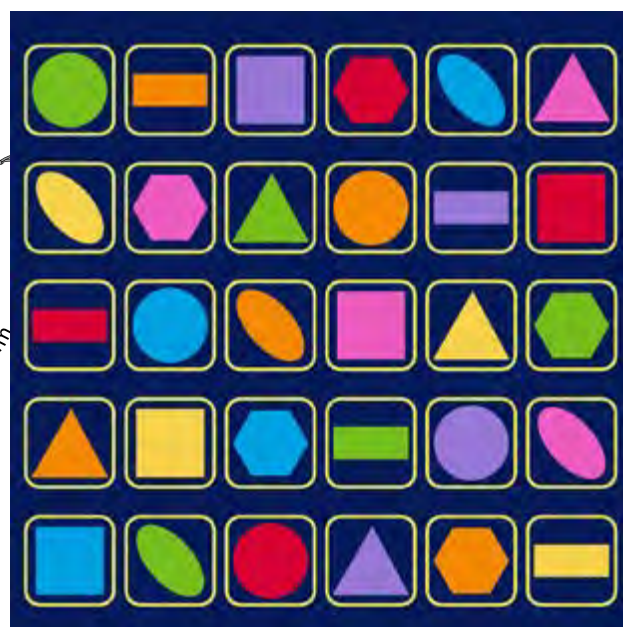

▲ Geometric Grid (3X3M)



▲ Story Telling (3X3M)



Educational
Carpets



Energetic Play

Children are a bundle of energy which needs the right toys to be exploited. We believe that the development of body and mind is essential for building the confidence that children will depend on throughout life. Therefore we have these wide ranges of energetic toys which help in developing Bodily-kinesthetic and Interpersonal intelligences.





Energetic
play

+4

2260

Robo Board ▶

The Robo-Board trains weight transfer, dynamic balance and provide proprioceptive stimulation for children from 4 years. The Robo-Board moves easily by means of the child's weight transfer from side to side. When the child's weight is shifted to one side using muscular force and rotation around the spinal column, the child can rotate in a circular movement of up to 360 degrees. The Robo-Board can be used to help children from four years to improve their muscle coordination, body consciousness, quality of movement and sense of flow, rhythm and regulation of force in their legs which all helps in developing bodily/kinesthetic intelligence. The experienced user can get

Robo-Board spinning and dancing – and can do tricks with it.



+2

2169 2

SEESAW ▶

Classic play equipment in a unique new design. Pliable synthetic rubber domes on the underside of the seesaw provide a softer, more dynamic movement. Helps children to balance which develops bodily/kinesthetic intelligence. The seesaw has a non-slip surface. The base of the pivot is covered with synthetic rubber to reduce the risk of crushing and to prevent damage to the floor.



+4 - 7

2195

Mini Stilts ▶

Unique stilts especially developed for younger children. The hard rubber handles provide a good grip that can be adapted to the height of the child.

Depending on how brave the child is, the child can adjust the height of the stilts using the loose plateaux (from 3 cm to 15 cm). Helps children to balance which develops bodily/kinesthetic intelligence. Even small children are able easily and safely to mount or remove the plateaux. The handles allow an older child or an adult to help younger children who have not yet mastered the stilts on their own. Made of plastic base with sole and handle of artificial rubber. The four plateaux are made of plastic.

Maximum load 100 kg.



+4

2266

Roller ▶

The Roller is a beautiful new conceptualization of a fundamentally challenging motor activity object. Leave it out, and you will see both children and grown-ups tempted to test their skills by stepping up and trying to set the Roller in motion. It offers a progressive motor skills challenge, from small kids just managing to keep

their balance with the support of a friend or a hand rail, to older children pushing the boundaries of what they can do without falling off. Whether it is used for play or in therapy, the Roller will stimulate the primary proprioceptive sense, as well as the vestibular and tactile senses promoting bodily/kinesthetic intelligence. The Roller is safe to use, as the compression of its rubber tyres naturally reduces the speed while making play virtually silent and protecting the ground surface from damage. This is combined with a rubber tread which provides a safe grip and offers additional tactile stimulation when rolling with bare feet.



Energetic
play

+ 1½

2190

ACTIVITY RINGS ▶

New, brightly coloured activity rings that appeal to children of all ages – and to adults. Activity Rings can be used as inspiration for countless activities such as dancing in a circle, walking on tiptoe in the rings, balancing the rings on your head, juggling rings on arms and legs, throwing rings to each other, jumping with rings around your legs, building figures – the combinations are limitless enhancing bodily/kinesthetic intelligence. The rings can be used in both spontaneous and structured activities during play, rhythmic and gymnastics which help interpersonal intelligence to enhance. Suitable for individual as well as social activities.

The Activity Rings are made of soft artificial rubber.



761

Elastics Ropes ▶

8 elastics of 3m long. Use them for high jumps or long jumps. Helps children to develop gross motor skills which promote bodily/kinesthetic intelligence.



+4 -10

2229

Build and Balance (Starter Set) ▶

Exciting and challenging balancing system. The elements can be combined in countless ways so use your imagination to set up all the balance courses and landscapes you can build.

With the great flexibility of Build N' Balance®, the level of difficulty can be varied to suit the development levels of the children and can be built at heights ranging from 10 to 24 cm –depending on how brave the children are! Develops balancing, co-ordination and large motor skills which promote bodily/kinesthetic intelligence. This set includes 3 Top10,3 Top24, 3 Planks, 2 Log Planks, 1 Rocking Plank and 1 Tilting Disc.



+2 -10

2238

◀ **Build N' Balance (Advanced Set)**

Exciting and challenging balancing system. The elements can be combined in countless ways so use your imagination to set up all the balance courses and landscapes you can build.

With the great flexibility of Build N' Balance®, the level of difficulty can be varied to suit the development levels of the children and can be built at heights ranging from 10 to 24 cm –depending on how brave the children are! Develops balancing, co-ordination and large motor skills which promote bodily/kinesthetic intelligence. This set includes 6 Top10,2 Top24, 3 Planks, 3 Log Planks, 2 Bridge Piers, 1 Slack Line, 1 Rocking Plank, 1 Bars & Joints, 1 Tilting Disc.



Energetic
play



Energetic Play



+4

Soft Rocking Items

Attractive soft rocking items that gives children a fun time.



Convertible Foam Element - 0237
120 x 60 x 30 cm



Car Foam Element - 0234
120 x 120 x 190 cm



Dragon Foam Element - 0236
120 x 80 x 160 cm



Doggy Foal Element - 0235
62 x 51 x 30 cm

Energetic
play



1897

◀ **Emotions Pouf**

6 pieces (each featuring a different emotion). Ideal for representing children to different feelings which develop bodily/kinesthetic Intrapersonal intelligence. Size: 120x120x190



2301

Parachute ▶

Playing with the parachute provides exercise for the whole body – for everyone!

A wonderful way of developing basic physical coordination helping bodily/kinesthetic intelligence to develop. Inspires many types of activities for groups of children or grown-ups which help interpersonal intelligence to enhance. Made of colourful, lightweight, fire-resistant polyester. Very strong handles. The parachutes have a strong 10 mm thick rope sewn into the outer edge, allowing an almost unlimited number of people to play at the same time. Maximum load 10 kg.



Energetic
play

Scooter, small ▶

Mastering a scooter gives children a tremendous sense of achievement and confidence. It is no wonder the wheels of the scooter never stop turning as long as there are children on the playground. It helps bodily/kinesthetic and interpersonal intelligence to be developed.



▲ Bicycle

Once children have mastered the two wheeler, they have reached another milestone in the development of their motor skills and thus the development of their bodily/kinesthetic intelligence. Their legs, arms, eyes and brain have to work together to keep their balance. This may sound difficult, but it's actually child's play. As long as they have the right things to play with.



+4 - 7

▼ 474.10

Bike Runner

The ideal play vehicle for children not yet ready for a scooter or bicycle. Provides a fun way of developing a good sense of balance helping bodily/kinesthetic intelligence to be enhanced.





+4 - 7

468

◀ Twin Taxi

Children often use play to imitate adults or situations they have experienced in their day-to-day lives. This kind of play activity is often called role-playing. The Twin Taxi stimulates the imagination – the possibilities are endless. Has room for three children which helps the intrapersonal intelligence to be developed. When children ride this twin, they train gross motor skills which help bodily/kinesthetic intelligence to be enhanced.



+4 - 7

465

Ben Hur tricycle ▶

This tricycle makes it easy for more children to play together at once which leads the intrapersonal intelligence to be developed. It helps stimulating their imaginations without compromising safety and it helps bodily/kinesthetic intelligence to be developed. Passengers standing up can hold on to the safety bar. As always, attaching a trailer can make it even more fun to play with.



+4 - 7

493

◀ Truck

It's time to get down to work. Sand and playground equipment is moved around effortlessly on this sturdy and well-designed bike. It provides children with ample opportunity for social role-play, and stimulates imagination, motor abilities, and reflexes. It helps bodily/kinesthetic and intrapersonal intelligence to be developed.



**Energetic
play**



+4 - 6

620

Foot Twister ▶

Foot Twister is a fun, challenging, and innovative vehicle that is propelled forward by the zigzag motion of eager children's feet.

To get a smooth ride it takes equal amounts of rhythm, technique and upper-body coordination. It is a challenge but most of all it is great fun. Perfect for bodily/kinesthetic intelligence improvement.



+4 - 7

498

◀ **FunCart**

Cool driving characteristics making it exciting to ride. Gives lots of fun with thrills and stimulation. Steering of the FunCart goes very smooth by using the two handle pins making the rear wheels move. Improves children's coordination skills as the child uses the entire body when driving leading the bodily/kinesthetic intelligence to be developed.



+4 - 7

496

Viking Kangaroo ▶

With this fun trike the child can bring out deliveries in the form of sand, toys, – anything really – to friends all over the playground encouraging children to be more social which enhances intrapersonal intelligence. The trike has a striking resemblance with a cargo bike and unlike the traditional delivery bike it has a real box in front – and not just a step plate. Load capacity 50 kg in the carrier box and 50 kg on the seat. Perfect for developing bodily/kinesthetic intelligence.



+ 2 - 4

550

Tricycle small ▶

The classic tricycle in a brand new design. Every child loves the freedom to get around on this trike. It is easy to move forward, trains the muscles and develops motor skills helping children promote their bodily/kinesthetic intelligence



+ 3 - 6

551

▶ **Tricycle, medium**

A very popular, robust tricycle suitable for most children. A tricycle is a must on every playground. It stimulates the play of children and develops children's motor skills. Ideal for bodily/kinesthetic intelligence development.



+ 4 - 8

552

▶ **Tricycle, large**

This tricycle is designed with a large front wheel enabling children up to 8 years of age to have fun on the playground. The keen children will love to drive around on this trike. Perfect for bodily/kinesthetic intelligence improvement.



Energetic
play

+3 - 5

556

Scooter, small ▶

The scooter challenges the children's sense of coordination and balance which improves bodily/kinesthetic intelligence. After driving on a tricycle it is a new world to scoot around on 2 wheels! Lots of fun for everyone.



Energetic play



+4 - 7

555

◀ **Circleline Twin Taxi**

A taxi for three children that opens up for many social games and role playing activities helping their intrapersonal intelligence to be developed. The child may take his best friends for a ride, acting as a driver, while his friends are chatting in the back. Cool and sturdy design! It also helps bodily/kinesthetic intelligence to be improved.





+3 - 6

558

▼ **Bicycle**

When riding this bicycle the children have reached the ultimate freedom to explore the world. They can easily get around and use their motor skills like an adult. Ideal for bodily/kinesthetic intelligence improvement



+3 - 5

559

Bike Runner ▲

The BikeRunner is the perfect choice when teaching the children to develop their sense of balance. The bike is pushed forward using the feet. Helps children to develop their bodily/kinesthetic intelligence



Energetic
play

Sand and water tray

This strong and versatile plastic play tray features a water release plug in the bottom for easy discharge. Includes a strong tubular frame fitted with two lockable casters for easy movement. The tray measures 110 x 60.5 x 21.5 cm deep, and weight 8 kgs (toys not included). The colored tubular steel frame is designed to hold the Sand and Water Play tray. Two heights of frame are available, 40cm and 58cm. Sturdy plastic lid cover included. Ideal for developing bodily/kinesthetic and interpersonal intelligence.



Clear / H 40 cm - 66010
Clear / H 58 cm - 66011



Colored / H 40 cm - 66020



Energetic play

66050

Circular sand & water Tray ▶

Circular sand and water tray is designed with multiple interior levels and slopes to allow children to explore many different activities. Ideal for developing bodily/kinesthetic and interpersonal intelligence. Constructed of strong durable plastic, with a heavy duty steel tubular frame. Comes with a plastic molded lid. Dimensions 75cm diameter, Size : height 58 cm.



Desktop Water Tray

These stackable sand and water trays are ideal for early childhood centers and classrooms with limited space. Helps develop bodily/kinesthetic and interpersonal intelligence. Size W50 x L70 x H15cm



Clear - 66090
Colored - 66094



66099

Desk Top Water Tray Stand ▶

Folding sturdy steel frame with a nylon shelf and two casters to allow easy movement around the classroom. Fits our Desk Top Sand and Water Trays. Helps develop bodily/kinesthetic and interpersonal intelligence. Frame measures 58cm high and 48 x 70cm long. (Tray is not included)



Energetic
play



KG Furniture

EDU FUN welcomes you to its KG Furniture section, which provides a complete solution for pre-school and kindergarten education. In this section you can find a full range of furniture which suits the requirements of children in their early years. We believe in the importance of providing practical, suitable and comfortable designs to fulfill the demands of this critical stage. Our modular designs make it easy to set up unique configurations to suit children needs. The colourful, attractive and durable designs encourage good posture and ensure years of safe and enjoyable use. All this we offer at affordable and compatible prices.





















Flexo Collection



Tables

These flexible movable Creative tables combines contemporary looks, functionality as well as flexibility encourage social behavior, creativity and cooperation among students. It comes in a variety of unique shapes; sizes, each shape and size have its merits and benefits, depending on the learning situation. Tables can be combined with each other or with other tables combining multitude of layouts creating an attractive look. Made of Medium-density fiberboard (MDF) covered by high pressure laminate (HPL), with ABS edge banding .Legs available fixed or adjustable to offer different heights, which can be an advantage for mixed age groups.

Colours



For more details, please check page 40-41

Chairs

Modern and Ergonomically designed plastic shell to increase seating comfort. The robust seat surface resists scratches and is easy to clean. Glides guarantee stability and minimum abrasion on all types of floors. The design of legs makes them stackable for easy storage.

Colours



For more details, please check page 36



Storage Units

Our perfectly flexible storage units offer a lot of options and arrangements. All units are 40 cm deep to link them together and create a multitude of layouts with different heights. Designed empty to complete with storage wooden trays, or plastic trays (with anti-fall safety runners) . The shelves are extremely resistant and designed to support the weight of heavy books and objects. Made of Medium-density fiberboard (MDF) and melamine coated on both sides , doors coated by high pressure laminate (HPL) , with ABS edge banding . Available in single, double, triple and quadruple unit can be assembled upon request.



For more details, please check page 52 - 59

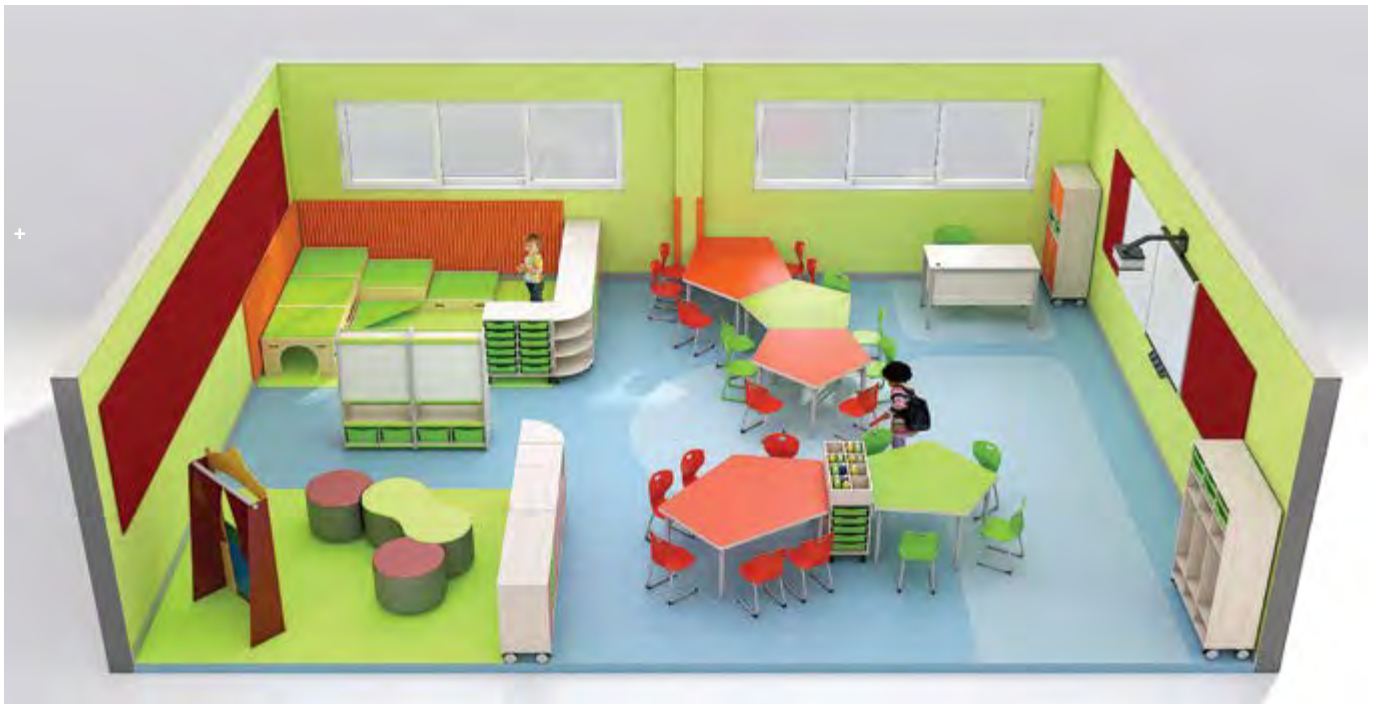
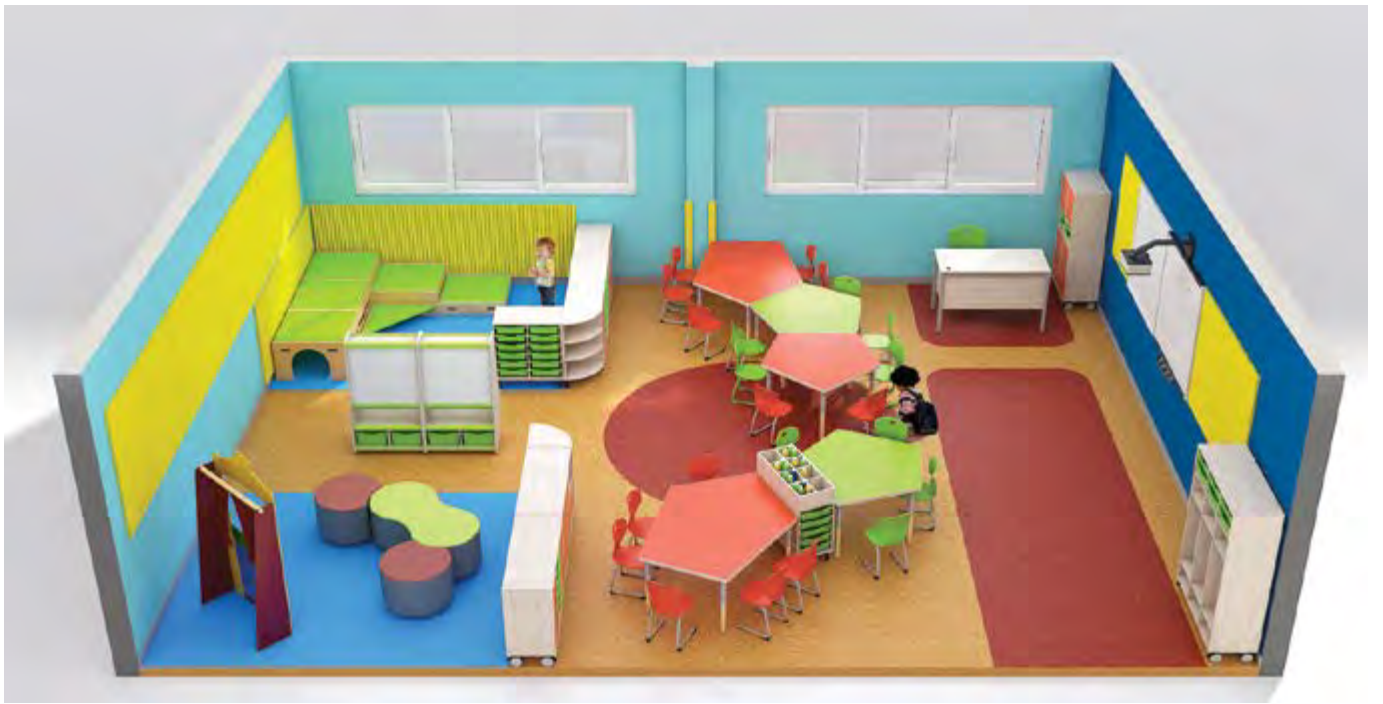

KG
Furniture

Elegance Collection



Tables

Our lines of Elegance Tables come packed- flat for your convenience. The tables are easily assembled with the simple instructions provided. When correctly assembled, our tables are solid ,stable and durable. Tables come in 4 convenient heights and table- tops are available in 11 functional shape . All our tables are modular, so they can be arranged in many different configurations .Tables have coloured, laminated M.D.F table- tops with clear lacquered beech wood frames.

Colours



For more details, please check page 41

Chairs

These beautifully crafted stackable chairs would look great in any classroom. Each chair is made of solid, top-quality lacquered beech wood and is built to last. Four convenient seat heights are available to correspond with Elegance tables. Available with arms.

Colours



For more details, please check page 28



Storage Units

The simple and functional designs of our collection of modular units offer perfect solutions for your storage problems. Available in 7 different designs and sizes to suit your needs.

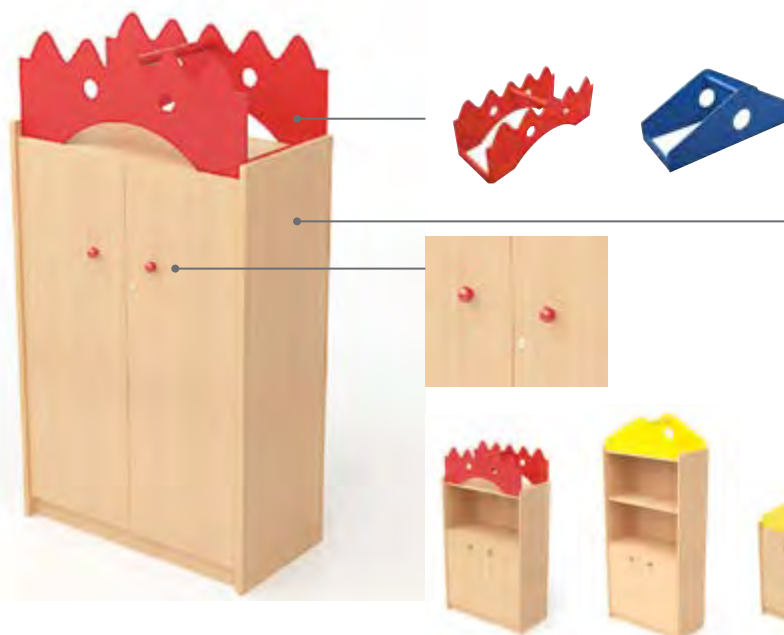

For more details, please check page 64



■ Comby Collection

Tables

Classic Tables can be arranged in various groupings to suit your needs. Four table heights are available to correspond with Classic K.G. and Nursery chairs. Tables have laminated M.D.F tops and clear lacquered frames in 2 sizes, trapezoidal, circular and semicircular. All edges are rounded to prevent any risk of injury.

Colours



For more details, please check page 46

Chairs

Top quality, colourful chairs that will last for generations. These Classic chairs are made with a solid beech wooden frame, strong enough for even an adult to stand on. Seats are coloured laminated MDF board.

Colours



For more details, please check page 26



Storage Units

This range of storage units available in 2 versions: lower units and upper units. Some models are available with lower wooden boxes on wheels. These storage units are made of high quality non-scratch, washable, melamine coated, 18 mm thick M.D.F. They come in beech wood patterned melamine with rounded-off rimmed thick plastic edges. Doors and drawers are made of natural beech wood and painted with non-toxic paints.

Colours





Curvy Collection

Tables

Well - designed Curvy tables can handle any activity with wide range of shapes makes Curvy tables can suite various numbers of children. The legs height can be adjusted with just an easy turn in the screw & table-top is covered with formica.

Colours



For more details, please check page 48

Chair

A very unique ultra durable metal frame design, with an attractive colourful textured polypropylene in one piece seat and back. Colourful rounded glides for hard and soft floors. Suitable for Curvy & Soft table sets. One height.

Colours



For more details, please check page 37



Storage Units

As well as looking attractive, this series of tray storage units are flexible and versatile. This collection was designed to fulfill the storage needs of any learning environment like KG and art classrooms. The wonderful colors of the trays & shelves give you the ability to make endless collections of colors to match your room design.





■ Multi Collection

Tables

Activity table, one of the most versatile furnishings that are important for enhancing the learning environment for students. It comes in a variety of unique shapes, sizes, and colours making them ideal solution for student collaboration and interaction in today's multi-zone learning environments. It is a height adjustable tables features a high-pressure laminate surface for long lasting use. . Made of Medium-density fiberboard (MDF) covered by high pressure laminate (HPL), with ABS edge banding .Legs available fixed or adjustable to offer different heights, which can be an advantage for mixed age groups.

Colours



For more details, please check page 42

Chairs

Durable, comfortable and light chairs. Constructed with premium formed metal pipes. Seat and back are made from multiple-layer plywood . The large front seating edge supports good posture. The doweled plastic glides are gentle to the floor even after years of use. Chair is stackable up to 6 chairs. Available in 6 metal frame colours.

Colours



For more details, please check page 35

Storage Units

The colorful acrylic back panels allow the light to shine through, giving charming effects. The unique curved design allows dynamic arrangements such as semicircular, circular and S shape. Modular units help creating a variety of combination possibilities. Made of an attractive combination of wood & acrylic. Great as a room divider. Available with coaster to give maximum flexibility in the educational space.

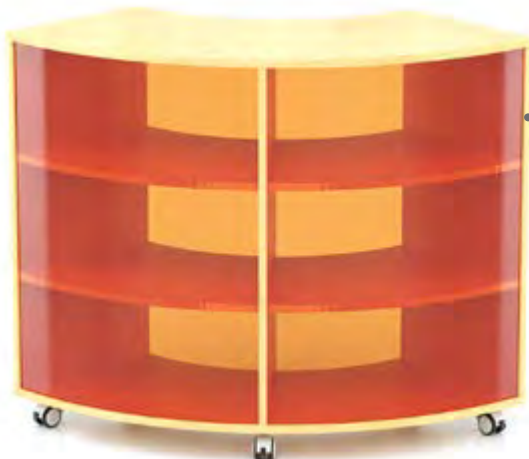

For more details, please check page 60



KG Furniture Chairs

- Star
- Woody
- Curvy woody **New**
- Classic Plus
- Classic
- NEW classic **New**
- Deluxe
- Elegance
- Elegance stool **New**
- Flip around chair **New**
- High Chair
- Toddler Chair
- Captin Chair
- Toddler stool
- Stool **New**
- Benches
- Puff
- Premium
- Simple
- NEW simple **New**
- Curvy
- Candy
- Flexo L **New**
- Flexo N **New**
- EN10





Star Chair

Ultra modern design, manufactured with a high quality beech wood frame. Ergonomically shaped back & seat give maximum comfort & ease of use. Seats are available in 2 sizes.



Woody Chair

These chairs are perfect companions to our wooden student desks (Elegance-Classic). Chairs have ergonomic designs and provide proper back support. Children can easily move these light chairs around. Seats are available in 2 sizes.



Curvy Woody Chair

This curved woody chair combines the durability of the woody chair with curved edges for softer look. The ergonomic designs provide proper back support. It is suitable for children to move these chairs around. Seats are available in 2 sizes.

NEW



C2 H.31 cm - 29.5x37.5 cm - 48120	C2 H.31 cm - 30x32 cm - 43215	C2 H.31 cm - 32x32 cm - 43107
C3 H.35 cm - 29.5x37.5 cm - 48121	C3 H.35 cm - 30x32 cm - 43216	C3 H.35 cm - 32x32 cm - 43109



Seat & Back Colours



Structure color



Leg-tips have plastic caps to prevent noise & marring of floor surface when moved.

Safe rounded corners

Classic Plus Chair

Natural beech wood with HQ finishes, this very light and sturdy design offers durability and ease of movement. The Colourful birch plywood seats are available in 4 colours.



*Whole seat colored

- C0** H. 22 cm - 28.5 x 28.5 cm - **43120**
- C1** H. 26 cm - 28.5 x 28.5 cm - **43121**
- C2** H. 31 cm - 30 x 30 cm - **43122**
- C3** H. 35 cm - 30 x 30 cm - **43123**

- *43125**
- *43126**
- *43127**
- *43128**

Classic Chair

Top quality, colourful chairs that will last for generations. These Classic chairs are made with a solid beech wooden frame, strong enough for even an adult to stand on. Seats are coloured laminated MDF board.



Classic S Chair

This chair combines all the advantages of the classic chair in addition of stacking. Top quality, colourful chair that will last for generations. The frame is made of solid beech wooden and seat is made from coloured laminated MDF boards. It is one of the best durable strong chairs that can bear for an adult to stand on.



ST

- C0** H. 22 cm - 28.5 x 28.5 cm - **43115**
- C1** H. 26 cm - 28.5 x 28.5 cm - **43116**
- C2** H. 31 cm - 30 x 30 cm - **43117**
- C3** H. 35 cm - 30 x 30 cm - **43118**

- C0** H. 22 cm - 33 x 30 cm - **43140**
- C1** H. 26 cm - 33 x 30 cm - **43141**
- C2** H. 31 cm - 35 x 30 cm - **43142**
- C3** H. 35 cm - 35 x 30 cm - **43143**



Leg-tips have plastic caps to prevent noise & marring of floor surface when moved.



Natural beech wood structure

Seat & Back Colours



Structure color



Deluxe Chair

More ergonomic colourful chairs that will last for generations. Each chair is made of solid, top-quality lacquered beech wood & plywood. Available in 5 different colours and 3 different heights. Available with arms.

Elegance Chair

These beautifully crafted stackable chairs would look great in any classroom. Each chair is made of solid, top-quality lacquered beech wood and is built to last. Four convenient seat heights are available to correspond with Elegance tables. Available with arms.

Elegance Stool

This stool is made of solid Beech wood frame and laminated plywood seat. No sharp corners so children won't catch toes or clothes. The neutral tone makes it compatible with many tables. Gentle to the floor Doweled plastic glides even after years of use. Its construction assures strength, stability and support.



ST



ST



C1 H. 26 cm - 23.5x25 cm - 43275 *43266	C0 H. 22 cm - 27.5x23 cm - 43201 *43206	C0 H. 22 cm - 32x33 cm - 43330
C2 H. 31 cm - 26x27.5 cm - 43280 *43267	C1 H. 26 cm - 27.5x23 cm - 43202 *43207	C1 H. 26 cm - 32x33 cm - 43331
C3 H. 35 cm - 28.5x31 cm - 43285 *43268	C2 H. 31 cm - 30x25.5 cm - 43203 *43208	C2 H. 31 cm - 32x33 cm - 43332
	C3 H. 35 cm - 30x25.5 cm - 43204 *43209	C3 H. 35 cm - 32x33 cm - 43333



Seat & Back Colours



Structure color



Ergonomically curved seat and back rest



Chairs are stackable or put on table-top for easy classroom cleaning



Premium chair

The ergonomic chair design makes it comfortable and encourages children to sit properly. It is sturdy, durable and practical. It is constructed with premium formed metal pipes, seat and back from plywood. Round glides for hard and soft floors.



ST

Simple Chair

Sturdy, durable & light chairs. Constructed with superior formed metal pipes, seat and back from environmental-friendly plywood for comfort seating. Available in 6 metal frame colours. Two heights suitable for Curvy & Soft table sets.



ST

Simple S Chair

Durable, comfortable and light chairs. Constructed with premium formed metal pipes. Seat and back are made from multiple-layer plywood. The large front seating edge supports good posture. The doweled plastic glides are gentle to the floor even after years of use. Chair is stackable up to 6 chairs. Available in 6 metal frame colours.



ST

C2 H.31 cm - 34x44 cm - 43518	C2 H.31 cm - 34x44 cm - 43505	C2 H.31 cm - 35x32 cm - 48433
C3 H.35 cm - 34x44 cm - 43519	C3 H.35 cm - 34x44 cm - 43506	C3 H.35 cm - 35x32 cm - 48434



C0... Nursery1
C1... Nursery2
C2... K.G 1
C3... K.G 2

Seat & back rest Colours



Metal Frame Colours



Flexo L Chair

Modern and Ergonomically designed plastic shell to increase seating comfort. The robust seat surface resists scratches and is easy to clean. Glides guarantee stability and minimum abrasion on all types of floors. The design of legs makes them stackable for easy storage. . Available in 6 metal frame colours



ST

Flexo N Chair

Modern and Ergonomically designed plastic shell to increase seating comfort. The robust seat surface resists scratches and is easy to clean. Glides guarantee stability and minimum abrasion on all types of floors. The design of legs makes them stackable for easy storage. . Available in 6 metal frame colours



ST

C2 H.31 cm - 30x32 cm - 43527	C2 H.31 cm - 35x32 cm - 43525	
C3 H.35 cm - 30x32 cm - 43528	C3 H.35 cm - 35x32 cm - 43526	



Soft Plastic Seat Colours



Metal Frame Colours



Curvy Chair

A very unique ultra durable metal frame design, with an attractive colourful textured polypropylene a one piece seat and back. Colourful rounded glides for hard and soft floors. Suitable for Curvy & Soft table sets. One height.



ST

Candy Chair

Colourful strong and attractive plastic moulded chairs designed for heavy use. The chairs' ergonomic design makes them particularly comfortable and encourages children to sit properly. The colourful design makes them attractive. Available in 4 colours. One height suitable for Curvy & Soft table sets.



ST

C3 H.35 cm - 28.5x31 cm - 43111	C2 H.31 cm - 30x30 cm - 43510	

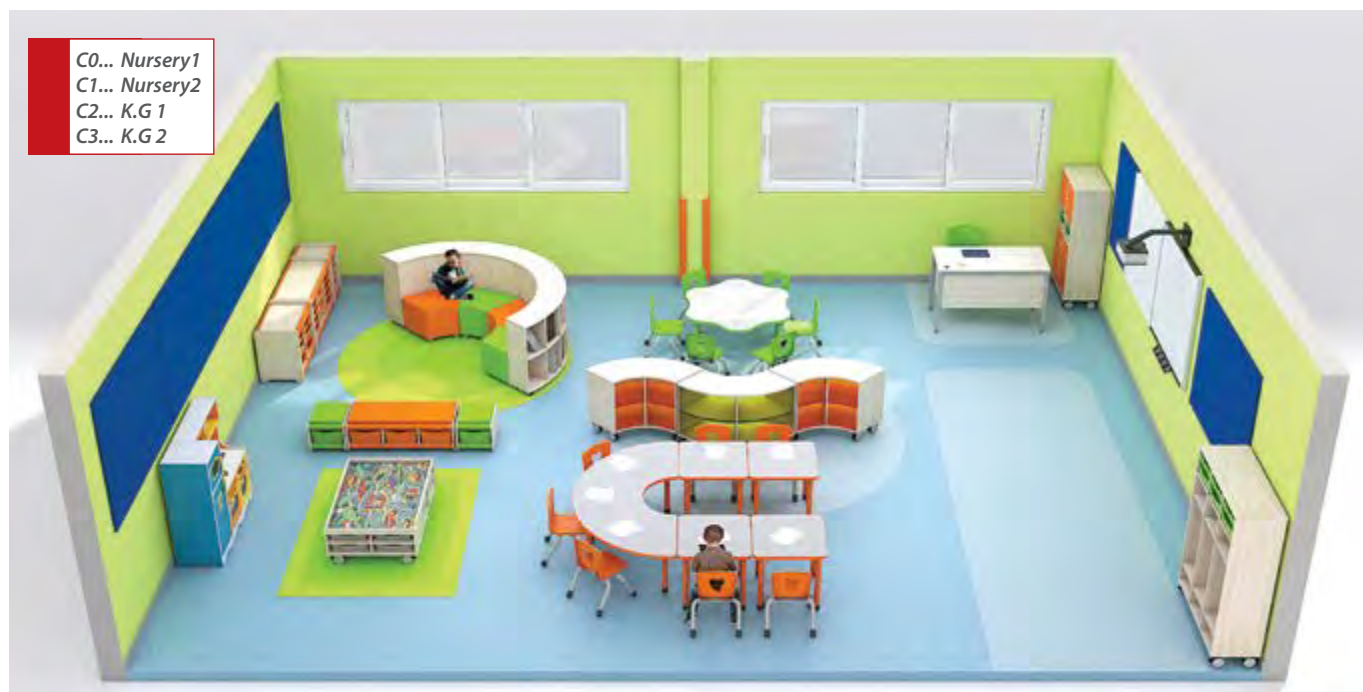

- C0... Nursery1
- C1... Nursery2
- C2... K.G 1
- C3... K.G 2

Soft Plastic Seat Colours



Metal Frame Colours



EN10 Series Chair

- Frame colour silver gray
- stacks 6 high

EN11 Series Chair

- Angled rear legs to discourage user tilting
- Frame colour chrome
- stacks 6 high

EN12 Series Chair

- Linking frames for fire regulations
- Angled rear legs to discourage user tilting
- Frame colour silver gray
- stack 6 high



ST

ST

ST

C0 H. 26 cm - 35 x 46.3 cm - 48600		
C1 H. 31 cm - 35 x 46.3 cm - 48601		
C2 H. 31 cm - 40 x 51.3 cm - 48602		
C3 H. 35 cm - 40 x 51.3 cm - 48603		
C4 H. 43 cm - 46 x 56.3 cm - 48604		
C5 H. 46 cm - 46 x 56.3 cm - 48605	C5 H. 46 cm - 46 x 56.3 cm - 48606	C5 H. 46 cm - 46 x 56.3 cm - 48607

Seat & back rest Colours



*Only available in size C4 and C5

Metal Frame Colours



Seat & back rest Colours



Metal Frame Colours



Seat & back rest Colours



Metal Frame Colours



- C0... Nursery1
- C1... Nursery2
- C2... K.G 1
- C3... K.G 2
- C4... Primary
- C5... Prep

KG
Furniture



Chair 30 x 26 cm

NEW

Flip around Chair

This infant to toddler sized chair is perfect for small children. The chair is light that children can turn it around by themselves. The seat height is different when you turn it over, or can be turned to a table. Also it has Oval holes on its sides to facilitate handling. Made from laminated plywood.

C0 H.22 cm - 30x26 cm - 43340

C1 H.26 cm - 30x26 cm - 43341



Chair 30 x 26 cm



Table 30 x 30 cm



High Chair

This high chair is perfect to your child to have fun. It can be used for your baby from about 6 months up to 2 years. Enables him to play, feed and learn in a safe and cozy design, equipped with seat belts to secure the infants and to prevent accidents. Excellent for child-care centres, nurseries or home. Manufactured from HQ beech wood non-toxic colours and with a lacquered finish.

48x45x79 cm - 43500



Toddler Chair

This wooden toddler chair is a good gift for your child from (1-4 years). Excellent for child-care centres, nurseries or children's rooms at home. It encourages your young ones to behave and sit in a proper way. Designed with safe edges & manufactured from HQ beech wood and with a lacquered finish.

37x38x41.5 cm - 43501



Chair

Toddler stool

Colorful 4 legs stool chairs assorted with round wooden table top designed for toddlers. Stool legs and table are designed for maximum stability. Rounded corners ensure safety for toddlers. Ideal for home or nursery use. Made of solid, top-quality lacquered beech wood & plywood. Flat back

Chair

C0	H.22 cm - 30 x 30 cm - 43261
C1	H.26 cm - 30 x 30 cm - 43262

Seat Colours



Structure color



Table

C0	H.40 cm - 60 x 60 cm - 43263
C1	H.46 cm - 60 x 60 cm - 43264



Table



NEW

Stool

A very high quality piece of furniture. This stool is made of solid Beech wood frame and laminated plywood seat. Stool legs have double dowel connection lines to guarantee maximum Stability. Curved-leg design has no corners on which little ones can get themselves caught. Easy to assemble for storage. The neutral tone makes them perfect companions with many tables. The doweled plastic glides are gentle to the floor even after years of use.

C0	H.22 cm - ø 34 cm - 43320
C1	H.26 cm - ø 34 cm - 43321
C2	H.31 cm - ø 34 cm - 43322
C3	H.35 cm - ø 34 cm - 43323



Captin Chair

A classic style seating made from high quality solid beech wood with a recessed wooden seat base & a wrap-around seat back, providing back and side support for children. Suitable for growing toddlers who are starting to become more independent but still providing much needed security. Durable varnish in natural polished finish, robustly constructed for heavy usage & long lasting.

39.5x39.5x51.5 cm - **43515**



KG
Furniture

Benches

This ergonomic wooden bench is a great addition to your classroom or day care centers. It is made of solid, top-quality lacquered beech wood & plywood. Great for mixed-age groups. Benches can be nested together to save space.



- C1 H. 26 cm - 96.5 x 25 cm - [43286](#)
- C2 H. 31 cm - 96.5 x 27.5 cm - [43287](#)
- C3 H. 35 cm - 96.5 x 31 cm - [43288](#)

NEW



- C0 H. 22 cm - Chair 67 x 26 cm / Table 67 x 30 cm - [43345](#)
- C1 H. 26 cm - Chair 67 x 26 cm / Table 67 x 30 cm - [43346](#)



Kinder Chair

- C0 H. 22 cm - 36 x 40 cm - [43220](#)
- C1 H. 26 cm - 36 x 40 cm - [43221](#)
- C2 H. 31 cm - 36 x 40 cm - [43222](#)
- C3 H. 35 cm - 36 x 40 cm - [43223](#)



Kinder Bench

- C0 H. 22 cm - 70 x 40 cm - [43225](#)
- C1 H. 26 cm - 70 x 40 cm - [43226](#)
- C2 H. 31 cm - 70 x 40 cm - [43227](#)
- C3 H. 35 cm - 70 x 40 cm - [43228](#)



Kinder Bench

- C0 H. 22 cm - 100 x 40 cm - [43230](#)
- C1 H. 26 cm - 100 x 40 cm - [43231](#)
- C2 H. 31 cm - 100 x 40 cm - [43232](#)
- C3 H. 35 cm - 100 x 40 cm - [43233](#)



Kinder Chair with back seat

- C0 H. 22 cm - 36 x 40 cm - [43235](#)
- C1 H. 26 cm - 36 x 40 cm - [43236](#)
- C2 H. 31 cm - 36 x 40 cm - [43237](#)
- C3 H. 35 cm - 36 x 40 cm - [43238](#)



Kinder Bench with back seat

- C0 H. 22 cm - 70 x 40 cm - [43240](#)
- C1 H. 26 cm - 70 x 40 cm - [43241](#)
- C2 H. 31 cm - 70 x 40 cm - [43242](#)
- C3 H. 35 cm - 70 x 40 cm - [43243](#)



Kinder Bench with back seat

- C0 H. 22 cm - 100 x 40 cm - [43245](#)
- C1 H. 26 cm - 100 x 40 cm - [43246](#)
- C2 H. 31 cm - 100 x 40 cm - [43247](#)
- C3 H. 35 cm - 100 x 40 cm - [43248](#)



Benches

These well designed benches provide colorful seating for children in classrooms, library or playing area. There are 3 types of these benches:

- Trapezoidal bench which allows variety of combinations.
- Rectangle bench with drawer which can be used for reading or playing time.
- Multi height bench with drawer which attract children to sit together and also can be used for play and reading times.



C2 H. 30 cm - 100x47 cm - 43310



100x45x35 cm - 43315



100x70x35 cm - 45175

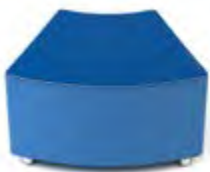

C2 H. 31 cm - ø 45 cm - 43534

C3 H. 35 cm - ø 45 cm - 43544

Pouf

Colourful and comfortable, our line of pre-school and school seating for reception areas, corridors and classrooms. It can compose different formations to give a shiny colourful breath to your interior.

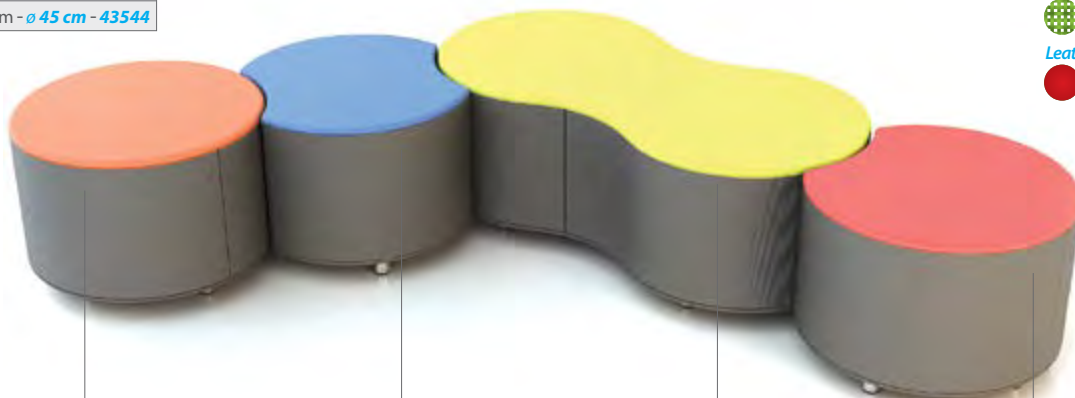
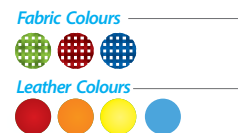

C2 H. 31 cm - ø 45 cm - 43530

C3 H. 35 cm - ø 45 cm - 43540

C2 H. 31 cm - ø 45 cm - 43531

C3 H. 35 cm - ø 45 cm - 43541

C2 H. 31 cm - 90 cm - 43532

C3 H. 35 cm - 90 cm - 43542

C2 H. 31 cm - ø 45 cm - 43533

C3 H. 35 cm - ø 45 cm - 43543

KG Furniture Tables

Flexo **New**
Multi **New**
Elegance
Classic
Ultra
Curvy
Mobile table & seat system





KG
Furniture

Flexo Tables NEW

NEW

These flexible movable Creative tables combines contemporary looks, functionality as well as flexibility encourage social behavior, creativity and cooperation among students. It comes in a variety of unique shapes; sizes, each shape and size have its merits and benefits, depending on the learning situation. Tables can be combined with each other or with other tables combining multitude of layouts creating an attractive look. Made of Medium-density fiberboard (MDF) covered by high pressure laminate (HPL), with ABS edge banding .Legs available fixed or adjustable to offer different heights, which can be an advantage for mixed age groups.

- C0... Nursery1
- C1... Nursery2
- C2... K.G 1
- C3... K.G 2



KG Furniture



Flexo table		Flexo table		Flexo table	
C2 H. 53 cm - 120x120 cm - 44700	multi H. - 44701	C2 H. 53 cm - 180x120 cm - 44704	multi H. - 44705	C2 H. 53 cm - 130x120 cm - 44708	multi H. - 44709
C3 H. 59 cm - 120x120 cm - 44702		C3 H. 59 cm - 180x120 cm - 44706		C3 H. 59 cm - 130x120 cm - 44710	

Flexo table		Flexo table		Flexo table	
C2 H. 53 cm - 80x80 cm - 44712	multi H. - 44713	C2 H. 53 cm - 120x120 cm - 44716	multi H. - 44717	C2 H. 53 cm - 105x105 cm - 44720	multi H. - 44721
C3 H. 59 cm - 80x80 cm - 44714		C3 H. 59 cm - 120x120 cm - 44718		C3 H. 59 cm - 105x105 cm - 44722	

Flexo table	
C2 H. 53 cm - 90x80 cm - 44724	multi H. - 44725
C3 H. 59 cm - 90x80 cm - 44726	



Table - Top Colours



KG
Furniture

NEW

Multi Tables

Activity table, one of the most versatile furnishings that are important for enhancing the learning environment for students. It comes in a variety of unique shapes, sizes, and colours making them ideal solution for student collaboration and interaction in today's multi-zone learning environments. It is a height adjustable tables features a high-pressure laminate surface for long lasting use. . Made of Medium-density fiberboard (MDF) covered by high pressure laminate (HPL), with ABS edge banding .Legs available fixed or adjustable to offer different heights, which can be an advantage for mixed age groups.

- C0... Nursery1
- C1... Nursery2
- C2... K.G 1
- C3... K.G 2



KG Furniture



Multi table		Multi table		Multi table	
C2 H. 53 cm - 100x95 cm - 44728	multi H. - 44729	C2 H. 53 cm - 120x60 cm - 44732	multi H. - 44733	C2 H. 53 cm - 120x120 cm - 44736	multi H. - 44737
C3 H. 59 cm - 100x95 cm - 44730		C3 H. 59 cm - 120x60 cm - 44734		C3 H. 59 cm - 120x120 cm - 44738	
Multi table		Multi table		Multi table	
C2 H. 53 cm - 180x78 cm - 44740	multi H. - 44741	C2 H. 53 cm - 120x80 cm - 44744	multi H. - 44745	C2 H. 53 cm - 120x80 cm - 44748	multi H. - 44749
C3 H. 59 cm - 180x78 cm - 44742		C3 H. 59 cm - 120x80 cm - 44746		C3 H. 59 cm - 120x80 cm - 44750	
Multi table		Multi table		Multi table	
C2 H. 53cm - 180x120 cm - 44752	multi H. - 44753	C2 H. 53 cm - ø 100 cm - 44756	multi H. - 44757	C2 H. 53cm - ø 90 cm - 44760	multi H. - 44761
C3 H. 59 cm - 180x120 cm - 44754		C3 H. 59 cm - ø 100 cm - 44758		C3 H. 59 cm - ø 90 cm - 44762	

Table - Top Colours



Available with casters

With Casters



Recommended chairs

Simple S

KG Furniture

Elegance Tables

Our lines of Elegance Tables come packed-flat for your convenience. The tables are easily assembled with the simple instructions provided. When correctly assembled, our tables are solid ,stable and durable. Tables come in 4 convenient heights and table- tops are available in 11 functional shapes . All our tables are modular, so they can be arranged in many different configurations .Tables have coloured, laminated M.D.F table- tops with clear lacquered beech wood frames.

- C0... Nursery1
- C1... Nursery2
- C2... K.G 1
- C3... K.G 2

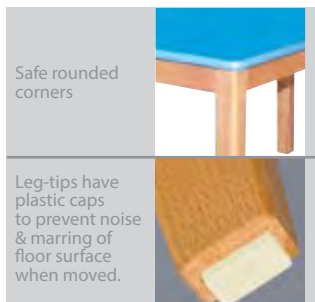

Safe rounded corners

Leg-tips have plastic caps to prevent noise & marring of floor surface when moved.



Deluxe

Elegance



<p>C0 H. 40 cm - 60x80 cm - 44321</p>	<p>C0 H. 40 cm - 120x60 cm - 44331</p>	<p>C0 H. 40 cm - 120x60 cm - 44511</p>
<p>C1 H. 46 cm - 60x80 cm - 44322</p>	<p>C1 H. 46 cm - 120x60 cm - 44332</p>	<p>C1 H. 46 cm - 120x60 cm - 44512</p>
<p>C2 H. 53 cm - 60x80 cm - 44323</p>	<p>C2 H. 53 cm - 120x60 cm - 44333</p>	<p>C2 H. 53 cm - 120x60 cm - 44513</p>
<p>C3 H. 59 cm - 60x80 cm - 44324</p>	<p>C3 H. 59 cm - 120x60 cm - 44334</p>	<p>C3 H. 59 cm - 120x60 cm - 44514</p>



<p>C0 H. 40 cm - ø 120 cm - 44410</p>	<p>C0 H. 40 cm - ø 90 cm - 44415</p>	<p>C0 H. 40 cm - 120x52 cm - 44201</p>
<p>C1 H. 46 cm - ø 120 cm - 44411</p>	<p>C1 H. 46 cm - ø 90 cm - 44416</p>	<p>C1 H. 46 cm - 120x52 cm - 44202</p>
<p>C2 H. 53 cm - ø 120 cm - 44412</p>	<p>C2 H. 53 cm - ø 90 cm - 44417</p>	<p>C2 H. 53 cm - 120x52 cm - 44203</p>
<p>C3 H. 59 cm - ø 120 cm - 44413</p>	<p>C3 H. 59 cm - ø 90 cm - 44418</p>	<p>C3 H. 59 cm - 120x52 cm - 44204</p>



<p>C0 H. 40 cm - ø 120 cm - 44685</p>	<p>C0 H. 40 cm - 60x120 cm - 44675</p>	<p>C0 H. 40 cm - 180x120 cm - 44670</p>
<p>C1 H. 46 cm - ø 120 cm - 44686</p>	<p>C1 H. 46 cm - 60x120 cm - 44676</p>	<p>C1 H. 46 cm - 180x120 cm - 44671</p>
<p>C2 H. 53 cm - ø 120 cm - 44687</p>	<p>C2 H. 53 cm - 60x120 cm - 44677</p>	<p>C2 H. 53 cm - 180x120 cm - 44672</p>
<p>C3 H. 59 cm - ø 120 cm - 44688</p>	<p>C3 H. 59 cm - 60x120 cm - 44678</p>	<p>C3 H. 59 cm - 180x120 cm - 44673</p>



<p>C0 H. 40 cm - 120x80 cm - 44680</p>	<p>C0 H. 40 cm - 60x60 cm - 44690</p>
<p>C1 H. 46 cm - 120x80 cm - 44681</p>	<p>C1 H. 46 cm - 60x60 cm - 44691</p>
<p>C2 H. 53 cm - 120x80 cm - 44682</p>	<p>C2 H. 53 cm - 60x60 cm - 44692</p>
<p>C3 H. 59 cm - 120x80 cm - 44683</p>	<p>C3 H. 59 cm - 60x60 cm - 44693</p>

KG
Furniture

Classic Tables

Classic Tables can be arranged in various groupings to suit your needs. Four table heights are available to correspond with Classic K.G. and Nursery chairs. Tables have laminated M.D.F tops and clear lacquered frames in 2 sizes and 4 functional shapes. All edges are rounded to prevent any risk of injury.



C0... Nursery1
C1... Nursery2
C2... K.G 1
C3... K.G 2

Classic - Rectangular Table

Classic - Rectangular Table

Classic - Trapezoidal Table



- C0 H. 40 cm - 60x90 cm - 44313
- C1 H. 46 cm - 60x90 cm - 44314
- C2 H. 53 cm - 60x90 cm - 44311
- C3 H. 59 cm - 60x90 cm - 44312

- C0 H. 40 cm - 120x60 cm - 44301
- C1 H. 46 cm - 120x60 cm - 44302
- C2 H. 53 cm - 120x60 cm - 44303
- C3 H. 59 cm - 120x60 cm - 44304

- C0 H. 40 cm - 60x90 cm - 44103
- C1 H. 46 cm - 60x90 cm - 44104
- C2 H. 53 cm - 60x90 cm - 44101
- C3 H. 59 cm - 60x90 cm - 44102

Classic - Semi Circular Table



- C0 H. 40 cm - 120x60 cm - 44501
- C1 H. 46 cm - 120x60 cm - 44502
- C2 H. 53 cm - 120x60 cm - 44503
- C3 H. 59 cm - 120x60 cm - 44504

Table - Top Colours



KG Furniture

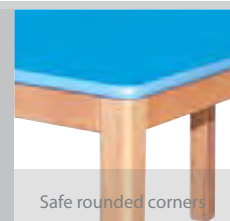

Safe rounded corners



Leg-tips have plastic caps to prevent noise & marring of floor surface when moved.



Classic Plus

Classic



Ultra Tables

This range offers durable tables. Metal frame and colorful laminated table-top with colored edge. The plastic glides for soft and hard floors. Costers are available in one side for easy moving.

- C0... Nursery1
- C1... Nursery2
- C2... K.G 1
- C3... K.G 2

- F... Fixed
- M... Movable





C2 H 53 cm - 60x120 cm - F 44621 - M 44640
 C3 H 59 cm - 60x120 cm - F 44626 - M 44645

C2 H 53 cm - 60x120 cm - F 44624 - M 44642
 C3 H 59 cm - 60x120 cm - F 44629 - M 44647

C2 H 53 cm - 120x120 cm - F 44625 - M 44643
 C3 H 59 cm - 120x120 cm - F 44630 - M 44648



C2 H 53 cm - 50x120 cm - F 44623 - M 44641
 C3 H 59 cm - 50x120 cm - F 44628 - M 44646

C2 H 53 cm - 60x80 cm - F 44622 - M 44644
 C3 H 59 cm - 60x80 cm - F 44627 - M 44649

C2 H 53 cm - 60x120 cm - F 44631 - M 44635
 C3 H 59 cm - 60x120 cm - F 44632 - M 44636



C2 H 53 cm - 80x80 cm - 44660
 C3 H 59 cm - 80x80 cm - 44661

C2 H 53 cm - 60x120 cm - 44663
 C3 H 59 cm - 60x120 cm - 44664

C2 H 53 cm - 50x120 cm - 44665
 C3 H 59 cm - 50x120 cm - 44666



C2 H 53 cm - 60x120 cm - 44667
 C3 H 59 cm - 60x120 cm - 44668

Table - Top Colours

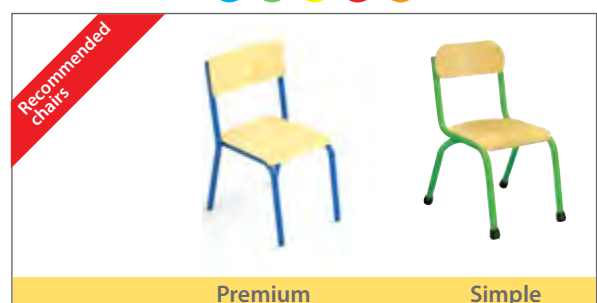

























KG Furniture

Curvy Tables

Well - designed Curvy tables can handle any activity & wide range of shapes makes Curvy tables can suite various numbers of children. The legs height can be adjusted with just an easy turn in the screw & table-top is covered with formica.

- C0... Nursery1
- C1... Nursery2
- C2... K.G 1
- C3... K.G 2



<p><i>Curvy</i> - Square Table</p>  <p> 2</p> <p>60x60 cm - 44440</p>	<p><i>Curvy</i> - Rectangular Table</p>  <p> 6</p> <p>120x60 cm - 44443</p>	<p><i>Curvy</i> - Long Table</p>  <p> 8</p> <p>160x60 cm - 44445</p>
<p><i>Soft</i> - Square Table</p>  <p> 2</p> <p>60x60 cm - 44441</p>	<p><i>Soft</i> - Rectangular Table</p>  <p> 6</p> <p>120x60 cm - 44444</p>	<p><i>Soft</i> - Long Table</p>  <p> 8</p> <p>160x60 cm - 44446</p>
<p><i>Curvy</i> - Semi-circular Table</p>  <p> 6</p> <p>120x180 cm - 44449</p>	<p><i>Curvy</i> - Kidney Table</p>  <p> 6</p> <p>120x180 cm - 44610</p>	<p><i>Curvy</i> - Circle Table</p>  <p> 6</p> <p>ø 120 cm - 44447</p>
<p><i>Curvy</i> - Quarto circle Table</p>  <p> 4</p> <p>80x170 cm - 44448</p>	<p><i>Curvy</i> - Rosy Table</p>  <p> 6</p> <p>ø 120 cm - 44430</p>	<p><i>Curvy</i> - Semi Quarto circle Table</p>  <p> 3</p> <p>60x100 cm - 44461</p>

KG
Furniture

Mobile Table & Seat Systems, Foldable Space Miracle

More and more schools, kindergartens or even company's are looking for a way to make their premises free and flexible to create more space.

We have the solution. Our Table and Seating Systems are an excellent instrument for flexible interior design. In just a few minutes a single person can change a sitting room into a cafeteria, a cafeteria in an exercise room or a gym in an auditorium. All this is possible now without much effort and without back strain.

12 Seats	Size Open
MTSRH12K	366 x 146 cm
MTSRH12S	366 x 146 cm
MTSRH12E	366 x 146 cm



1



2



3



4



KG
Furniture

KG Furniture Storage Units

Flexo **New**
Acrylic
Ultimate
Comby
Elegance
Deluxe
Art Trolley **New**
Mobile book browser unit
Double sided book unit
Activity play table
Jackets hanger **New**



Flexo Storage Units

Our perfectly flexible storage units offer a lot of options and arrangements. All units are 40 cm deep to link them together and create a multitude of layouts with different heights. Designed empty to complete with storage wooden trays, or plastic trays (with anti-fall safety runners) . The shelves are extremely resistant and designed to support the weight of heavy books and objects. Made of Medium-density fiberboard (MDF) and melamine coated on both sides , doors coated by high pressure laminate (HPL) , with ABS edge banding . Available in single, double, triple and quadruple unit can be assembled upon request.

NEW

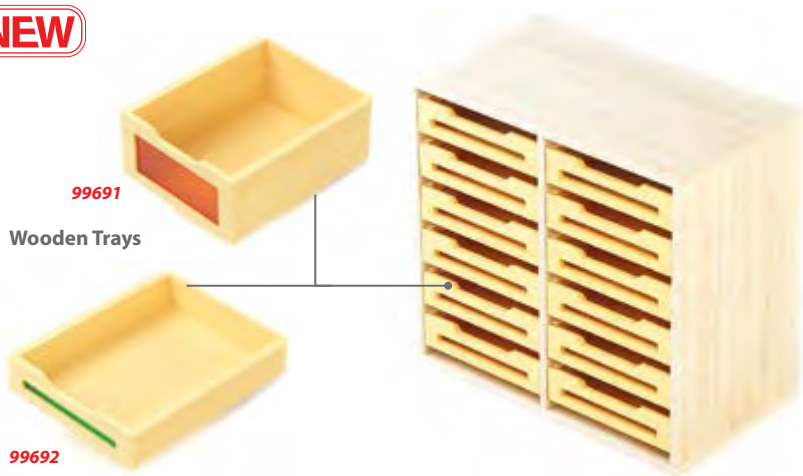

99691

Wooden Trays

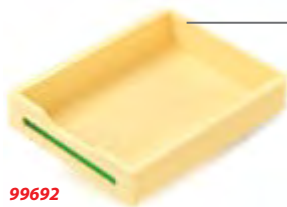

99692

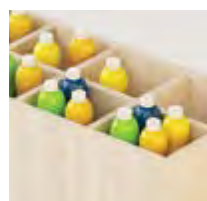

Easy-access bins for children



Plastic Trays

Colours



99695



99696

Trays Supplier



Made in UK



Doors HPL

Colours



KG Furniture



With or without casters
Height with casters + 12 cm
99697



With Steel base
Height steel base + 12 cm
99698

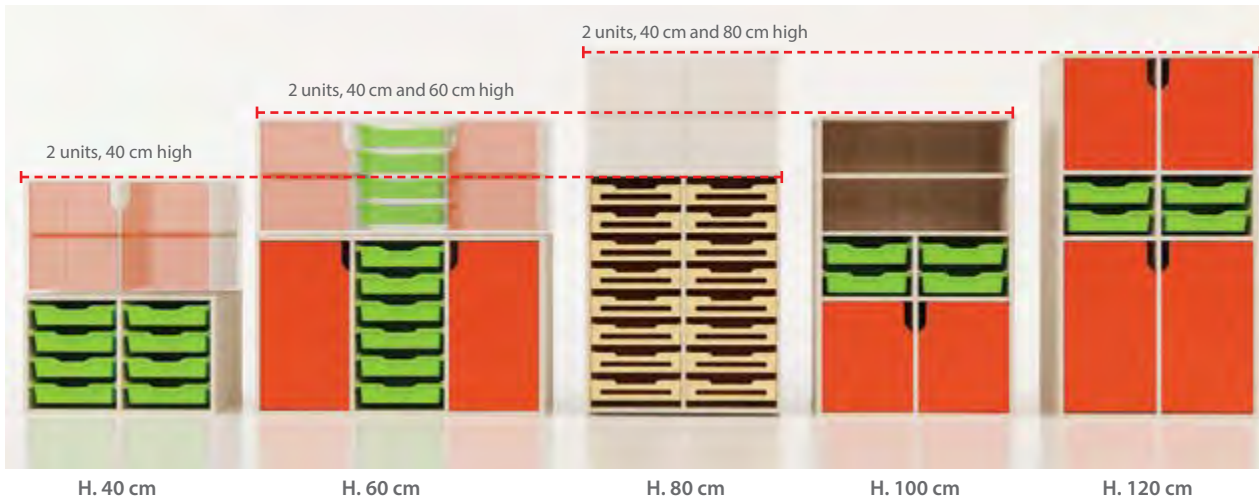

Wide range of heights & width

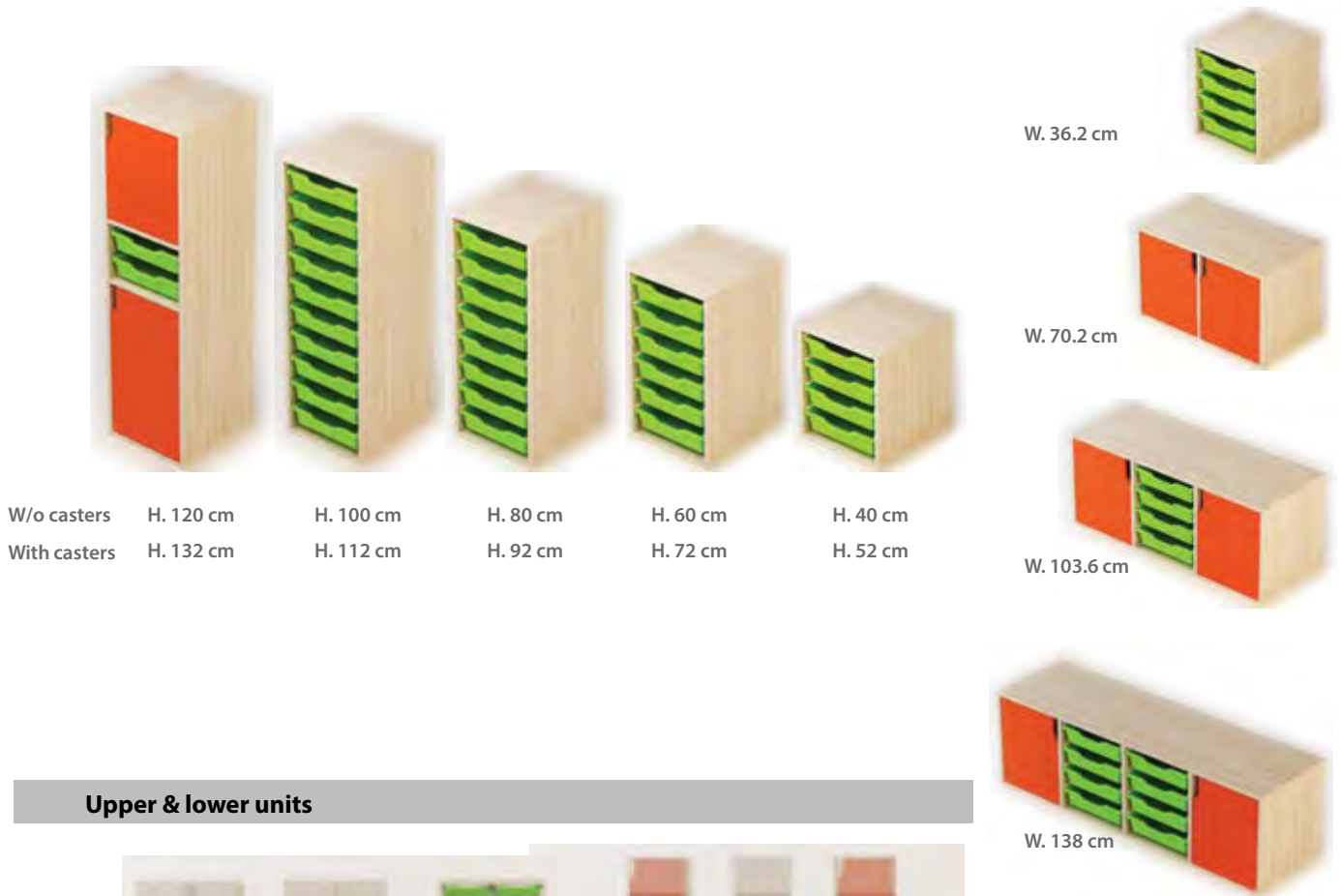



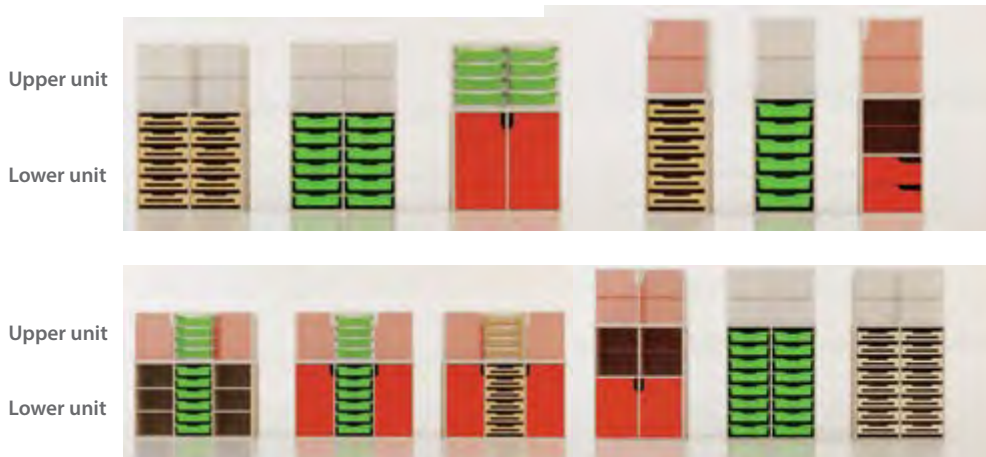











Upper & lower units



36.2 x 40 x 40 cm 6400	36.2 x 40 x 40 cm 6401	36.2 x 40 x 40 cm 6402	36.2 x 40 x 40 cm 6403
70.2 x 40 x 40 cm 6404	70.2 x 40 x 40 cm 6405	70.2 x 40 x 40 cm 6406	70.2 x 40 x 40 cm 6407
103.6 x 40 x 40 cm 6409	103.6 x 40 x 40 cm 6410	103.6 x 40 x 40 cm 6412	103.6 x 40 x 40 cm 6413
103.6 x 40 x 40 cm 6414	138 x 40 x 40 cm 6415	138 x 40 x 40 cm 6416	40 x 40 x 40 cm 6417

All item codes refers to the frame only.
To order:
1- Select frame code
2- Select base type code
3- Select drawer type code & quantity

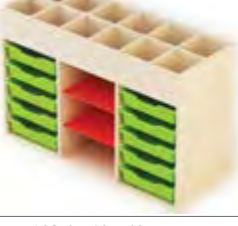
			
36.2 x 40 x 60 cm 64018	36.2 x 40 x 60 cm 64019	36.2 x 40 x 60 cm 64020	36.2 x 40 x 60 cm 64021
			
70.2 x 40 x 60 cm 64022	70.2 x 40 x 60 cm 64023	70.2 x 40 x 60 cm 64024	70.2 x 40 x 60 cm 64025
			
70.2 x 40 x 60 cm 64026	103.6 x 40 x 60 cm 64027	103.6 x 40 x 60 cm 64028	103.6 x 40 x 60 cm 64029
			
103.6 x 40 x 60 cm 64030	103.6 x 40 x 60 cm 64031	138 x 40 x 60 cm 64032	138 x 40 x 60 cm 64033
			
138 x 40 x 60 cm 64034	70.2 x 40 x 60 cm 64035	103.6 x 40 x 60 cm 64036	70.2 x 40 x 60 cm 64037
			
70.2 x 40 x 60 cm 64038	103.6 x 40 x 60 cm 64039	103.6 x 40 x 60 cm 64040	103.6 x 40 x 60 cm 64041

36.2 x 40 x 80 cm 64042	36.2 x 40 x 80 cm 64043	36.2 x 40 x 80 cm 64044	70.2 x 40 x 80 cm 64045
70.2 x 40 x 80 cm 64046	70.2 x 40 x 80 cm 64047	103.6 x 40 x 80 cm 64048	103.6 x 40 x 80 cm 64049
103.6 x 40 x 80 cm 64050	138 x 40 x 80 cm 64051	138 x 40 x 80 cm 64052	70.2 x 40 x 80 cm 64053
103.6 x 40 x 80 cm 64054	70.2 x 40 x 80 cm 64055	70.2 x 40 x 80 cm 64056	70.2 x 40 x 80 cm 64057
103.6 x 40 x 80 cm 64058	103.6 x 40 x 80 cm 64059	103.6 x 40 x 80 cm 64060	40 x 40 x 80 cm 64061

All item codes refers to the frame only.
 To order:
 1- Select frame code
 2- Select base type code
 3- Select drawer type code & quantity

			
36.2 x 40 x 100 cm 64062	36.2 x 40 x 100 cm 64063	36.2 x 40 x 100 cm 64064	36.2 x 40 x 100 cm 64065
			
36.2 x 40 x 100 cm 64066	70.2 x 40 x 100 cm 64067	70.2 x 40 x 100 cm 64068	70.2 x 40 x 100 cm 64069
			
70.2 x 40 x 100 cm 64070	70.2 x 40 x 100 cm 64071	70.2 x 40 x 100 cm 64072	70.2 x 40 x 100 cm 64073
			
70.2 x 40 x 100 cm 64074	70.2 x 40 x 100 cm 64075	70.2 x 40 x 100 cm 64076	70.2 x 40 x 100 cm 64077
			
70.2 x 40 x 100 cm 64078	103.6 x 40 x 100 cm 64079	103.6 x 40 x 100 cm 64080	103.6 x 40 x 100 cm 46081
			
138 x 40 x 100 cm 64082	138 x 40 x 100 cm 64083		

36.2 x 40 x 120 cm 64084	36.2 x 40 x 120 cm 64085	36.2 x 40 x 120 cm 64086	36.2 x 40 x 120 cm 64087
70.2 x 40 x 120 cm 64088	70.2 x 40 x 120 cm 64089	70.2 x 40 x 120 cm 64090	70.2 x 40 x 120 cm 64091
70.2 x 40 x 120 cm 64092	103.6 x 40 x 120 cm 64093	103.6 x 40 x 120 cm 64094	103.6 x 40 x 120 cm 64095
103.6 x 40 x 120 cm 64096	138 x 40 x 120 cm 64097	138 x 40 x 120 cm 64098	

All item codes refers to the frame only.
 To order:
 1- Select frame code
 2- Select base type code
 3- Select drawer type code & quantity



Acrylic Storage Units

The colorful acrylic back panels allow the light to shine through, giving charming effects. The unique curved design allows dynamic arrangements such as semicircular, circular and S shape. Modular units help creating a variety of combination possibilities. Made of an attractive combination of wood & acrylic. Great as a room divider. Available with coaster to give maximum flexibility in the educational space.

			
113.2 X 50.3 X 89.2 cm 45180	113.2 X 50.3 X 89.2 cm 45181	113.2 X 50.3 X 62.5 cm 45182	113.2 X 50.3 X 62.5 cm 45183
			
100 X 38 X 89.2 cm 45184	100 X 38 X 62.5 cm 45185		



Ultimate Storage Units

As well as looking attractive, this series of tray storage units are flexible and versatile. This collection was designed to fulfill the storage needs of any learning environment like KG Classrooms and art classroom. The wonderful colors of the trays & shelves give you the ability to make endless collections of colors to match your room design.

		 35 x 45 x 34 cm 45171	 70 x 45 x 34 cm 45172
 104 x 45 x 34 cm 45173	 35 x 45 x 60 cm 45160	 70 x 45 x 60 cm 45161	 70 x 45 x 60 cm 45162
 70 x 45 x 60 cm 45163	 104 x 45 x 60 cm 45164	 104 x 45 x 60 cm 45165	 104 x 45 x 60 cm 45166
 104 x 45 x 60 cm 45168	 104 x 45 x 60 cm 45169	 104 x 45 x 60 cm 45170	 104 x 45 x 60 cm 45177



Trays Supplier

Gratnells

Made in UK

Doors HPL Colours



Trays Colours



KG
Furniture

Comby Storage Units

A new range of storage units available in 2 versions: lower units and upper units. Some models are available with lower wooden boxes on wheels. These storage units are made of high quality non-scratch, washable, melamine coated, 18 mm thick M.D.F. They come in beech wood patterned melamine with rounded-off rimmed thick plastic edges. Doors and drawers are made of natural beech wood and painted with non-toxic paints.

<p>Upper unit</p>  <p>103.3 x 40 x 60 cm 45503</p>	<p>Upper unit</p>  <p>103.3 x 40 x 60 cm 45504</p>	<p>Upper unit</p>  <p>103.3 x 40 x 60 cm 45505</p>	<p>Upper unit</p>  <p>103.3 x 40 x 60 cm 45506</p>
<p>Lower unit</p>  <p>40 x 40 x 90 cm 45550</p>	<p>Lower unit</p>  <p>40 x 40 x 90 cm 45551</p>	<p>Lower unit</p>  <p>103.3 x 40 x 90 cm 45520</p>	<p>Lower unit</p>  <p>103.3 x 40 x 90 cm 45521</p>



<p>Lower unit</p>  <p>103.3 x 40 x 90 cm 45522</p>	<p>Lower unit</p>  <p>103.3 x 40 x 90 cm 45523</p>	<p>Lower unit</p>  <p>103.3 x 40 x 90 cm 45524</p>	<p>Lower unit</p>  <p>103.3 x 40 x 90 cm 45525</p>
<p>Lower unit</p>  <p>103.3 x 40 x 90 cm 45526</p>	<p>Lower unit</p>  <p>103.3 x 40 x 90 cm 45527</p>	<p>Lower unit</p>  <p>103.3 x 40 x 90 cm 45528</p>	<p>Lower unit</p>  <p>103.3 x 40 x 90 cm 45540</p>
<p>Lower unit</p>  <p>103.3 x 40 x 90 cm 45541</p>	<p>Lower unit</p>  <p>103.3 x 40 x 90 cm 45542</p>	<p>Lower unit</p>  <p>103.3 x 40 x 90 cm 45543</p>	<p>Lower unit</p>  <p>103.3 x 40 x 90 cm 45544</p>
<p>Lower unit</p>  <p>103.3 x 40 x 90 cm 45545</p>	<p>Lower unit</p>  <p>103.3 x 40 x 90 cm 45546</p>	<p>Lower unit</p>  <p>103.3 x 40 x 90 cm 45547</p>	<p>Lower unit</p>  <p>103.3 x 40 x 90 cm 45548</p>



Doors HPL Colours



KG
Furniture

Elegance Storage Units

The simple and functional designs of our collection of modular units offer perfect solutions for your storage problems. Available in 7 different designs and sizes to suit your needs.

80 x 40 x 100 cm 45619	80 x 40 x 100 cm 45617	80 x 40 x 100 cm 45616	80 x 40 x 140 cm 45615
80 x 40 x 140 cm 45614	80 x 40 x 180 cm 45612	80 x 40 x 180 cm 45613	80 x 40 x 220 cm 45611

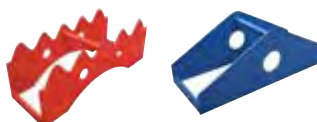

Deluxe Storage Units

This is our deluxe series of a wide and unique selection of high quality storage classroom furniture. We provide an unparalleled range of superior storage units with a strong focus on kid happiness, teacher satisfaction and child safety. These storage systems will keep your classroom organized. Removable shelves for more room. Wipe clean surface & colourful doors.



Equipment trolley

This Multi-function storage trolley is ideal for all organizing materials and resources. It is equipped with shelves, plastic trays and wooden trays which allows storage of games and educational materials. Coasters can be added to give the ability to move recourses from area to area. Made of high quality MDF.

			
		70.2 x 40 x 72 cm 64038	70.2 x 40 x 72 cm 64037
			
103.6 x 40 x 72 cm 64039	103.6 x 40 x 72 cm 64040	103.6 x 40 x 72 cm 64041	70.2 x 40 x 92cm 64055
			
103.6 x 40 x 92 cm 64058	103.6 x 40 x 92 cm 64059	70.2 x 40 x 92cm 64056	70.2 x 40 x 92cm 64057
	<i>Island unit</i> 	<i>Island unit</i> 	<i>Island unit</i> 
103.6 x 40 x 92 cm 64060	103.6 x 40 x 92 cm 64102	70.2 x 40 x 92cm 64103	70.2 x 40 x 92cm 64104
			
Rover Trolley GR			



Mobile Book Browser Units Rack

Each unit features easy-access bins for children to choose and pick books. Available in 3 designs: two bins, four bins, four bins with drawers. Supplied assembled.



35.6 x 45 x 37 cm **45152**



69.4 x 45 x 37 cm **45153**



69.4 x 45 x 60 cm **45151**

Double Sided Display Book Unit

In these units you can display the books on both sides. There are two levels for the shelves. There are two types, one with two drawers and the second with three drawers. Suitable for books and magazines. Supplied assembled.



103.2 x 45 x 120 cm **45155**



69.4 x 45 x 90 cm **45154**



80 x 40 x 100 cm **45157**



80 x 40 x 60 cm **45158**

Activity play table

This table is designed specially for play. The stand-up working height makes it perfect for play time. Its colorful silk-screened landscape board was built to last. Curved edges for safety. Transparent plastic drawers for easy storage of toys. It can be used from all sides for group play.



NEW 116 x 78 x 40 cm **45187**



NEW 116 x 78 x 56 cm **45188**



NEW 75 x 75 x 40 cm **45189**



NEW 75 x 75 x 56 cm **45190**

Coat locker unit

These sturdy units provide convenient storage space for organizing classrooms. It is available in double, triple and quadruples units. Each unit contains 2 plastic trays with anti-fall safety runners included. Also it can be equipped with shelf for shoes. Made of high quality MDF.



NEW 70.2 x 40 x 112 cm **64099**



NEW 103.6 x 40 x 112 cm **64100**



NEW 138 x 40 x 112 cm **64101**

KG Furniture **Accessories** for Kindergarten



Reading Centers
Play Corners
Playing Platforms
Puppet Theater
Wooden Fences
Pretend Play
Children Lounge & Carpets
Easel & Play Screen
Boards
Bean Bags





Reading Centers

These cleverly designed reading centres are very inviting to children that they'll need no one else to encourage them to read!! Each unit features easy-access bins and comfy, carpeted seating where kids can sit, relax and enjoy reading. Available in 3 cheerful designs-boat, car or train. Features knock-down design. Supplied unassembled

		
<p>110x 83.6 x 95.3 cm Boat - 41130</p>	<p>120 x 83.6 x 80.5 cm Train - 41131</p>	<p>105 x 83.6 x 108 cm Car - 41132</p>



Curved Storage Box Units

These smooth designed storage units are very helpful for reading corners. Its curved back and module design are ideal for making different corners depending on the space available. Supplied assembled.

91.8 x 36.9 x 81.6 cm **45150**



Play Platforms

These platforms are available in 7 shapes in 3 different heights. The varying heights encourage movements for little children. Also It can be used as a playing corner. Handles are available to move and carry easily. High units have a tunnel system to add more fun for toddlers to crawl under. Surfaces are covered with heavy-duty carpets or a safe mirror.



75 X 75 X 30 cm 45960	75 X 75 X 15 cm 45961	75 X 75 X 15 cm 45962	112.5 X 75 X 45 cm 45963
75 X 37.5 X 15 cm 45964	75 X 75 X 15 cm 45965	75 X 75 X 15 cm 45966	75 X 75 X 45 cm 45967



Play Corner

An enjoyable play centre where a child can enter the world of imagination and act out different roles in these shop, theatre and kitchen units.

Code 45950

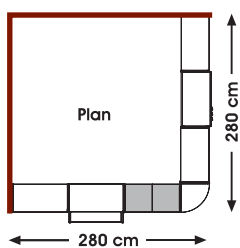

KG
Furniture

Stage

Stage is a high quality modular staging system that is light, robust, well finished and exceptionally easy to assemble. It's been designed in conjunction with the UK's leading portable stage designer and brings you the best quality available in modular staging and the most versatile system. The clever engineering gives you a sturdy stage system that's so simple to assemble that a child can do it, while providing a strong platform for your performances. You can use it however you need to make the most of your space and time, pack it away and then re-use it for an entirely different purpose.



KG Furniture

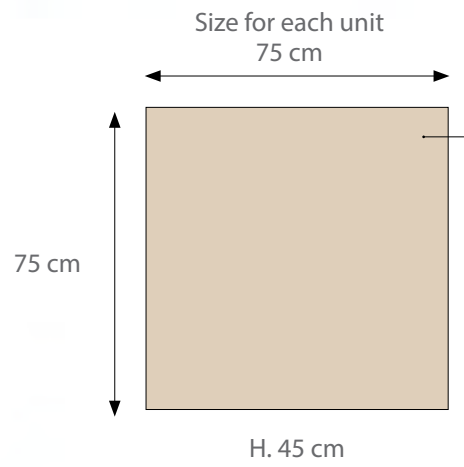

KG
Furniture

Kitchen

Our kitchen set will make your drama corner the most attractive in town! In this kitchen set we have combined play value with the highest quality, durability and, of course, value for money. There are two new types:

- One unit kitchen
- Separated units kitchen (3 units)

<p>33 x 40 x 85 cm Fridge - 21616</p>	<p>40 x 40 x 52 cm Washing Machine & Sink - 21606</p>	<p>40 x 40 x 52 cm Cooker - 21601</p>				
<p>112 x 40 x 105 cm One Unit Pretend Kitchen (Fridge - Washing Machine & Sink - cooker) - 21660</p>						
<table border="1"> <tr> <td data-bbox="105 1467 1015 2072"> </td> <td data-bbox="1015 1467 1469 2072"> </td> </tr> <tr> <td data-bbox="105 2072 1015 2134"> <p>Fun pretend Clothes rack - 21570 55.3 x 34 x 55.3 cm</p> </td> <td data-bbox="1015 2072 1469 2134"> <p>Fun pretend Iron set - 21565 82.5 x 28 x 55 cm</p> </td> </tr> </table>					<p>Fun pretend Clothes rack - 21570 55.3 x 34 x 55.3 cm</p>	<p>Fun pretend Iron set - 21565 82.5 x 28 x 55 cm</p>
<p>Fun pretend Clothes rack - 21570 55.3 x 34 x 55.3 cm</p>	<p>Fun pretend Iron set - 21565 82.5 x 28 x 55 cm</p>					

Puppet Theater

Our attractive Theatres invites your child to put on a show the audience will never forget. The wooden design features a sturdy, non-tip base to protect your child and the audience, and there is plenty of room inside for a puppeteer or two

		
<p>91 x 35 x 167 cm modern - 21560</p>	<p>68 x 40 x 136 cm elegance - 21555</p>	<p>94 x 33.5 x 137 cm classic - 21500</p>

Wooden Fences

Fun & functional!! These charming, beech wood "fences" will help organize play rooms, classrooms, or libraries into functional areas to better utilize space. Fences easily link together with movable safety wooden hinges to form different formations.

130 x 110 cm

41120



KG
Furniture

Easel & Play screen

Children will have lots of fun playing with these play screens. There are two sizes. The smaller size has a chalkboard, white board, transparent board and giant abacus. The larger size has a chalkboard, transparent board, giant abacus and puppet theatre.



Teaching Easel

69.5 x 50 x 161 cm **TR**



Double Sided Metal Easel with Trays

108 x 42 x 140 cm **21520**



Double Sided Wooden Easel with Trays

70 x 45 x 120 cm **21521**



Colourful Easel

68 x 4.5 x 106 cm **21580**



Double sided Easel

63 x 10 x 120 cm **21510**



Double sided easel

41 x 5 x 95 cm **21505**



Play screen

46 x 11.5 x 69 cm **21515**



Play screen

77 x 12 x 135.5 cm **21540**

Boards

Our variety of boards of different materials and sizes to meet your requirements and budget. Our wall mounted whiteboards and chalkboards are constructed with one of three materials; melamine resin which can be your best option when your budget is limited or polyester coated steel and enamelled steel which is more durable than the other materials and can last for long years. Wall mounted pin boards with aluminum frame. Pin boards are available with Natural cork. Different sizes are available.



Ceramic steel surface magnetic with wood frame	size
Wo 42105	120 x 240 cm
Wo 42115	120 x 80 cm



Chalk board with wood frame	size
Wo 42185	120 x 240 cm
Wo 42195	120 x 80 cm



Pin board with Aluminum frame	size
AL 42171	120 x 80 cm
AL 42172	80 x 60 cm
AL 42175	60 x 40 cm



Bean Bags

Attractive comfortable bean bags that is ideal for free seating in schools, universities and activity centers.



Chilling Bag Lounge

The SCHUKI Chilling Bags are one of the most comfortable seats available. Thanks to their robust and hard-wearing outer sheath, they are ideal for everyday life in school, kindergarten. It comes in a variety of colors and sizes e.g.

In addition, all seat bags are made of a water-repellent fabric. Liquids such as coffee, tea or juices simply won't pass through the fabric and can easily be wiped off with a cloth. Also outer cover can be removed by zipper and washed at 30 degrees.

The filling consists of small polystyrene beads that are sewn into a tear-resistant inner bag. The SCHUKI Chilling beanbags can be used safely on the ground, whether inside or outside, both ambiance cold and hot...

Advantages at a glance:

- Tear resistant outer shell
- Outdoor-capable
- Water-repellent



Würfel

The cube Shape has the same characteristics like the model series. Comfortable seat cushion cube in shape, which can be used very well in group learning or also in sports lessons.

Size: 40 x 40 x 40 cm



Hocker

Hocker SBM CBH are one of the most comfortable seats available. Thanks to their robust and hard-wearing outer sheath, they are ideal for everyday life in school, kindergarten; It comes in a variety of colors and sizes e.g. In addition, all seat bags are made of a water-repellent fabric. Liquids such as coffee, tea or juices simply won't pass through the fabric and can easily be wiped off with a cloth. Also outer cover can be removed by zipper and washed at 30 degrees.

The filling consists of small polystyrene beads that are sewn into a tear-resistant inner bag. The SCHUKI Chilling beanbags can be used safely on the ground, whether inside or outside, both ambiance cold and hot...

Advantages at a glance:

- Tear resistant outer shell
- Outdoor-capable
- Water-repellent



KG Furniture

Insel

Insel – SBM CBI are one of the most comfortable seats available. Thanks to their robust and hard-wearing outer sheath, they are ideal for everyday life in school, kindergarten; It comes in a variety of colors and sizes e.g.

In addition, all seat bags are made of a water-repellent fabric. Liquids such as coffee, tea or juices simply won't pass through the fabric and can easily be wiped off with a cloth. Also outer cover can be removed by zipper and washed at 30 degrees.

The filling consists of small polystyrene beads that are sewn into a tear-resistant inner bag. The SCHUKI Chilling beanbags can be used safely on the ground, whether inside or outside, both ambiance cold and hot...

Advantages at a glance:

- Tear resistant outer shell
- Outdoor-capable
- Water-repellent



Advantages :



All Schuki models have one Highly water resistant outer shell. Liquids like coffee, tea or Juices simply peel off the fabric, and can Easily with a soft cloth Wiped out.

Our Schuki Chilling Bags are also included The most comfortable seating there is gives. We have 7 models that are in different styles Way. The extreme Robust, durable and tear resistant The outer sleeve can be removed by means of a zipper And washed

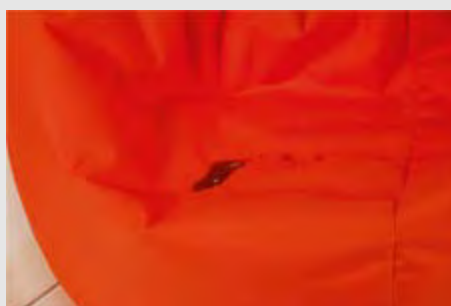

The filling is 100% made of high-quality, Practically dust-free EPSPerlen (Polystyrene), which is incorporated into a safe Inner bag. By the good Insulating effect you can use the Seat bags, whether inside or outside, Comfortable to use on the floor. A cold is excluded

KG
Furniture



KG Furniture

Natural Line

EDU FUN welcomes you to its new section, which provides new furniture collections with natural look. Practical, suitable and comfortable designs are offered to fulfill the demands of children in their early years. Many educators believe in the importance of neutralizing the working space for children to concentrate on learning process. Our natural look furniture is also suitable for Montessori classes, as it is compatible with its philosophy.





Star Chair

New ultra modern design, manufactured with a high quality beech wood frame. Ergonomically shaped back & seat give maximum comfort & ease of use. Seats are available in 2 sizes.



Woody Chair

These chairs are perfect companions to our wooden student desks (Elegance-Classic). Chairs have ergonomic designs and provide proper back support. Children can easily move these light chairs around. Seats are available in 2 sizes.



Curvy Woody Chair

This curved woody chair combines the durability of the woody chair with curved edges for softer look. The ergonomic designs provide proper back support. It is suitable for children to move these chairs around. Seats are available in 2 sizes.



C2 H.31 cm - 29.5x37.5 cm - 48120	C2 H.31 cm - 30x32 cm - 43215	C2 H.31 cm - 32x32 cm - 43107
C3 H.35 cm - 29.5x37.5 cm - 48121	C3 H.35 cm - 30x32 cm - 43216	C3 H.35 cm - 32x32 cm - 43109



Leg-tips have plastic caps to prevent noise & marring of floor surface when moved.



Safe rounded corners

Classic Plus Chair

Natural beech wood with HQ finishes, this very light and sturdy design offers durability and ease of movement. The birch plywood seats are available in 4 heights.



Classic Chair

Top quality chairs that will last for generations. These Classic chairs are made with a solid beech wooden frame, strong enough for even an adult to stand on. Seats are laminated MDF board.



ST

Classic S Chair

This chair combines all the advantages of the classic chair in addition of stacking. Top quality, chair that will last for generations. The frame is made of solid beech wooden and seat is made from laminated MDF boards. It is one of the best durable strong chairs that can bear for an adult to stand on.



C0 H. 22 cm - 28.5 x 28.5 cm - **43120**

C1 H. 26 cm - 28.5 x 28.5 cm - **43121**

C2 H. 31 cm - 30 x 30 cm - **43122**

C3 H. 35 cm - 30 x 30 cm - **43123**

C0 H. 22 cm - 28.5 x 28.5 cm - **43115**

C1 H. 26 cm - 28.5 x 28.5 cm - **43116**

C2 H. 31 cm - 30 x 30 cm - **43117**

C3 H. 35 cm - 30 x 30 cm - **43118**

C0 H. 22 cm - 33 x 30 cm - **43140**

C1 H. 26 cm - 33 x 30 cm - **43141**

C2 H. 31 cm - 35 x 30 cm - **43142**

C3 H. 35 cm - 35 x 30 cm - **43143**



Leg-tips have plastic caps to prevent noise & marring of floor surface when moved.

Natural beech wood structure

ST

Deluxe Chair

More ergonomic colourful chairs that will last for generations. Each chair is made of solid, top-quality lacquered beech wood & plywood. Available in 3 different heights. Available with arms.

ST

Elegance Chair

These beautifully crafted stackable chairs would look great in any classroom. Each chair is made of solid, top-quality lacquered beech wood and is built to last. Two convenient seat heights are available to correspond with Elegance tables. Available with arms.

Elegance Stool

This stool is made of solid Beech wood frame and laminated plywood seat. No sharp corners so children won't catch toes or clothes. The neutral tone makes it compatible with many tables. Gentle to the floor Doweled plastic glides even after years of use. Its construction assures strength, stability and support.



		C0 H. 22 cm - 32x33 cm - 43330
C2 H. 31 cm - 26x27.5 cm - 43280	C2 H. 31 cm - 30x25.5 cm - 43203	C1 H. 26 cm - 32x33 cm - 43331
C3 H. 35 cm - 28.5x31 cm - 43285	C3 H. 35 cm - 30x25.5 cm - 43204	C2 H. 31 cm - 32x33 cm - 43332
		C3 H. 35 cm - 32x33 cm - 43333



ST**Premium chair**

The ergonomic chair design makes it comfortable and encourages children to sit properly. It is sturdy, durable and practical. It is constructed with premium formed metal pipes, seat and back from plywood. Round glides for hard and soft floors.

**ST****Simple Chair**

Sturdy, durable & light chairs. Constructed with superior formed metal pipes, seat and back from environmental-friendly plywood for comfort seating. Two heights suitable for Curvy & Soft table sets.

**ST****Simple S Chair**

Durable, comfortable and light chairs. Constructed with premium formed metal pipes. Seat and back are made from multiple-layer plywood. The large front seating edge supports good posture. The doweled plastic glides are gentle to the floor even after years of use. Chair is stackable up to 6 chairs.



C2 H.31 cm - 34x44 cm - **43518**

C3 H.35 cm - 34x44 cm - **43519**

C2 H.31 cm - 34x44 cm - **43505**

C3 H.35 cm - 34x44 cm - **43506**

C2 H.31 cm - 35x32 cm - **48433**

C3 H.35 cm - 35x32 cm - **48434**



NEW

Flexo Tables

These flexible movable Creative tables combines contemporary looks, functionality as well as flexibility encourage social behavior, creativity and cooperation among students. It comes in a variety of unique shapes; sizes, each shape and size have its merits and benefits, depending on the learning situation. Tables can be combined with each other or with other tables combining multitude of layouts creating an attractive look. Made of Medium-density fiberboard (MDF) covered by high pressure laminate (HPL), with ABS edge banding .Legs available fixed or adjustable to offer different heights, which can be an advantage for mixed age groups.

C0... Nursery1
 C1... Nursery2
 C2... K.G 1
 C3... K.G 2



KG Furniture



Flexo table		Flexo table		Flexo table	
					
					
multi H. - 44701		multi H. - 44705		multi H. - 44709	
C2 H. 53 cm - 120x120 cm - 44700		C2 H. 53 cm - 180x120 cm - 44704		C2 H. 53 cm - 130x120 cm - 44708	
C3 H. 59 cm - 120x120 cm - 44702		C3 H. 59 cm - 180x120 cm - 44706		C3 H. 59 cm - 130x120 cm - 44710	
Flexo table		Flexo table		Flexo table	
					
					
multi H. - 44713		multi H. - 44717		multi H. - 44721	
C2 H. 53 cm - 80x80 cm - 44712		C2 H. 53 cm - 120x120 cm - 44716		C2 H. 53 cm - 105x105 cm - 44720	
C3 H. 59 cm - 80x80 cm - 44714		C3 H. 59 cm - 120x120 cm - 44718		C3 H. 59 cm - 105x105 cm - 44722	
Flexo table					
					
					
multi H. - 44725					
C2 H. 53 cm - 90x80 cm - 44724					
C3 H. 59 cm - 90x80 cm - 44726					

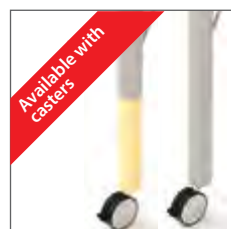

Available with casters

With Casters



Recommended Chairs

Simple S

Multi Tables

NEW

Activity table, one of the most versatile furnishings that are important for enhancing the learning environment for students. It comes in a variety of unique shapes, sizes, and colours making them ideal solution for student collaboration and interaction in today's multi-zone learning environments. It is a height adjustable tables features a high-pressure laminate surface for long lasting use. Made of Medium-density fiberboard (MDF) covered by high pressure laminate (HPL), with ABS edge banding. Legs available fixed or adjustable to offer different heights, which can be an advantage for mixed age groups.

- C0... Nursery1
- C1... Nursery2
- C2... K.G 1
- C3... K.G 2



KG Furniture



Multi table		Multi table		Multi table	
					
multi H. - 44729		multi H. - 44733		multi H. - 44737	
C2 H. 53 cm - 100x95 cm - 44728 C3 H. 59 cm - 100x95 cm - 44730		C2 H. 53 cm - 120x60 cm - 44732 C3 H. 59 cm - 120x60 cm - 44734		C2 H. 53 cm - 120x120 cm - 44736 C3 H. 59 cm - 120x120 cm - 44738	
Multi table		Multi table		Multi table	
					
multi H. - 44741		multi H. - 44745		multi H. - 44749	
C2 H. 53 cm - 180x78 cm - 44740 C3 H. 59 cm - 180x78 cm - 44742		C2 H. 53 cm - 120x80 cm - 44744 C3 H. 59 cm - 120x80 cm - 44746		C2 H. 53 cm - 120x80 cm - 44748 C3 H. 59 cm - 120x80 cm - 44750	
Multi table		Multi table		Multi table	
					
multi H. - 44753		multi H. - 44757		multi H. - 44761	
C2 H. 53 cm - 180x120 cm - 44752 C3 H. 59 cm - 180x120 cm - 44754		C2 H. 53 cm - ø 100 cm - 44756 C3 H. 59 cm - ø 100 cm - 44758		C2 H. 53 cm - ø 90 cm - 44760 C3 H. 59 cm - ø 90 cm - 44762	



Available with casters

With Casters



Recommended Chairs

Simple S

KG Furniture

Elegance Tables

Our lines of Elegance Tables come packed-flat for your convenience. The tables are easily assembled with the simple instructions provided. When correctly assembled, our tables are solid, stable and durable. Tables come in 4 convenient heights and table-tops are available in 11 functional shapes. All our tables are modular, so they can be arranged in many different configurations. Tables have laminated M.D.F table-tops with clear lacquered beech wood frames.

- C0... Nursery1
- C1... Nursery2
- C2... K.G 1
- C3... K.G 2



<p>Elegance - Rectangular Table</p>  <p>4</p> <p>C0 H. 40 cm - 60x80 cm - 44321 C1 H. 46 cm - 60x80 cm - 44322 C2 H. 53 cm - 60x80 cm - 44323 C3 H. 59 cm - 60x80 cm - 44324</p>	<p>Elegance - Rectangular Table</p>  <p>6</p> <p>C0 H. 40 cm - 120x60 cm - 44331 C1 H. 46 cm - 120x60 cm - 44332 C2 H. 53 cm - 120x60 cm - 44333 C3 H. 59 cm - 120x60 cm - 44334</p>	<p>Elegance - Semi-Circular Table</p>  <p>3</p> <p>C0 H. 40 cm - 120x60 cm - 44511 C1 H. 46 cm - 120x60 cm - 44512 C2 H. 53 cm - 120x60 cm - 44513 C3 H. 59 cm - 120x60 cm - 44514</p>
<p>Elegance - Circle Table</p>  <p>4</p> <p>C0 H. 40 cm - ø 120 cm - 44410 C1 H. 46 cm - ø 120 cm - 44411 C2 H. 53 cm - ø 120 cm - 44412 C3 H. 59 cm - ø 120 cm - 44413</p>	<p>Elegance - Circle Table</p>  <p>2</p> <p>C0 H. 40 cm - ø 90 cm - 44415 C1 H. 46 cm - ø 90 cm - 44416 C2 H. 53 cm - ø 90 cm - 44417 C3 H. 59 cm - ø 90 cm - 44418</p>	<p>Elegance - Trapezoidal Table</p>  <p>3</p> <p>C0 H. 40 cm - 120x52 cm - 44201 C1 H. 46 cm - 120x52 cm - 44202 C2 H. 53 cm - 120x52 cm - 44203 C3 H. 59 cm - 120x52 cm - 44204</p>
<p>Elegance - Octagonal Table</p>  <p>8</p> <p>C0 H. 40 cm - ø 120 cm - 44685 C1 H. 46 cm - ø 120 cm - 44686 C2 H. 53 cm - ø 120 cm - 44687 C3 H. 59 cm - ø 120 cm - 44688</p>	<p>Elegance - Triangle Table</p>  <p>4</p> <p>C0 H. 40 cm - 60x120 cm - 44675 C1 H. 46 cm - 60x120 cm - 44676 C2 H. 53 cm - 60x120 cm - 44677 C3 H. 59 cm - 60x120 cm - 44678</p>	<p>Elegance - U shape Table</p>  <p>5-6</p> <p>C0 H. 40 cm - 180x120 cm - 44670 C1 H. 46 cm - 180x120 cm - 44671 C2 H. 53 cm - 180x120 cm - 44672 C3 H. 59 cm - 180x120 cm - 44673</p>
<p>Elegance - Rectangular Table</p>  <p>6</p> <p>C0 H. 40 cm - 120x80 cm - 44680 C1 H. 46 cm - 120x80 cm - 44681 C2 H. 53 cm - 120x80 cm - 44682 C3 H. 59 cm - 120x80 cm - 44683</p>	<p>Elegance - Square Table</p>  <p>2</p> <p>C0 H. 40 cm - 60x60 cm - 44690 C1 H. 46 cm - 60x60 cm - 44691 C2 H. 53 cm - 60x60 cm - 44692 C3 H. 59 cm - 60x60 cm - 44693</p>	

Curvy Tables

Well - designed Curvy tables can handle any activity & wide range of shapes makes Curvy tables can suite various numbers of children. The legs height can be adjusted with just an easy turn in the screw & table-top is covered wirh formica.

C0... Nursery1
 C1... Nursery2
 C2... K.G 1
 C3... K.G 2



<p>Curvy - Square Table</p>  <p> 2</p> <p>60x60 cm - 44440</p>	<p>Curvy - Rectangular Table</p>  <p> 6</p> <p>120x60 cm - 44443</p>	<p>Curvy - Long Table</p>  <p> 8</p> <p>160x60 cm - 44445</p>
<p>Soft - Square Table</p>  <p> 2</p> <p>60x60 cm - 44441</p>	<p>Soft - Rectangular Table</p>  <p> 6</p> <p>120x60 cm - 44444</p>	<p>Soft - Long Table</p>  <p> 8</p> <p>160x60 cm - 44446</p>
<p>Curvy - Semi-circular Table</p>  <p> 6</p> <p>120x180 cm - 44449</p>	<p>Curvy - Kidney Table</p>  <p> 6</p> <p>120x180 cm - 44610</p>	<p>Curvy - Circle Table</p>  <p> 6</p> <p>ø 120 cm - 44447</p>
<p>Curvy - Quarto circle Table</p>  <p> 4</p> <p>80x170 cm - 44448</p>	<p>Curvy - Rosy Table</p>  <p> 6</p> <p>ø 120 cm - 44430</p>	<p>Curvy - Semi Quarto circle Table</p>  <p> 3</p> <p>60x100 cm - 44461</p>

Furniture
KG

NEW

Flexo Storage Units

Our perfectly flexible storage units offer a lot of options and arrangements. All units are 40 cm deep to link them together and create a multitude of layouts with different heights. Designed empty to complete with storage wooden trays, or plastic trays (with anti-fall safety runners) . The shelves are extremely resistant and designed to support the weight of heavy books and objects. Made of Medium-density fiberboard (MDF) and melamine coated on both sides , doors coated by high pressure laminate (HPL) , with ABS edge banding . Available in single, double, triple and quadruple unit can be assembled upon request.



99691

Wooden Trays



99692



99693

Rattan Trays



99694



99695

Plastic Trays available colors



99696

Trays Supplier



Made in UK

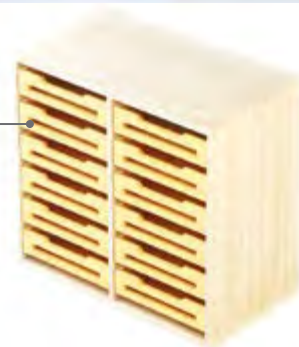

KG Furniture























With or without casters
Height with casters + 12 cm

99697

With Steel base
Height steel base + 12 cm

99698

			
36.2 x 40 x 40 cm 64000	36.2 x 40 x 40 cm 64001	70.2 x 40 x 40 cm 64006	70.2 x 40 x 40 cm 64004
			
<i>Front</i>	<i>Back</i>		
70.2 x 40 x 40 cm 64005	Double-sided	103.6 x 40 x 40 cm 64010	36.2 x 40 x 60 cm 64019
			
70.2 x 40 x 60 cm 64022	<i>Front</i>	<i>Back</i>	103.6 x 40 x 60 cm 64027
	70.2 x 40 x 60 cm 64035		
			
103.6 x 40 x 60 cm 64028	138 x 40 x 60 cm 64032	36.2 x 40 x 80 cm 64042	70.2 x 40 x 80 cm 64045
			
<i>Front</i>	<i>Back</i>		
70.2 x 40 x 80 cm 64053		70.2 x 40 x 100 cm 64067	70.2 x 40 x 100 cm 64077

All item codes refers to the frame only.
 To order:
 1- Select frame code
 2- Select base type code
 3- Select drawer type code & quantity



Safety Products

The children's safety is an obligation for everyone who works or deals with children. We are always looking for creating a safer environment for children. At schools, kindergartens, child daycare, playing centers and everywhere children are there; safety is a must. An accident can happen at any place at any time. However, with safety products we are building a safer world for children and preventing painful and serious accidents to happen.





22081

Anti Slip Steps ▶

The colored Anti-slip Steps prevent slipping on slippery floors or stairs. Children are often busy playing, and thus, not recognizing hazards. Running over a wet floor can therefore end in a nasty fall. These anti-slip stickers feature a robust coating that provides grip to prevent accidents. The colored feet create a safer environment and also function as a mark on the floor and stairs. The anti-slip feet are playful and stimulate the attention of children.

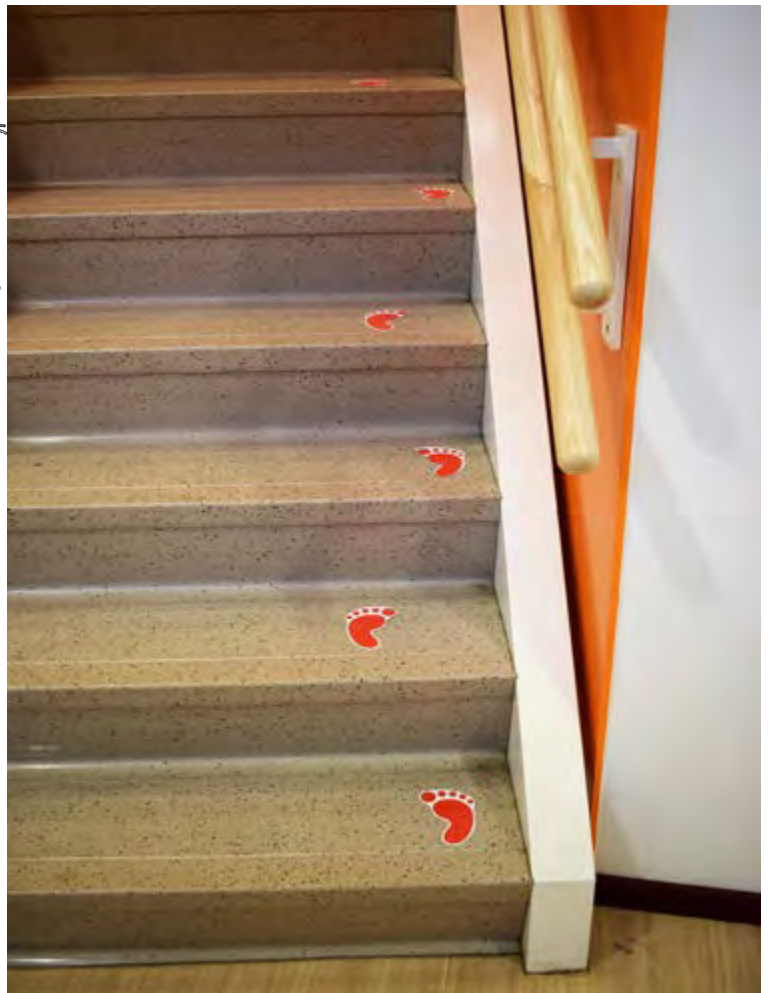

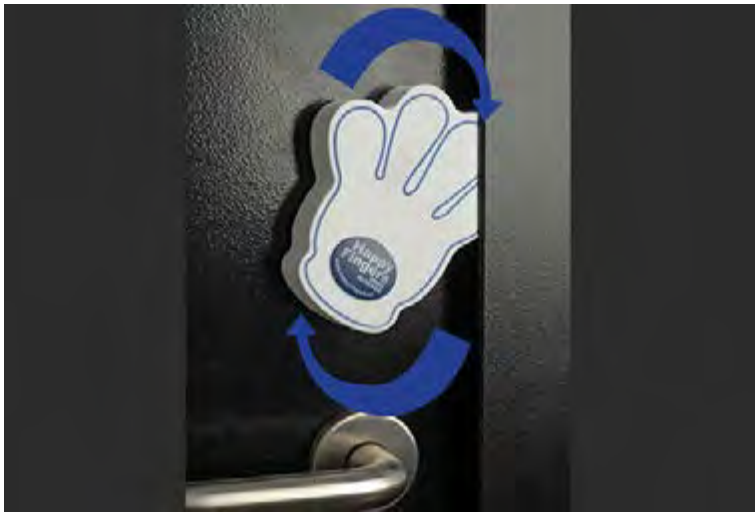

◀ Finger Alert Door Blocker

The Finger Alert Door Blocker is a simple but effective solution against finger entrapment. Make doors safer by attaching this door blocker over the door handle. Turn the door buffer in horizontal position and prevent a door from closing. Close the door by turning the hand in a vertical position. This finger protection for doors is easy to install, saving you a lot of time and accidents. This cheerful hand against finger entrapment is the ideal complement for child-proofing doors.



Door stopper ▶

Stop doors temporarily with this cute red foot. The Finger Alert Door Stopper keeps the door from slamming and prevents painful and serious injuries to the fingers of children.



Finger Alert 110° ▶

Prevents fingers from getting pinched between the door and doorframe by using the Finger Alert door finger guards! It is a quick and child safe solution to cover gaps between doorframes and doors. These door strips fit all doors and frames because of the transparent material. Cover door openings of doors that open up to 110° easily with these transparent finger door guards. Happy fingers with Finger Alert!

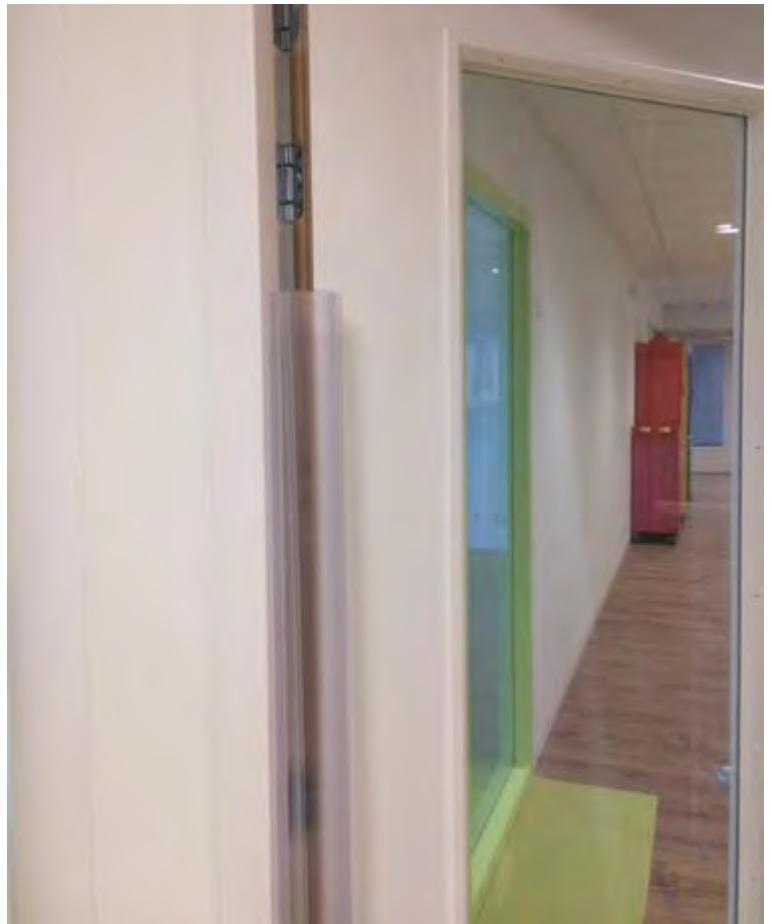

The Finger Alert 170-180°

Specially designed for schools, kindergartens and public buildings as sustainable door protection. This professional door strip eliminates the risk that inattentive children get their fingers stuck between the doors on the hinge side. This professional door finger protector absorbs the heaviest blows and lasts for years. Along with our other solutions, such as the Finger Alert Door Blocker and Finger Alert Door Stopper, you create a carefree environment for children where they can play safely.

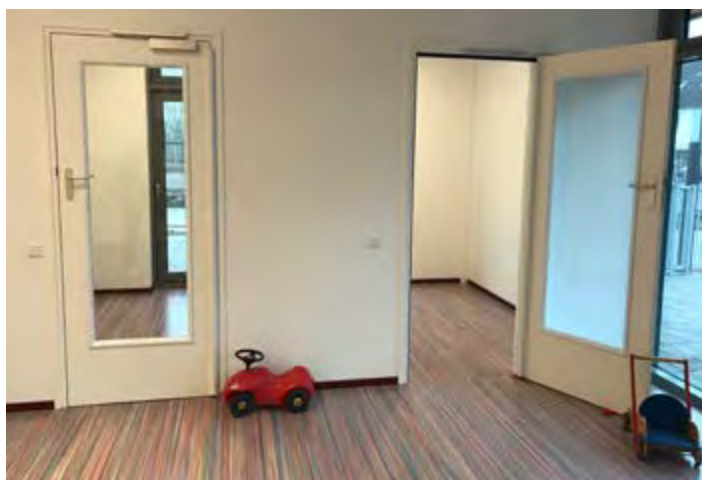

Finger Alert Extreme

Create a safe environment for children in kindergartens and schools with the Finger Alert Extreme. Doors with an extreme wide opening can easily be made child safe with this professional security system. The Finger Alert Extreme covers the inside of the door to prevent finger entrapment.

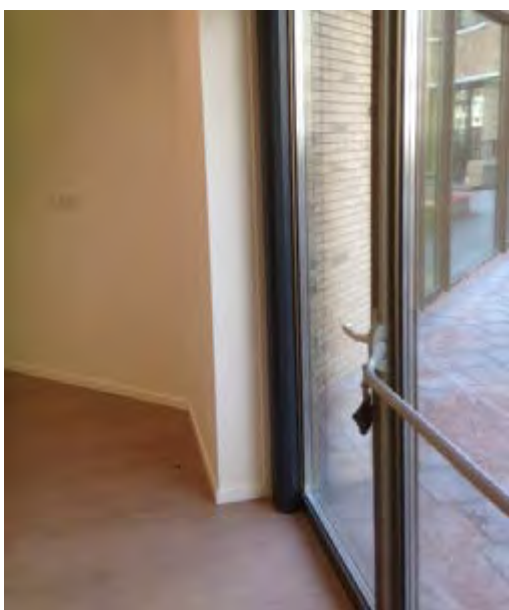



Corner Guard Deluxe ▶

A collision with a sharp angle or edge can have serious consequences for children. The robust material of the Corner Guard Deluxe absorbs the heaviest crashes allowing children to come of well from an accident. These colorful corner protectors are designed for schools, kindergartens and playgrounds to shield sharp corners or edges, both inside and outside. In an environment where children are playing we have an accident waiting to happen, therefore Corner Guard protectors are essential.



Corner Guard Pencil ▲

The playful design of the Corner Guard Deluxe Pencil makes this corner protector a true eye-catcher. This weatherproof pencil is the ideal corner protection for schools, kindergartens and playgrounds. A fall against a sharp edge or corner easily results in a visit to the doctor. Avoid nasty injuries by protecting dangerous corners and edges with the Corner Guard Pencil



Corner Guard Industrial ▲

Heavy crashes in parking areas and warehouses are absorbed by the sturdy Corner Guard Industrial with an integrated aluminum plate. The reflective marking on the corner protector makes this Corner Guard Industrial visible in a dark environment. The internal aluminum layer provides additional protection on the corner where the industrial protection is mounted, avoiding serious damage to vehicles or the environment.



Corner Guard Standard ▲

Due to its unique design, the Corner Guard Standard is unobtrusive, but it offers the desired protection and sturdiness. Within our range these corner protectors are particularly suitable for hospitals. The three colors make this corner protection ideal for various locations where a less eye-catching corner protector is desired. Create a safe environment and reduce the risk of serious injuries by falling or bumping with these corner protectors.



Corner Guard Table ▲

You want to protect children from sharp corners on a table? The Corner Guard Table is a simple solution to prevent injuries from falling or bumping into tables creating a child safe table with round corners. Mount these table corners easily with 3M tape on plastic, glass, wooden and metal tables. Both consumers and professionals create a child safe environment by installing the Corner Guard corner bumpers on sharp-edged tables. child safe table corner mount on plastic, glass, wood and metal easy fix avoid injuries from falling or crashing corner protection for tables.

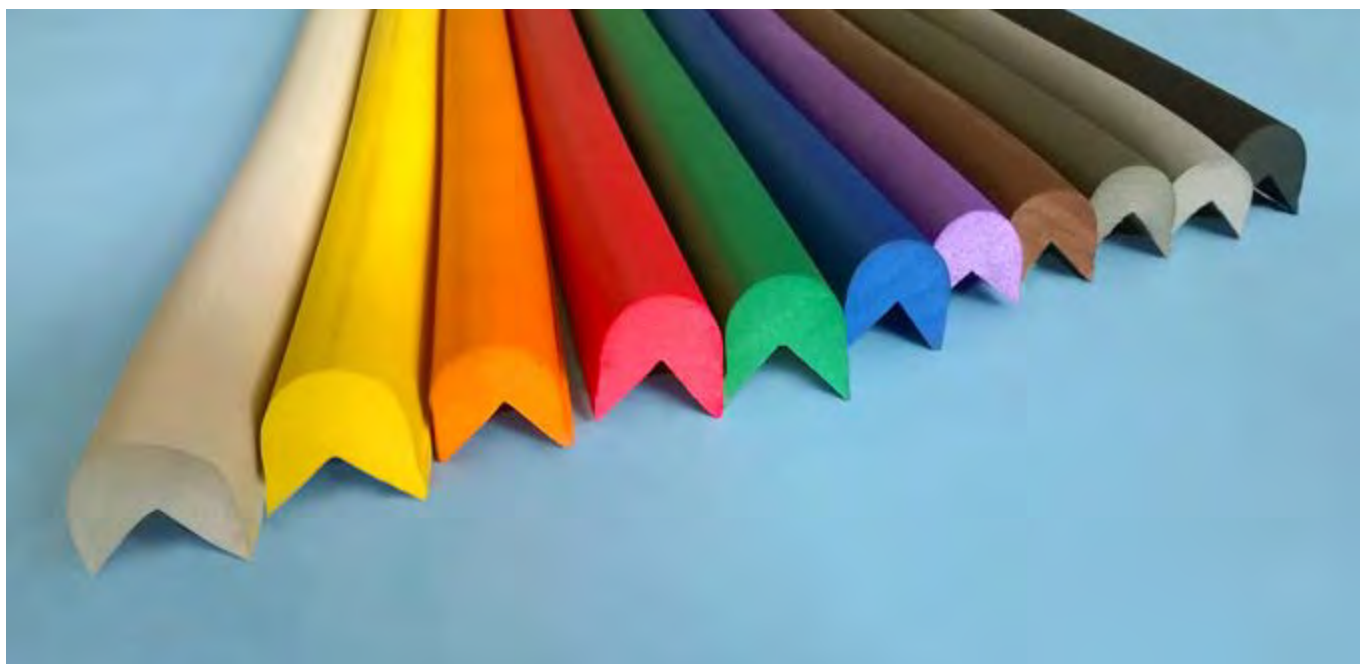

Hot Dog ▶

Hot Dog Edge Model HOT DOG

With U-shaped is used to protect edges, shelves, and glass tables. It can also be fixed by pressure, with double-sided adhesive.

Size: W 3cm, L 100 cm or 200 cm, H 90cm.





Maxionda ▶

Maxionda was designed to satisfy any type of protection's requests for any type of danger. It can be used especially in sports, or in places where the impact risk is very high and very dangerous. Thanks to its great versatility it adapt to any type of support. Closed cell material of high strength and elasticity with a very high quality of shock-absorption. Repellent to all substances, anti-mold and anti-bacterial. Particularly suitable for indoor and outdoor use: sports facilities, gyms, schools, gardens, industry





Onda ▶

Onda was designed to satisfy any type of protection's requests for any type of danger. It can be used especially in sports, or in places where the impact risk is very high and very dangerous. Thanks to its great versatility it adapts to any type of support. Closed cell material of high strength and elasticity with a very high quality of shock-absorption. Repellent to all substances, anti-mold and anti-bacterial. Particularly suitable for indoor and outdoor use: sports facilities, gyms, schools, gardens, industry



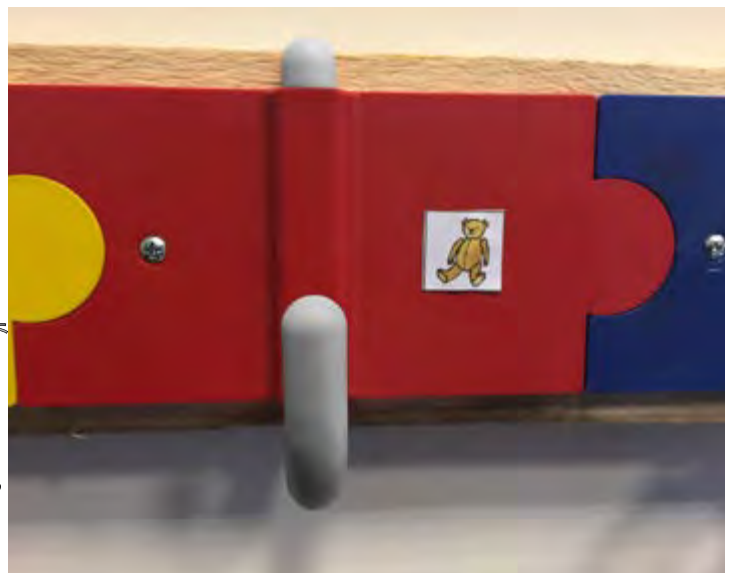

Soft Coat Hook ▶

The 'Safe Coat Hook' is a child-proof hook. The hook is made of flexible material so children will not have any head injuries when they bump into the coat rack. It also characterized by its child-friendly design; The puzzle pieces have different bright colors and can be labeled with a (name) sticker. The hooks make the hanging of coats fun and safe for children making them essential for childcare centers, nurseries, elementary schools and even homes!

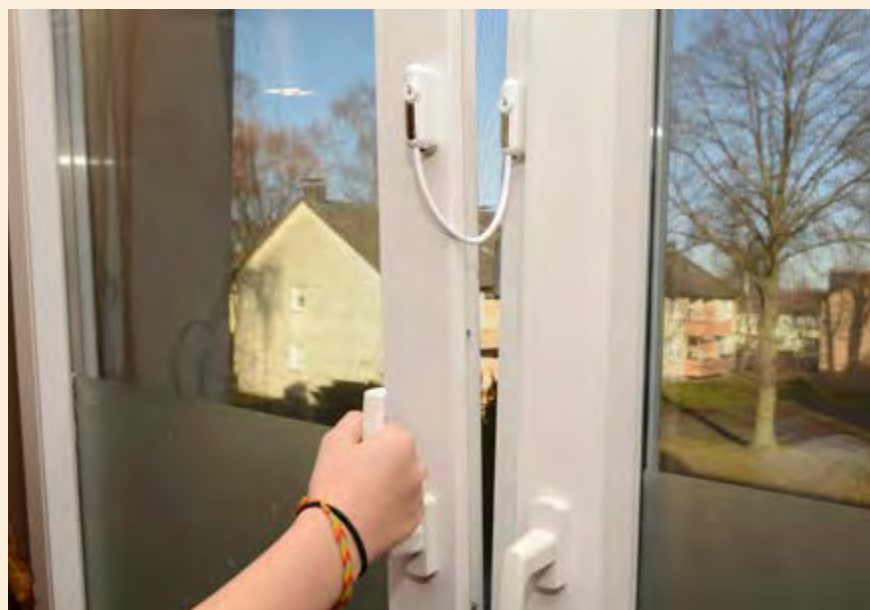

◀ Window Alert

This window protection is a simple solution to limiting the opening of the window, so that children cannot climb or fall through it. The Window Alert window protection makes the house safe for children and secures the house against any burglary. The Window Alert has two enclosures with lock. The spring on the plate keeps the Window Alert in place. Secure the window by closing the covers and remove the key. With this protection, the window can only be opened 10 cm. Remove the safeguard to open the window completely.

2D Shapes	76	Chenille Stems – Standard Colours	52	Dough Characters	50
2D/3D Geo Shape Flip Chart	93	Children Kitchen Play	238	Dough Extruder	49
2D/3D Geometric Solids	94	Children Lounge	124	Dough-It' Extrusion Machine	49
3D Cubes	69	Chilling Bag Lounge	243	Dramatic Play	122
6 Well Muffin Palette	39	Circle	98		
9 Well Muffin Palette	39	Circleline Twin Taxi	160	E	
		Circular Sand and Water Tray	163	187 Easel & Play Screen	240
A		Classic Chair	187	Easi-Grip 4 in 1 Pattern Roller	49
Acrylic Storage Units	224	Classic Plus Chair	187	Educational Carpets	138 - 147
Activity Play Table	231	Classic S Chair	206	Educational Toys	54
Activity Rings	152	Classic Tables	70	Elastics Ropes	152
Addition Strip Board	115	Classification Box	30	Elegance Chair	188
Additional Chart & Tiles	114	Classroom Acrylic Paint	64	Elegance Stool	188
Adhesive Black & White Eyes	52	Clothes for Threading	231	Elegance Storage Units	228
Adhesive Coloured Eyes	52	Coat Locker Unit	74	Elegance Tables	204
Adhesive Mouths	52	Color Hunt	77	Emotions Pouf	155
Adhesive Noses	52	Color Paddes	58	EN10 Series Chair	193
Air Drying Clay Terracotta	51	Colored Big Blocks	24	EN11 Series Chair	193
Air Drying Clay White	51	Colored Cool Cars Car	24	EN12 Series Chair	193
Alphabet Bean Bags	80	Colored Cool Cars School Bus	24	Energetic Play	148
Alphabet Board	80	Colored Cool Cars Train	24	Equipment Trolley	230
Alphabet Board(Arabic)	82	Colored Cool Cars Truck	24		
Alphabet Upper Case Stencil	44	Colored Cool Cars Van	108	F	
Animal Mask	130	Colored Pencil Holder	57	240 Face & Body Crayons	34
Animal Pattern Rocker Stampers	49	Coloured Window Blocks	240	60 Face & Body Paint	34
Anti Slip Steps	264	Colourful Easel	60	226 Faces and Expressions	72
Arabic Alphabet Blocks	85	Color Mosaic	19	19 Fairy Tales	66
Arts & Crafts	28	Comby Storage Units	106	106 Finger Alert 110°	266
Attribute Blocks	93	Construction Rabbits	238	238 Finger Alert Door Blocker	265
		Constructive Triangles	268	268 Finger Alert Extreme	267
		Cooker	269	269 Finger Paint	32
		Corner Guard Deluxe	268	268 First Sorting Kit	90
		Corner Guard Industrial	269	269 Flexo L Chair	191
		Corner Guard Pencil	269	269 Flexo N Chair	191
		Corner Guard Standard	88	88 Flexo Storage Units	216 - 223
		Corner Guard Table	90	90 Flexo Tables	200
		Counters	91	91 Flip Around Chair	194
		Counting & Sorting Set	88	88 Florescent Liquitemp Classroom Poster	
		Counting Abacus	40	40 Paint	31
		Counting Sticks	40	40 Fluoro Rainbow Paint	33
		Craft Clear Gum	46	46 Follow the Fish	65
		Craft PVA Glue	234	234 Foot Twister	158
		Cream of Tartar	192	192 Fraction Domino	121
		Curved Storage Box Units	210	210 Fridge	238
		Curvy Chair	186	186 Fruit Dough Cutters	50
		Curvy Tables	103	103 Fun Cart	158
		Curvy Woody Chair		Fun Dough	46
		Cylinder Blocks		Fun Dough Accessories	50
				Fun Dye	32
B		D		188 Fun Pretend Clothes Rack	126
Baby Stubby Brush	37	Deluxe Chair	229	Fun Pretend Iron Set	126
Balance Palm Tree	121	Deluxe Storage Units	119	Funny Circular Sorter	26
Basic Building Blocks	56	Desert Village	163	Funny Face Shapes	21
Basic Geometric Volume Set	94	Desktop Water Tray	163	Funny Shapes Board	26
Basic Grammar Symbols	110	Desktop Water Tray Stand	26		
Bean Bags	242	Discover Who's Bigger ? Chick	26	G	
Ben Hur Tricycle	157	Discover Who's Bigger ? Frog	26	26 Geo Fun	92
Benches	196	Discover Who's Bigger ? Ladybird	26	26 Geo Links	89
Best Value Crayons - Box of 800	42	Discover Who's Bigger ? Rabbit	26	114 Geo Pegs and Peg Board	23
Bicycle	156 + 161	Discover Who's Bigger ? Star	265	265 Geoboards 6	65
Bike Runner	156 + 161	Division Charts & Tiles	231	231 Geoland	61
Boards	241	Door Stopper	240	240 Geometric Fractions	68
Brown Stairs	102	Double Sided Display Book Unit	240	240 Geometric Solids	94
Brush Set	37	Double Sided Easel	240	240 Geometrical Peg Grading Board	68
Build & Balance (Advanced Set)	153	Double Sided Metal Easel With Trays			
Build & Balance (Starter Set)	153	Double Sided Wooden Easel With Trays			
Build Up Abacus	90				
Building Blocks Farm	19				
Building Blocks Jungle	19				
Building Up Body Parts Puzzles	66				
C					
Camel's Fun	121				
Camels' Caravan	120				
Candy Chair	192				
Captin Chair	195				
Cause and consequence	72				
Ceramic Steel Surface Magnetic With Wood Frame	241				
Chalk Board With Wood Frame	241				
Chenille Stems – Black	52				
Chenille Stems – Neon Colours	52				
Chenille Stems – Pastel Colours	52				

S	
Safety Products	262
Sand and Water Tray	162
Sandy Clay	48
Scooter, small	156 - 160
Screw Heads	20
Screwdriver & Nails	107
Sea Life Stencils	44
Seesaw	150
Shape Link Activity Set	89
Shape Matching Board	68
Shape Sorting Box	71
Shapes Mosaic	61
Shapes Small Truck	23
Simple Chair	190
Simple S Chair	190
Single Shape Puzzle Set	98
Skeletal Geo Set	95
Skeletal Starter Geo Set	95
Small Buttons	62
Small Numerals 1 - 9000	112
Small Shoes	64
Small Sorting Box	71
Soft Coat Hook	273
Soft Rocking Items	154
Sorting Box	70
Spell - A - Word	81
Spell - A - Word(Arabic)	83
Spindle Box	111
Squared Domino	73
Squares and Rectangles	98
Squares and Triangles	98
Stacking Counters	91
Stacking Rings Snail	21
Stacking Tower	65
Stage	236
Star Chair	186
Stool	195
Student Math Balance	92
Student Number Line 0100- Pack of 10	92
Subtraction Charts & tiles	114
Subtraction Strip Board	115
Super Beads	53
Super Dough	48
Surprise Window Circles	26
Surprise Window Shapes	26
T	
Teen Boards	113
Tens Boards	113
Texture Wands Set 1	35
Texture Wands Set 2	35
The Finger Alert 170-- 180°	267
The Palace Blocks	118
The Wobbly Kid	21
The Wobbly Man	21
Theatres	127
Threading Animals	63
Tie Me Up! Giant Shoe	64
Toddler Chair	194
Toddler Cute Animal Car Bunny	25
Toddler Cute Animal Car Cow	25
Toddler Cute Animal Car Crocodile	25
Toddler Cute Animal Car Puppy	25
Toddler Cute Animal Car Tiger	25
Toddler Grading Shapes	23
Toddler Stool	195
Toddler Tracking Board (Lev 1)	27
Toddler Tracking Board (Lev 2)	27
Toddler Tracking Board (Lev 3)	27
Touch & Feel Pond	26
Touch & Match Dominos	73
Tower Stacking Rings	21
Transport Stencils	44
Triangle Abacus & Tracing	91
Tricycle Large	159
Tricycle Medium	159
Tricycle Small	159
Trip To	69
Tris Tras	62
Truck	157
Twin Taxi	157
Twist It Crayons	43
U	
Ultimate Storage Units	225
Ultra Tables	208
V	
Vertical Chess	74
Viking Kangaroo	158
Vowels For Threading	80
W	
Wall Number Line 0-100 & Pen	92
Washable Water Colours	32
Washing Machine & Sink	238
Water Based Gloss Varnish 50ml	51
Water Pot	38
What are You Doing ?	67
What's Inside My Alphabet ?	80
What's Inside My Alphabet ?(Arabic)	82
What's Inside My Numbers?	91
Where is My Button?	74
Which is the Tallest .. ?	68
Window Alert	273
Wooden Fences	239
Wooden Hundred Square	112
Wooden Thousand Cubes	112
Woody Chair	186
Würfel	244

UAE**Head Office**

Dubai, UAE

*Building C, Office No. 259,
Business Park, Dubai World Central*

Showroom

Sharjah, UAE

*No.1, ASAS Building, Maliha Rd,
Industrial Area 18*

Tel: +971 6 554 5278,

Cell: +971 50 462 2134

uae@edu-fun.com

www.edu-fun.com

EGYPT Cairo**Madinet Nasr, Cairo, Egypt**

Tel. : +(202) 2270 7649

Fax : +(202) 2270 7571

info@edu-fun.com

Germany

Rheinstrasse 7,

77743 Neuried-Ichenheim

Tel. : +49 (0)7807/989315-0

www.edufun.de

Website

www.edu-fun.com

Feeling Social ?



Head Office

Dubai, UAE

Building C, Office No. 259, Business Park, Dubai World Central

Showroom

Sharjah, UAE

No.1, ASAS Building, Maliha Rd, Industrial Area 18

Tel: +971 6 554 5278, Cell: +971 50 462 2134

uae@edu-fun.com, www.edu-fun.com